

# General catalog



2015  
2016

*Measure up*



---

Remote data retrieval from meters  
Energy saving  
ISO 50001  
Energy rebilling  
EN 50160 metering plan

---

Analysis of electrical disturbances  
Reduction of penalties  
Optimization of subscribed power  
Protection of the industrial process

---

High-accuracy measurement  
Network supervision  
Severe environment  
Multi-function  
Precise display

---

High rupture capacity  
Rail applications - Nuclear qualification  
Control of critical automatic systems - EMC immunity

---



# GENERAL TABLE OF CONTENTS

## Energy performance

Energy meters and power monitors p. 6



Data loggers and software p. 56



## Energy quality

Network analyzers p. 78



Current transformers and shunts p. 102



## Measurement and instrumentation

Transducers p. 152



Digital panel meters  
Graphic recorder  
Synchrocoupler p. 188



Analog panel meters p. 218



## Automation relays

Automation relays p. 238



## Index

p. 242

ENERGY METERS  
AND POWER  
MONITORS

DATA LOGGERS  
AND SOFTWARE

NETWORK  
ANALYZERS

CURRENT  
TRANSFORMERS  
AND SHUNTS

TRANSDUCERS

DIGITAL PANEL METERS  
GRAPHIC RECORDER  
SYNCHROCOUPLER

ANALOG  
PANEL METERS

AUTOMATION  
RELAYS

INDEX



# About the CHAUVIN ARNOUX Group

The Chauvin Arnoux Group and Enerdis

Founded in 1893 by **Raphaël Chauvin and René Arnoux**, **CHAUVIN ARNOUX** is an expert in measurement of electrical and physical quantities in the industrial and tertiary sectors.

**Total control of product design and manufacturing** in-house enables the Group to propose its customers a very broad product and service offering which meets all their needs.

**The Group's quality policy** ensures that the products delivered comply with its commitments and with both the national and international standards in terms of metrology, the environment and user safety

## A few figures

<b>100</b> million euros in sales revenues
<b>10</b> subsidiaries spread across the world
<b>900</b> staff
<b>7</b> production sites
<b>6</b> R&D departments worldwide
<b>11%</b> of revenues invested in R&D

## CHAUVIN ARNOUX

is a major force on the measurement market in **France** and **internationally**.

### 7 PRODUCTION SITES

- 3 in Normandy (France)
- 1 in Lyon (France)
- 1 in Milan (Italy)
- 1 in Dover (USA)
- 1 in Shanghai (China)

### 10 SUBSIDIARIES WORLDWIDE

- Germany
- Austria
- China
- Spain
- Italy
- Lebanon
- Sweden
- Switzerland
- United Kingdom
- United States

### 4 FRENCH COMPANIES

promoting the product and service offering

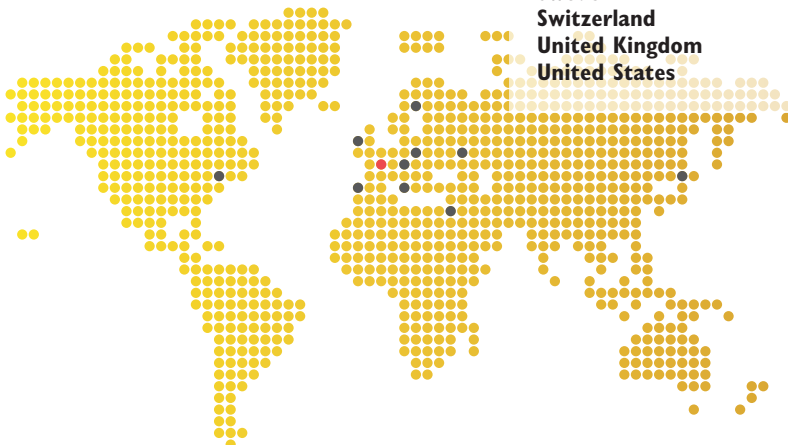
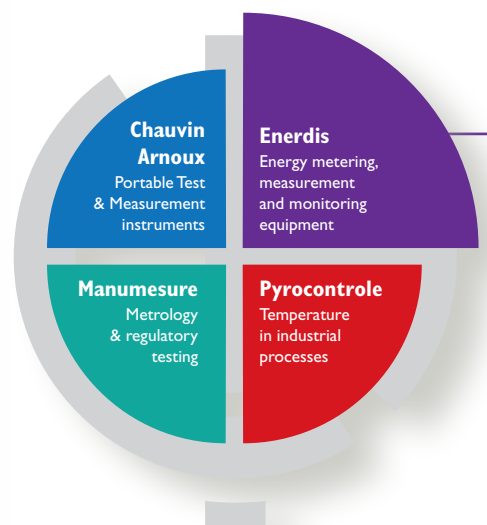

Enerdis completes the Chauvin Arnoux Group's global offering by designing permanent measuring equipment for electrical installations. Enerdis is a French company which is an expert in energy intelligence, specializing in fixed equipment for measurement, testing and supervision of electrical networks and energy systems.

A precursor in energy management, Enerdis proposes global expertise from help with diagnostics through to the implementation of complete solutions (products, software and services) adapted to each type of environment (industrial, tertiary, building). These systems comply with the international regulatory and standardization framework.

Its extensive offering of products and systems enables Enerdis to cover all the measurement requirements from the energy production site through to the point of consumption by integrating all the transmission networks and distribution systems.

## SOLUTIONS FOR EACH MEASUREMENT REQUIREMENT

From energy supply through to its distribution on site

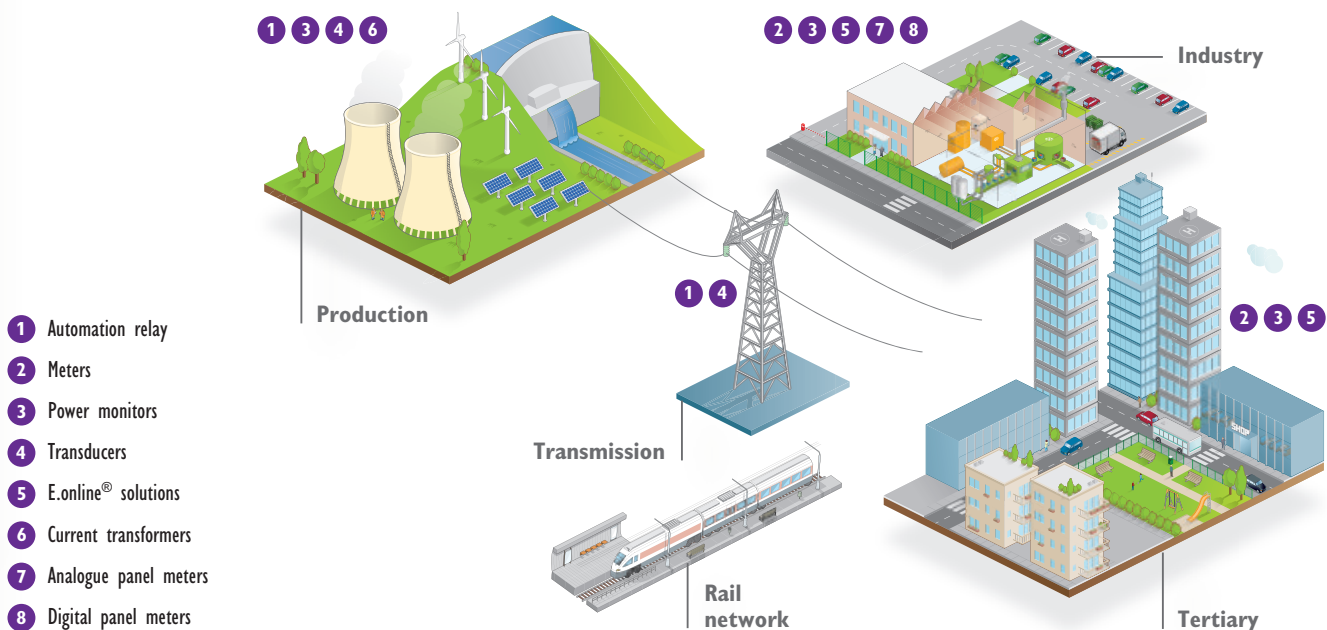

## FROM ELECTRICAL MEASUREMENT TO ENERGY PERFORMANCE MANAGEMENT

Every year in the Engineering Department at Antony (France), where the company has its Head Office, innovative products are developed in fields such as metering (tariff meters or submeters), electrical network supervision and quality (power monitors, analyzers, etc.), communication systems and software to supervise energy flows.

- Energy performance
- Power quality
- Automation relays
- Measurement and instrumentation



# Energy efficiency:

Energy performance project

**Measurement plays a key role** in the definition, success and long-term performance of an **energy optimization approach**.

That's why it is crucial not to skip any of the steps involved, which are applicable in the context of:

- an energy performance contract handled by an external service company
- an “energy plan” handled in-house by company staff.

## Chauvin Arnoux - One-off measurements

### 1 DIAGNOSTICS

- ▶ **Analyze** energy bills in order to identify:
  - energy-hungry installations
  - production processes
  - the cost structure
  - the existing organization
- ▶ **Acquire** knowledge of the installation by one-off measurements so that you can determine the types of energy and utilities to be managed and the specific target (in €) to be reached.

### 2 DETAILED ANALYSIS

- ▶ **Analyze** the behaviour of the installations very precisely by **long-term measurement campaigns** leading to a detailed audit which then serves as the reference for a **Measurement and Verification Plan (MVP)**
- ▶ **Assess** the potential energy savings and **determine** the minimum requirements by:
  - improving the power factor
  - carrying out a power survey with measurement of the energy consumed
  - searching for heat losses

▶ *Instruments for one-off measurements:*  
wattmeter • infrared camera • light meter

▶ *Instruments for measurement campaigns:*  
network analyzer • infrared camera • light meter • hygrometer • plug & play recorder





# the 4 phases of the approach

The methodology usually followed is divided into **four phases**, each including a precise objective, clearly-identified actors and detailed specifications of the deliverables.

One of **Enerdis's** missions is to accompany its contacts, whether customers or expert channels, in this process in order to offer them solutions which match their requirements in the context of a **global, long-term approach**.

## Enerdis - Permanent measurement system

### 3 IMPLEMENTATION

- ▶ Set up a **global energy management solution** for energy control of the whole installation.
- ▶ Propose **suitable solutions for each requirement**.

### 4 MANAGEMENT & MAINTENANCE

- ▶ **Support the approach** by adapting the system to any specific local features and integrating the approach into an existing system. **Commissioning assistance** and **user training** are also provided and a system maintenance contract is proposed.

## Measurement and Verification Plan (MVP)

- ▶ **Complete, renovate or install a permanent measurement system** for longer-lasting performance.  
*E.online system • Network analyzer • energy meters • power monitors • graphic recorder*  
**Solutions:** power factor correction • harmonic filtering • power control • temperature control and sensors.



All **Chauvin Arnoux** Group products sold under the **Chauvin Arnoux**, **Enerdis** and **Pyrocontrole** brands are ideal for use at all levels of the energy value chain, whatever the sector of activity (building, infrastructure, industry and residential), **guaranteeing performance and comfort**.



# Energy meters and power

▶ Energy performance

## Energy meters

### Single-phase

With communication

MEMO4 Modbus  
45 A direct input  
Class 1 - MID

▶ page 22



ULYS MD80  
80 A direct input  
Class 1 - MID

▶ page 26



Without communication

MEMO3  
32 A direct input  
Class 1 - MID

▶ page 20



MEMO4  
45 A direct input  
Class 1 - MID

▶ page 22



ULYS MD65  
65 A direct input  
Class 1 - MID

▶ page 24



### Three-phase

With integrated communication

ULYS TD80  
80 A direct input  
Class 1 - MID

▶ page 28



ULYS TT  
CT connection  
Class 1 - MID

▶ page 30



Without integrated communication

ULYS TDA80  
80 A direct input  
Class 1 - MID

▶ page 32



ULYS TTA  
CT connection  
Class 1 - MID

▶ page 34



## Communication modules

ULYSKOM  
für ULYS MD80 - TDA80 - TTA  
▶ page 36



# monitors

## Power monitors

Flush mounting  
96 x 96

ENERIUM 30  
▶ page 38



ENERIUM 50  
▶ page 38



ENERIUM 150  
▶ page 38



Flush mounting  
144 x 144

ENERIUM 100  
▶ page 38



ENERIUM 110  
▶ page 38



ENERIUM 200  
▶ page 38



ENERIUM 210  
▶ page 38



ENERIUM 300  
▶ page 38



ENERIUM 310  
▶ page 38



## Associated software

E.SET  
Configuration software  
▶ page 49



E.VIEW  
Configuration and  
diagnosis software  
▶ page 50



E.VIEW+  
Configuration, diagnosis  
and display software  
▶ page 51

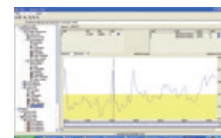

## Metering solution

RENOV ENERGY  
▶ page 52





# Quick selection guide for meters

Energy performance Energy meters and power monitors

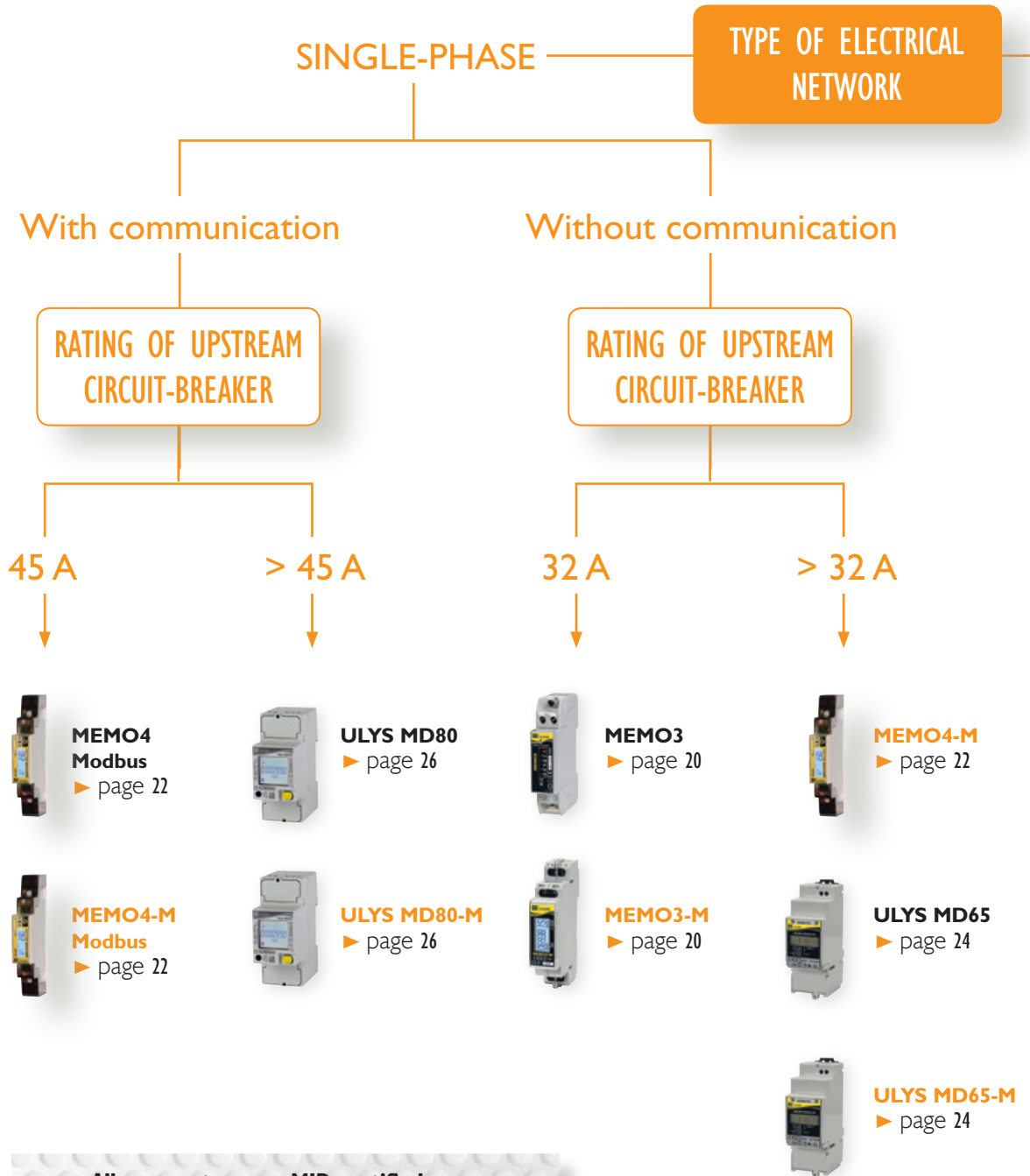

 **All our meters are MID-certified. References end is "-M", such as MEMO4-M, are fully comply with the MID.**



THREE-PHASE

With integrated communication

Without integrated communication

RATING OF UPSTREAM  
CIRCUIT-BREAKER

RATING OF UPSTREAM  
CIRCUIT-BREAKER

80 A

> 80 A  
on TC

80 A

> 80 A  
on TC



**ULYS  
TD80**  
▶ page 28



**ULYS  
TT**  
▶ page 30



**ULYS  
TDA80**  
▶ page 32



**ULYS  
TTA**  
▶ page 34



**ULYS  
TD80-M**  
▶ page 28



**ULYS  
TT-M**  
▶ page 30



**ULYS  
TDA80-M**  
▶ page 32



**ULYS  
TTA-M**  
▶ page 34



# Product selection guide by functions

▶ Energy performance Energy meters and power monitors

## Energy meters

▶ page 20

▶ page 22

▶ page 24



**MEMO3**  
**MEMO3-M**



**MEMO4**  
**MEMO4-M**



**ULYS MD65**  
**ULYS MD65-M**

			MEMO3 MEMO3-M	MEMO4 MEMO4-M	ULYS MD65 ULYS MD65-M
<b>Strengths</b>			1 module MID version	1 module MID version Modbus Communication	2 modules MID version
	Network		<b>LV</b>		
Rating			<b>32 A</b>	<b>45 A</b>	<b>65 A</b>
MID certified			MEMO3-M	MEMO4-M MEMO4-M Modbus	ULYS MD65-M
Accuracy class			IEC Class 1 / MID Class B		
<b>Installations</b>	Mounting	Modular (DIN modules)	1 module		2 modules
	Network	Single-phase			
		Three-phase			
	Current input	Direct			
On CT					
<b>Energy metering and management</b>	Total energy	Display	kWh total	kWh, kVArh, kVAh total & partial	kWh total
		Communication		MEMO4 Modbus MEMO4-M Modbus	
	Tariff				
<b>Multi-measurement</b>	Electrical parameters	Display		inst, V, U, I, P, Q, S, F, FP, ΣP, ΣQ, ΣS	
		Communication		inst, V, U, I, P, Q, S, F, FP	
<b>Input-output</b>	Pulse output(s)		1		
	Tariff change input				
<b>Communication</b>	RS485 port			MEMO4 Modbus MEMO4-M Modbus	
	Ethernet Modbus				
	M-bus				
<b>Metrology</b>	V/U/I				
	P/Q/S				
	Eact		IEC: class 1 / MID: class B		
	Ereact				

Energy meters

▶ page 26

▶ page 32

▶ page 34

▶ page 28

▶ page 30



**ULYS MD80**  
**ULYS MD80-M**



**ULYS TDA80**  
**ULYS TDA80-M**



**ULYS TTA**  
**ULYS TTA-M**



**ULYS TD80**  
**ULYS TD80-M**



**ULYS TT**  
**ULYS TT-M**

Multi-communication protocols Multi-measurement MID version		Multi-communication protocols Multi-measurement MID version		Multi-communication protocols Multi-measurement MID version		4 modules Integrated communication MID version		4 modules Integrated communication MID version	
<b>LV</b>									
<b>80 A</b>				<b>on CT</b>		<b>80 A</b>		<b>on CT</b>	
ULYS MD80-M		ULYS TDA80-M		ULYS TTA-M		ULYS TD80-M		ULYS TT-M	
IEC class 1 / MID class B									
2 modules		4 modules							
		3/4 wires				3/4 wires*			
		Insulated				Insulated			
kWh, kVArh, kVAh total & partial						kWh, kVArh, kVAh total & partial			
2 tariffs						2 tariffs			
inst, V, U, I, P, Q, S, F, FP, ΣP, ΣQ, ΣS						inst, V, U, I, P, Q, S, F, FP, ΣP, ΣQ, ΣS			
inst, V, U, I, P, Q, S, F, FP		inst, V, U, I, P, Q, S, F, FP, ΣP, ΣQ, ΣS				inst, V, U, I, P, Q, S, F, FP, ΣP, ΣQ, ΣS			
2						1			
1						1*			
via ULYSCOM communication modules						ULYS TD80 Modbus / -M		ULYS TT Modbus / -M	
						ULYS TD80 Ethernet / -M		ULYS TT Ethernet / -M	
						ULYS TD80 M-bus / -M		ULYS TT M-bus / -M	
0,5 %									
1 %									
IEC: class 1 / MID: class B									
IEC: class 2									

\* depending on model



# Quick selection guide for power

Energy performance **Energy meters and power monitors**

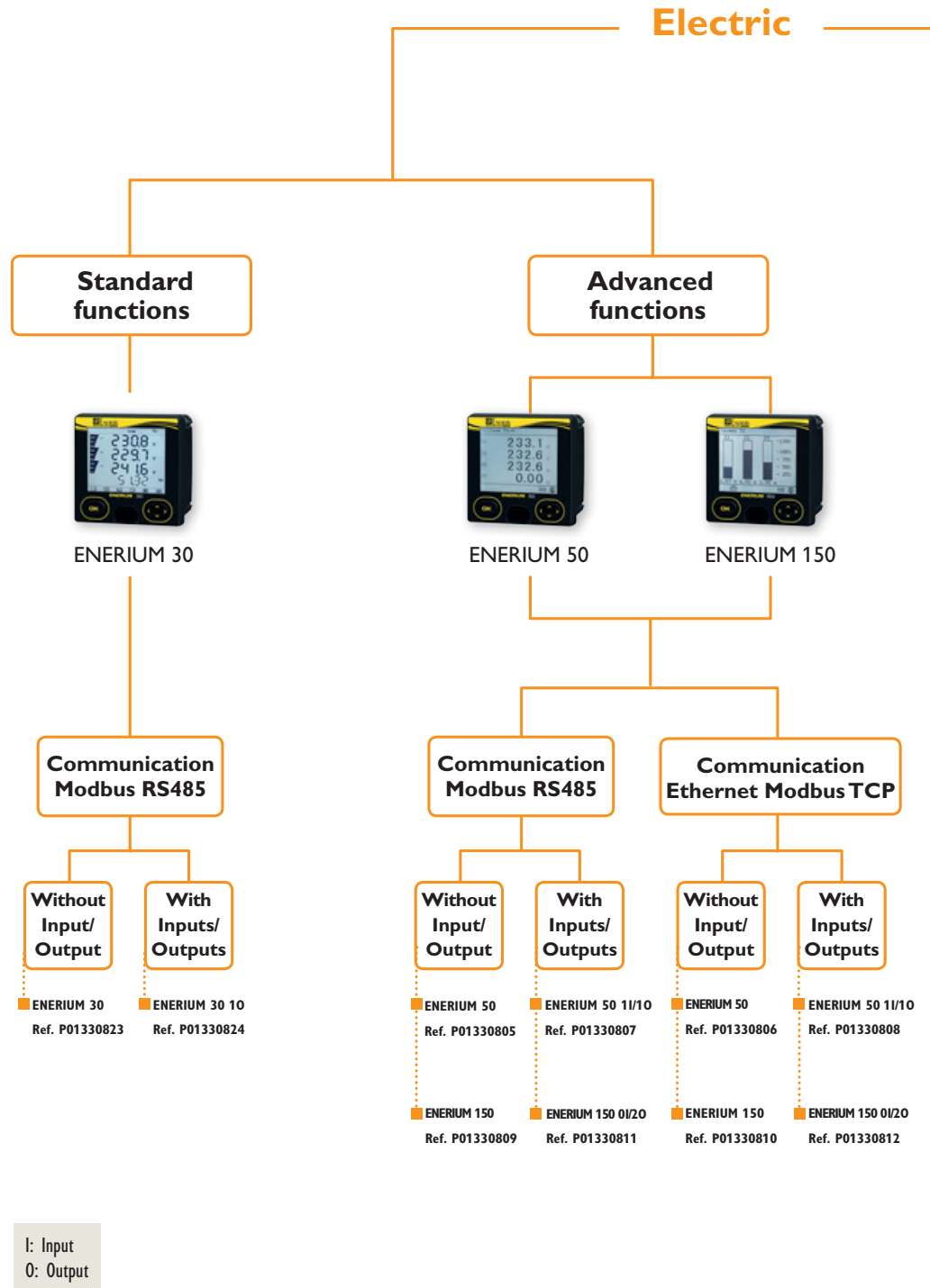



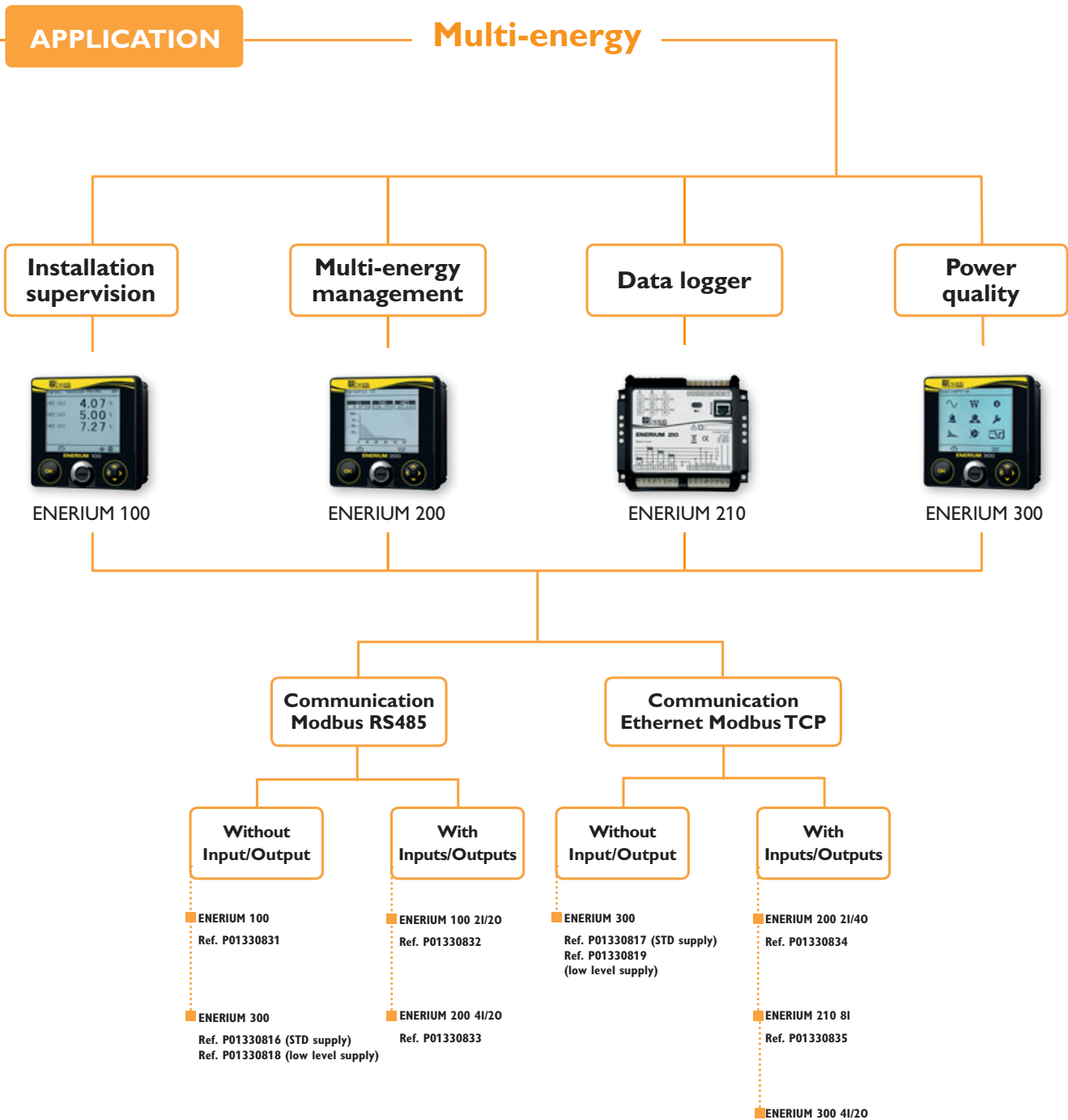



# Choosing your power monitor

Energy meters and power monitors

Energy performance

## Power monitors

▶ page 38

▶ page 38

▶ page 38



**Enerium 30**



**Enerium 50**



**Enerium 150**

		Enerium 30	Enerium 50	Enerium 150
<b>Electrical energy management</b>	Accuracy	1 %	0.5 %	0.5 %
	Measurement of V, U, I Inst. Min/Max Avg.	■	■	■
	Measurement of P, Q, S Inst. Min/Max Avg.	■	■	■
	Energy produced and consumed	■	■	■
	Consumption curves (10 min. avg. values)	-	8	8
<b>Multi-energy management</b>	Pulse inputs for other meters (water, gas, etc.)	-	0, 1 or 2	0, 1 or 2
	Inputs for analogue quantities (temperature, flow rate, pressure, insolation, etc.)	-	-	-
<b>Installation supervision</b>	Trend curves	-	-	4
	Management of alarms on thresholds	2	16	16
	Alarms log (recordings)	-	64	64
	Fresnel diagram	-	-	■
	Pulse or alarm outputs	0 or 1	0, 1 or 2	0, 1 or 2
	Analogue outputs	-	0 or 2	0 or 2
<b>Power quality</b>	THD / PF / Tan φ	■	■	■
	Harmonics by order with graphic representation	-	25	50
	Wave capture (U, V, I, In)	-	-	-
	EN50160 analysis	-	-	-
	Max. no. of input + output options	1	2	2
RS485 – Modbus	■	■	■	
Ethernet – Modbus TCP	-	■	■	
Format (mm)	96 x 96	96 x 96	96 x 96	
Screenless version available	-	-	-	

Power monitors

▶ page 38



**Enerium 100**

▶ page 38



**Enerium 200**

▶ page 38



**Enerium 300**

0.5 %	0.2 %	0.2 %
■	■	■
■	■	■
■	■	■
-	8	8
0, 2, 4, 6 or 8	0, 2, 4, 6 or 8	0, 2, 4, 6 or 8
0, 2, 4, 6 or 8	0, 2, 4, 6 or 8	0, 2, 4, 6 or 8
4	4	4
16	16	16
64	64	64
■	■	■
0, 2, or 4	0, 2, or 4	0, 2, or 4
0, 2, 4, 6 or 8	0, 2, 4, 6 or 8	0, 2, 4, 6 or 8
■	■	■
25	50	50
-	-	16
-	-	■
8	8	8
■	■	■
■	■	■
144 x 144	144 x 144	144 x 144
ENERIUM 110	ENERIUM 210	ENERIUM 310



## WHAT IS THE MID?

The MID (Measuring Instruments Directive - 2004/22/CE) is a European Directive issued in 2004 which applies to devices and systems with a measuring function in order to protect the interests of consumers, particularly in the context of commercial transactions.

These measuring instruments may be active electrical energy meters (Annex MI003 of the Directive), water, gas or heat meters, weighing instruments, etc.

## Scope

The MID covers three types of usage: "Measurements of residential, commercial and light industrial use". A minimum meter accuracy class is imposed for each usage category as stipulated in the Directive 2004/22/CE:

- Where a Member State imposes measurement of residential use, it shall allow such measurement to be performed by means of any Class A meter. For specified purposes the Member State is authorized to require any Class B meter.
- Where a Member State imposes measurement of commercial and/or light industrial use, it shall allow such measurement to be performed by any Class B meter. For specified purposes the Member State is authorized to require any Class C meter.

The MID does not however apply to "Energy meters on which the [Ph-Ph] voltage between the connection terminals exceeds 600 V"

## Regulatory Context

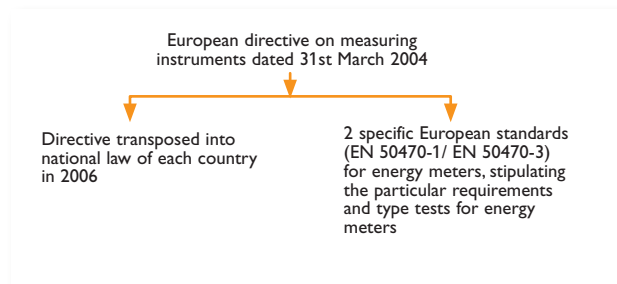



## CONDITIONS OF APPLICATION

In the European Union, the use of MID-certified meters on “private”<sup>(1)</sup> electrical networks has been made mandatory in the context of active energy billing based on consumption readings by index differences.

Typical examples include: camping sites, holiday rentals, student accommodation, office buildings, shopping centres, marinas, exhibition halls, electric vehicle recharging stations, etc.

As the MID is applicable to all European Union Member States, certification of ammeter by a Notified Body (NB) means that no other testing by a national legal metrological service is required. So a MID-certified Enerdis meter can be used as an active energy billing meter in all European Union countries.

The Directive also imposes product certification according to the EN50470-1/-3 standard, as well as design certification (Module B) and manufacturing process certification (Module D) by a Notified Body, in order to ensure product traceability and guarantee its metrological value, thus helping to protect consumers.

<sup>1</sup> Downstream of the meter at the network manager's point of supply.

## ACCURACY CLASSES AND METER IDENTIFICATION

The EN50470-1/-3 defines three specific accuracy Classes: A, B and C. These are comparable to the IEC62053-21/-22 active energy metering standards:

Class A is equivalent to 2% accuracy, Class B to 1% and Class C to 0.5%.

For total compatibility with the Directive, there must be regulatory marking for meter traceability. In addition to the manufacturer's name and the product reference, this regulatory marking comprises:

- A reference to Module D certification



- A reference issued by the Notified Body certifying conformity with regard to the Module B design inspection
- The meter's serial number

A declaration of conformity is enclosed with each product sold.

## THE ENERDIS PRODUCTS CONCERNED

- All active energy meters whose references end in “M”, such as the **MEMO3-M** and **MD65-M** for example, also identified by the MID logo in our catalogue, fully comply with the MID.
- The Directive does not cover current transformers, power monitors or the additional functions (other than active measurement) offered by smart meters.



Energy meters and power monitors

▲ Energy performance

## KNOW ALL THE DETAILS: WHERE, WHEN, HOW, HOW MUCH? SUPERVISING, MANAGING AND EXCHANGING

E.online<sup>2</sup><sup>®</sup>

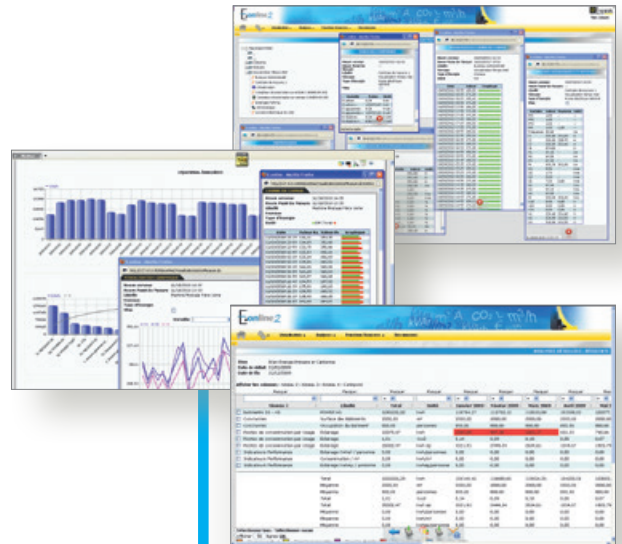

### Supervision

E.online<sup>®</sup>, a professional tool which remotely processes and analyses all the electrical data from an installation via the products associated with it.

### Metering and measurement

A full range of energy meters and power monitors that comply with the most demanding standards to ensure optimum accuracy.

### Compensation and filtering

Fixed or automatic cabinet-mounted power factor correction solutions, a hybrid system for compensation and filtering and harmonic filtering equipment.

### MULTI-UTILITY METERS



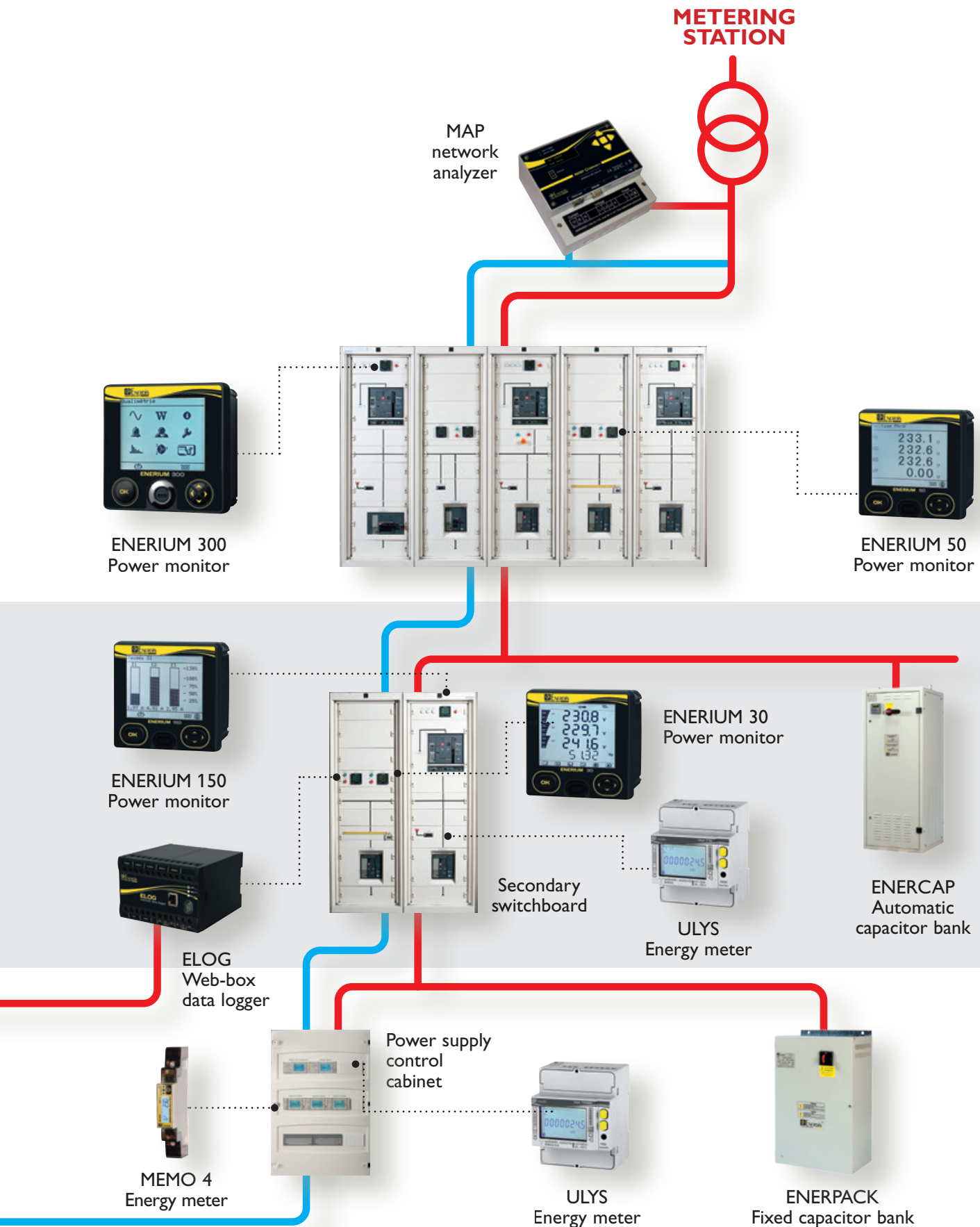



# MEMO 3 single-phase 32 A

Energy meters for single-phase networks  
32 A direct connection

Energy performance  
Energy meters

**PRODUCT ADVANTAGES**

- + 32 A nominal current
- + CLASS 1 according to IEC 62053-21 MID CLASS B according to EN50470-3
- + COMPACT: a single DIN module
- + PULSE OUTPUT as standard
- + SEALABLE on phase and neutral terminals

Backlit LCD permanent display for easy reading in low-lighting environments



MID certification



Sealable terminal covers

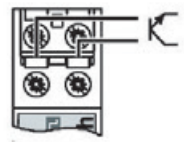

Pulse output as standard

## ► Description

**MEMO 3** is the economical solution from ENERDIS for monitoring the electricity consumption of customers on single-phase 230 V networks. Equipped with mechanical display, the **MEMO 3** offers Class 1 accuracy, in total compliance with IEC standard 62053-21.

**MEMO 3-M** is the perfectly adapted solution for rebilling electricity on private network. Fully compliant with MID standard, **MEMO 3-M** energy meter is dedicated to electricity commercial applications as campsites, marinas, holiday rentals and outdoor accommodation facilities:

- DIN rail mounting with direct connection for 32 A network
- Sealable cover (phase and neutral terminals)
- Pulse output as standard

Associated with **E.online**<sup>®</sup> energy management software, it offers remote processing of energy consumption via PC, thus enabling you to produce consumption reports automatically and establish an accurate breakdown of the energies consumed.

## ► Electrical specifications

Current input	MEMO3	MEMO3-M
Type	Single phase	
Rated current	32 A	
Istart current	20 mA	
Max. permanent current	50 A	
Max. current	20 mA	0,25 A
Voltage input		
Measurement range	0 à 99 999,9 kWh	0 à 999 999,99 kWh
Consumption	< 2 VA	active 0,4 W
Rated voltage	230 V (-10% / +20%)	230 V (-20% / +15%)
Frequency	50 / 60 Hz	50 Hz
Sortie impulsions		
Type	insulated with open-collector transistor	optocoupler 5 - 30 Vdc / 20 mA
Weight	100 imp / kWh	1 000 imp / kWh

## ► Mechanical specifications

	MEMO3	MEMO3-M
Protection rating	IP 51 on front panel	
Power circuit connection	Screw connection terminal for 6 mm <sup>2</sup> flexible wires (10 mm <sup>2</sup> for rigid wires)	
Pulse out connection	Screw connection terminal for 2,5 mm <sup>2</sup> wires Tightening torque 0.8 Nm	
Sealing system	On phase and neutral terminals	All terminals
Mounting	On 35 mm DIN rail	
Weight	100 g	70 g

## ► Environment

	MEMO3	MEMO3-M
Operating temperature	-20 °C to +50 °C	-10 °C to +55 °C
Storage temperature	-30 °C to +70 °C	-30 °C to +85 °C
Relative humidity	< 95 % to 40 °C	

## ► Screen elements

	MEMO3	MEMO3-M
Display	6 mechanical rolls Height 4 mm	LCD backlit screen Height of numbers 5 mm
Metrological led	Green flashing 3,200 times/kWh	Green flashing 2,000 times/kWh (600 ms if inversion L1/L2)
Total (kWh)	Indicates the total consumption	

## ► Associated products

Data retrieval solutions

► page 56

E.online monitoring software

► page 68



## ► Dimensions (in mm)

MEMO3-M

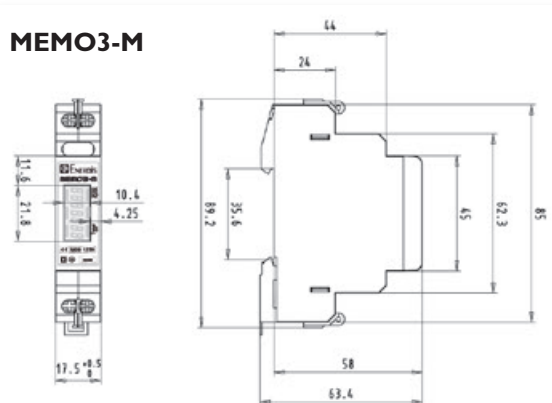

MEMO3

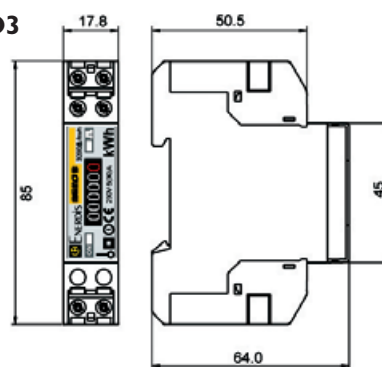

## ► Electrical connections

MEMO3-M



MEMO3



### TO ORDER

Model	Reference
MEMO3	MEMN 003NA
MEMO3-M	P01330700
Terminal covers (x10)	P01330701





# MEMO 4 single-phase 45 A

Energy meter for single-phase networks  
45 A direct connection

Energy meters  
Energy performance

**PRODUCT ADVANTAGES**

- + INTEGRATED RS485 Modbus COMMUNICATION
- + Resettable PARTIAL METERING INDEX
- + TWO-WAY METERING
- + DOUBLE-TARIFF metering
- + Adjustable PULSE WEIGHT
- + MULTI-MEASUREMENT DISPLAY of up to 15 quantities
- + MID Class B

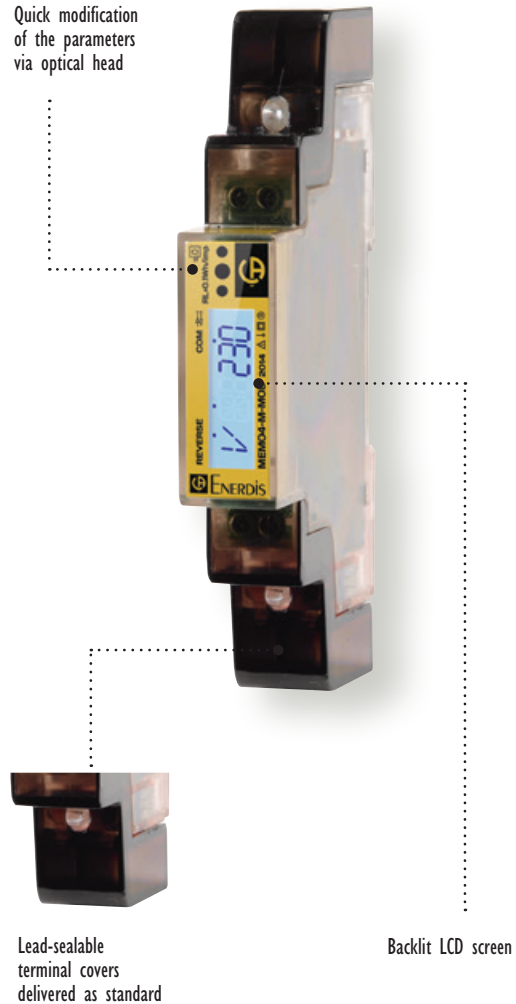

## ► Description

**MEMO 4** is a versatile range of **single-phase meters for low-voltage networks**. These meters are ideal for **metering** and **submetering** in all sectors of activity (tertiary, industry, data centers, vehicle recharging stations, etc.) and can monitor **energy consumption for electricity rebilling on private networks (MID version)**.

- Distribution of active and reactive power
- 1 pulse output as standard (adjustable weight)
- MID version for energy rebilling on private networks (MEMO 4-M and MEMO 4-M Modbus)
- Tariff change via communication system (MEMO 4 Modbus and MEMO 4-M Modbus)
- Multiple measurements:
  - Instantaneous quantities: V, I, PF and F
  - Instantaneous quantities and energy index according to the direction of the energy and the tariff: P, Q and S
- RS485 Modbus communication output (MEMO 4 Modbus and MEMO 4-M Modbus)
- Two-way energy metering (consumed and generated)
- Resettable partial active energy index

If you use your MEMO 4 with a remote data-retrieval solution and the **E.online** energy management software, you can recover your energy consumption data remotely on your PC so that you can automatically generate consumption reports and allocate consumption fairly.

## ► Electrical specifications

Current input	
Rated current (I <sub>max</sub> )	45 A
Min. current (I <sub>min</sub> )	250 mA
I <sub>start</sub> current (I <sub>st</sub> )	20 mA
Voltage input	
Rated voltage (U <sub>n</sub> )	230 Vac (-15% / + 10%)
Consumption	≤ 2 W
Frequency	50 Hz (±10%)
Metrological LED	
Weight	10,000 pulses/kWh
Pulse output	
Weight	Programmable (0.01 - 0.1 - 1 - 10 - 100 - 1,000 - 2,000 - 10,000 pulses/kWh)
Accuracy	
Active energy	Class 1 according to IEC 62053-21 MID class B according EN 50470-1-3
Infrared output	
Wave length IR	900 - 1,000 nm
Protocol	IEC 62056-21/2002 (IEC 1107)
Communication	
Bus type	RS485
Protocol	MODBUS RTU with 16 bit CRC
Transmission speed	1,200 - 2,400 - 4,800 - 9,600 bauds/s (by default)
Address	0 - 247 (by default 2 last digits of SN)
Bus maximum loads	60
Maximum distance	1,000 m

## ► Mechanical specifications

Protection rating	IP 51 on front panel
Power circuit connection	Max 10 mm <sup>2</sup>
Pulse output connection or communication	Max 2.5 mm <sup>2</sup>
Mounting	On 35 mm DIN rail
Weight	80 g

## ► Environment

Operating temperature	-25 °C to +55 °C
Relative humidity	≤ 75 %

## ► Dimensions (in mm)

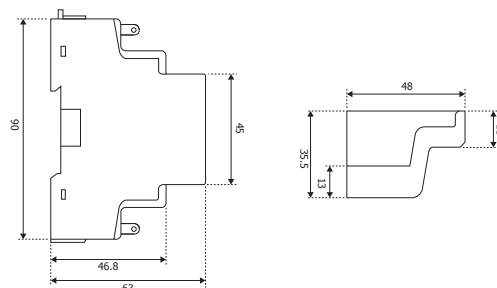

## ► Electrical connections

### MEMO4-M

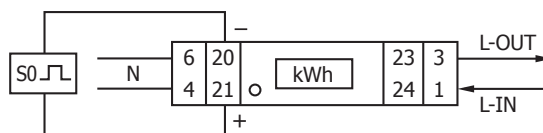

### MEMO4 Modbus / MEMO4-M Modbus

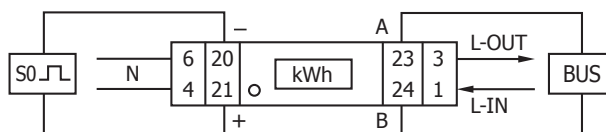

## ► Diagram

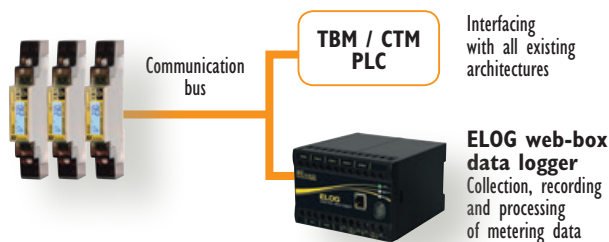

## T O O R D E R

Model	Certification	Communication	Reference
MEMO 4-M	MID	-	P01330751
MEMO 4 Modbus	IEC	RS485 Modbus	P01330752
MEMO 4-M Modbus	MID	RS485 Modbus	P01330753

Accessories	Reference
MEMO 4 optical head	P01330790

To facilitate quick programming of your MEMO 4 meters, an adapter is supplied with the optical head.

## ► Associated products

Data retrieval solutions

► page 56



E.online monitoring software

► page 68





# ULYS MD65 single-phase 65 A

Energy meter for single-phase networks  
65 A direct connection

Energy meters  
Energy performance

## PRODUCT ADVANTAGES

- + FULL COMPLIANCE WITH IEC 62053-21 STANDARD – Class 1
- + MID VERSION for rebilling Class B
- + COMPACT: only 2 DIN modules
- + PULSE OUTPUT
- + LCD SCREEN



Display of energy index on a LCD screen



Sealable terminal cover



Direct connection up to 65 A

## Description

**ULYS MD65** is an active energy meter for use in single-phase networks. This meter is designed for energy management applications on medium-power single-phase networks.

In particular, it is ideal for 63/65 A feeders in installations such as Buildings/Offices/Data centres/Shopping centres/Airports.

- Active energy metering for single-phase networks
- 1 pulse output can be connected to a data logger
- 65 A direct current inputs
- Display of the energy
- MID version available on request for rebilling



## ► Electrical specifications

Current input	
Type	single phase
Rated current	65 A
Istart current	40 mA
Max. permanent current	0.5 A
Voltage input	
Measurement range	0 to 999,999.9 kWh
Consumption	> 8 VA
Rated voltage	230 V (-20% / +15%)
Frequency	50 Hz / 60 Hz
Pulse output	
Type	Insulated 5,000 VAC
Duration	Ton ≥ 85 ms / Toff ≥ 155 ms
Weight	1,000 pulses / kWh
Max voltage	350 Vdc/ac
Max current	130 mA
Accuracy	
Active energy	Class 1 as per IEC 62053-21 Class B according to EN 50470-3 (MID)
Metrological LED	
Characteristics	flashing red — 1,000 times / kWh

## ► Mechanical specifications

Protection rating	IP51
Power circuit connection	Screw connection terminal for 16 mm <sup>2</sup> wires
Pulse output connection	Screw connection terminal for 0.28 mm <sup>2</sup> wires (single strand)
Mounting	On DIN rail 35 mm
Weight	120 g

## ► Environment

Operating temperature	-25°C to +60°C
Storage temperature	-40°C to +70°C
Relative humidity	75% average at 23°C ie 95% during 30 days at 23°C

## ► Dimensions (in mm)

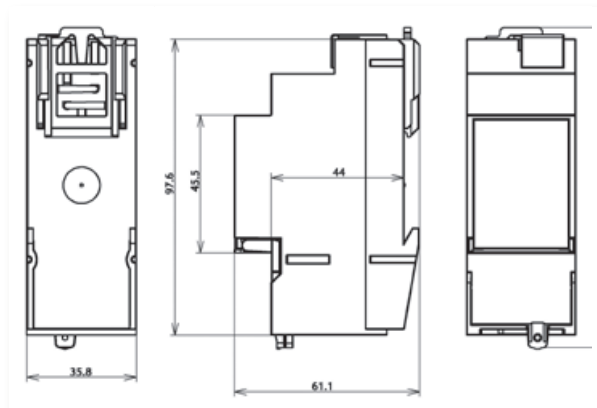

## ► Electrical connections

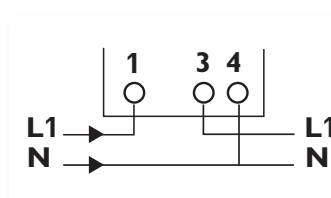

## ► Pulse output

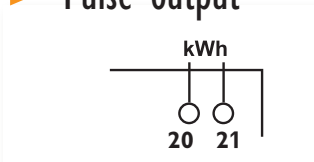

## ► Screen elements

Display	LCD screen
Digit height	5 mm
Numbers	7 digits from 000,000.0 to 999,999.9

### TO ORDER

Model	Certification	Reference
ULYS MD65	IEC	P01330920
ULYS MD65-M	MID	P01330921

## ► Associated products

Data retrieval solutions

► page 56



E.online monitoring software

► page 68





# ULYS MD80 single-phase 80 A

Energy meter for single-phase networks  
80 A direct connection

Energy meters  
Energy performance

**PRODUCT ADVANTAGES**

- + IEC Class 1  
MID CLASS B
- + 4 QUADRANTS
- + MULTI-MEASUREMENTS
- + COMPATIBLE WITH ULYSCOM multi-communication protocols
- + COMPACT: only 2 DIN modules



2 tariffs



4 quadrants metering with energy balance indicator



2 pulses outputs as standard assignable to P, Q, S

## ► Description

- ULYS MD80** is an energy meter for use in single-phase networks. This meter is designed for energy management applications or rebilling (MID version). It is ideal for 80 A feeders in installations such as Building/Offices/Shopping centres.
- 2 pulse outputs as standard features assignable to P, Q or S
  - 80 A direct current inputs
  - Indication of connection errors
  - MID version available for rebilling
  - Tariff-change input as a standard feature (2 tariffs)
  - Compatible with ULYSCOM communication modules (RS485, M-Bus, Ethernet)
  - Automatic detection modules via the infrared port on the side of the product
  - Multi-measurement: instantaneous P, Q and S, cumulative and partial energy index (V, I, PF, F via ULYSCOM)
  - Sealable covers (delivered with lead for MID version)

## ► Electrical specifications

Current input	
Type	direct
Rated current	(5) 80 A
Istart current	20 mA
Voltage input	
Rated voltage	230...240 Vac ( $\pm 20\%$ )
Input consumption	7.5 VA max. per phase
Measurement range	0 to 9,999,999.9 kWh
Frequency	50/60 Hz
Tariff change input	
T1	No voltage
T2	from 80 Vac/Vdc to 276 Vac/Vdc max.
Pulse output	
Type	Optically isolated 250 Vac/dc
Number	2 assignable to Ea, Eq, or Es
Pulse weight	500 pulses/kWh, /kVAh, /kVAh
Pulse duration	50 ms
Max current	100 mA
Metering (accuracy)	
Active energy	Class 1 according to IEC 62053-21 MID Class B according to EN 50470-1-3
Reactive energy	Class 2 according to IEC 62053-23
Metrological LED	
(Weight)	1,000 pulses/kWh

## ► Mechanical specifications

Format	2 DIN modules
Mounting	On DIN rail
Connection	Screw-on terminal strip for 35 mm <sup>2</sup> wire
Protection	IP51 front panel

## ► Environment

Operating temperature	-25°C to +55°C
Storage temperature	-25°C to +75°C
Relative humidity	Max 80% without condensation

### TO ORDER

Model	Certification	Reference
ULYS MD80	IEC	P01331010
ULYS MD8-M	MID	P01331011

## ► Associated products

ULYSKOM  
Communication modules

► page 36



E.online monitoring  
software

► page 68



Data retrieval  
solutions

► page 56



## ► Dimensions (in mm)

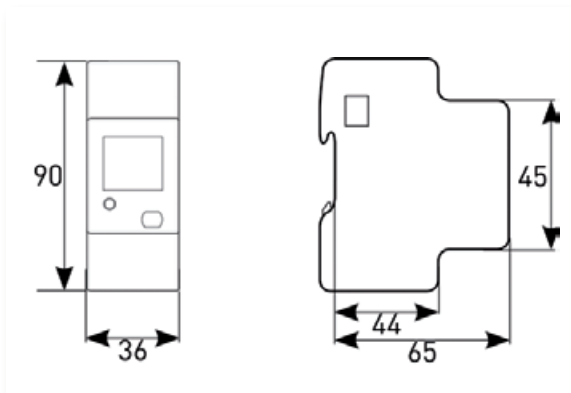

## ► Electrical connections

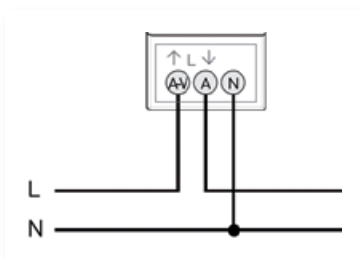

Tariff inputs & S0 pulse outputs

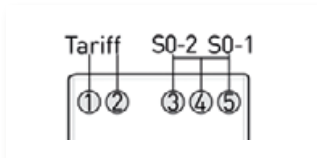

## ► Infrared connection

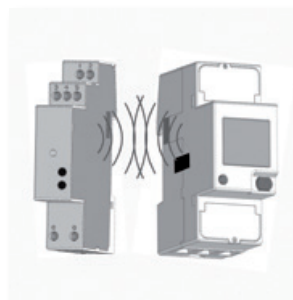



# ULYS TD80 three-phase 80 A with integrated communication

Energy meter for three-phase networks  
Direct connection up to 80 A

Energy meters  
Energy performance

**PRODUCT ADVANTAGES**

- + INTEGRATED COMMUNICATION**  
depending on model:  
Ethernet, M-Bus, Modbus
- + IEC Class 1 MID CLASS B**
- + 4 QUADRANTS**
- + MULTIPLE MEASUREMENTS**
- + COMPACT: only 4 DIN modules**

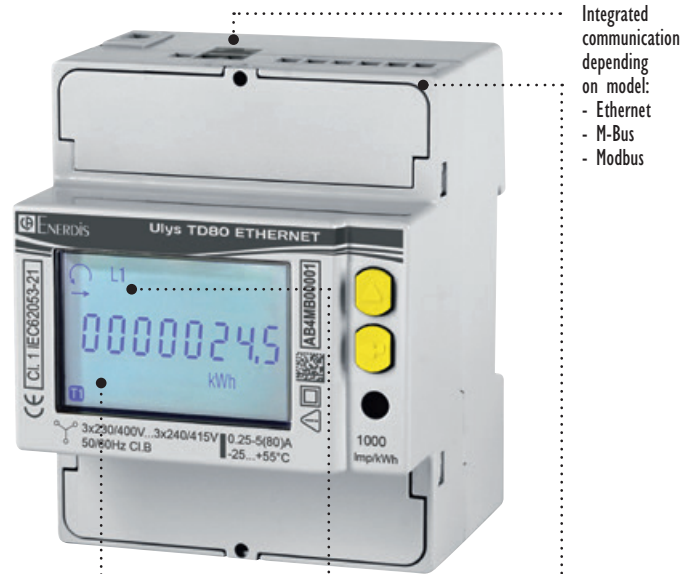

Integrated communication depending on model:  
- Ethernet  
- M-Bus  
- Modbus

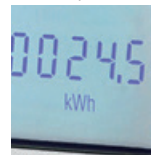

Customizable display of up to 15 electrical quantities



Measurement in all 4 quadrants with energy balance indicator



1 pulse output as standard, configurable as P, Q or S

## ► Description

The **ULYSTD80** is an energy meter designed for use on three-phase networks. It is an ideal solution for energy management applications or for electricity rebilling on private networks (MID version). It is particularly suitable for 80 A applications in buildings, shopping malls, etc.

- Integrated communication depending on model: Ethernet, M-bus or Modbus
- Small size (4 modules)
- Display customizable by means of predefined user profiles
- 1 pulse output as standard, configurable as P, Q or S
- Direct inputs for current up to 80 A
- Connection error indicator
- MID version available for electricity rebilling
- Tariff-change input as standard (double tariff) except on Ethernet model
- Direct display of multiple measurements: instantaneous P, Q and S, total and partial energy indices, V, U, I, PF, F
- Lead-sealable terminal covers (delivered with lead for MID version)

## ► Electrical specifications

Current input	
Type	Direct
Rated current (In)	(5) 80 A
Istart current (Ist)	20 mA
Voltage input	
Rated voltage (Un)	3 x 230/400 Vac... 3 x 240/415 Vac (±20%)
Consumption	7.5 VA max. per phase
Frequency	50/60 Hz
Tariff change input (M-bus and Modbus models)	
T1	No voltage
T2	from 80 Vac/Vdc to 276 Vac/Vdc max.
Pulse output	
Type	Optically isolated 250 Vac/dc
Number	1 assignable to Ea, Eq, or Es
Weight	100 pulses/kWh, /kVAh, /kVAh
Accuracy	
Active energy	Class 1 according to IEC 62053-21 MID class B according EN 50470-1-3
Reactive energy	Class 2 according to IEC 62053-23
Metrological LED	
Weight	1,000 pulses/kWh
Communication	
Ethernet	IEEE 802.3 standard Modbus TCP, HTTP, NTP and DHCP protocols Integrated web pages
Modbus	EIA RS485 standard RS485 bus Modbus RTU / ASCII protocol Speed: 300... 57,600 bauds
M-bus	IEC 13757-1-2-3 standard M-bus protocol Speed: 300... 9,600 bauds

## ► Mechanical specifications

Format	4 DIN modules
Mounting	On DIN rail
Connection	Screw-on terminal strip for 35 mm <sup>2</sup> wire
Protection	IP51 front panel

## ► Environment

Operating temperature	-25°C to +55°C
Storage temperature	-25°C to +75°C
Relative humidity	Max 80% without condensation

## ► Associated products

Data retrieval solutions

► page 56



E.online monitoring software

► page 68



## ► Dimensions (in mm)

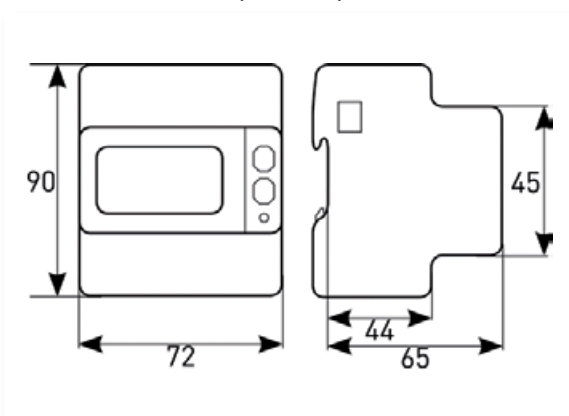

## ► Electrical connections

4 wires, 3 currents  
All models

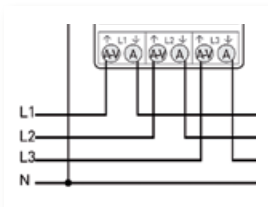

3 wires, 3 currents  
M-bus model

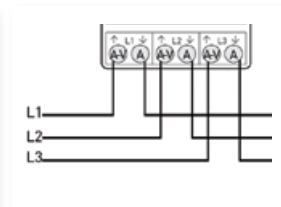

3 wires, 2 currents  
M-bus model

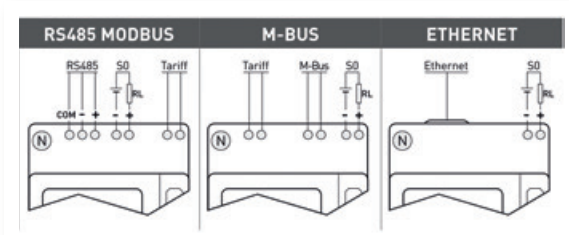
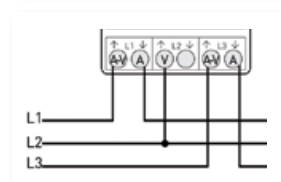

## T O O R D E R

Model	Certification	Reference
ULYS TD80 Modbus	IEC	P01331034
ULYS TD80-M Modbus	MID	P01331036
ULYS TD80 M-bus	IEC	P01331042
ULYS TD80-M M-bus	MID	P01331044
ULYS TD80 Ethernet	IEC	P01331038
ULYS TD80-M Ethernet	MID	P01331040



# ULYS TT three-phase CT connection with integrated communication

Energy meter for three-phase networks  
Connection on CT

Energy meters  
Energy performance

**PRODUCT ADVANTAGES**

- + INTEGRATED COMMUNICATION**  
depending on model:  
Ethernet, M-Bus, Modbus
- + IEC Class 1 MID CLASS B**
- + 4 QUADRANTS**
- + MULTIPLE MEASUREMENTS**
- + COMPACT: only 4 DIN modules**

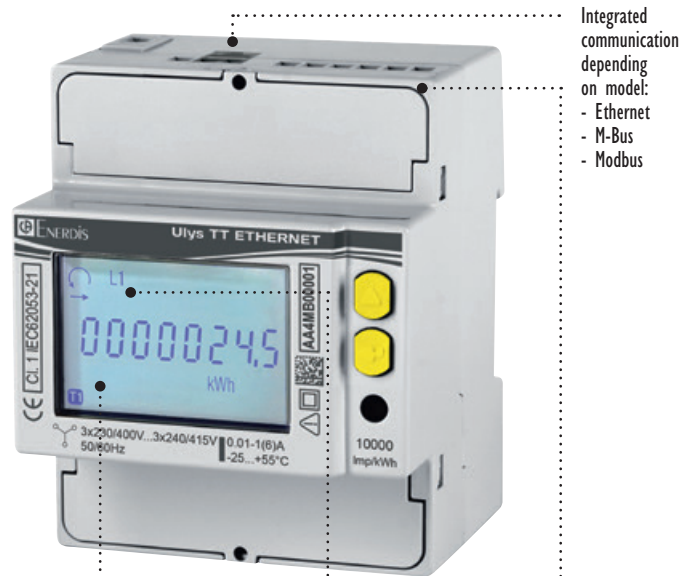

Integrated communication depending on model:  
- Ethernet  
- M-Bus  
- Modbus



Customizable display of up to 15 electrical quantities



Measurement in all 4 quadrants with energy balance indicator



1 pulse output as standard, configurable as P, Q or S

## Description

The **ULYSTT** is an energy meter designed for use on three-phase networks. It is an ideal solution for energy management applications or for electricity rebilling on private networks (MID version).

- Integrated communication depending on model: Ethernet, M-bus or Modbus
- Small size (4 modules)
- Display customizable by means of predefined user profiles
- 1 pulse output as standard, configurable as P, Q or S
- 1 or 5 A isolated inputs
- Connection error indicator
- MID version available for electricity rebilling
- Tariff-change input as standard (double tariff) except on Ethernet model
- Direct display of multiple measurements: instantaneous P, Q and S, total and partial energy indices, V, U, I, PF, F
- Lead-sealable terminal covers (delivered with lead for MID version)



## ► Electrical specifications

Current input	
Type	On CT 1 or 5 A
Rated current (In)	5 A
Istart current (Ist)	20 mA
Voltage input	
Rated voltage (Un)	3 x 230/400 Vac... 3 x 240/415 Vac (±20%)
Consumption	7.5 VA max. per phase
Frequency	50/60 Hz
Tariff change input (M-bus and Modbus models)	
T1	No voltage
T2	from 80 Vac/Vdc to 276 Vac/Vdc max.
Pulse output	
Type	Optically isolated 250 Vac/dc
Number	1 assignable to Ea, Eq, or Es
Weight	100 pulses/kWh, /kVAh, /kVAh
Accuracy	
Active energy	Class 1 according to IEC 62053-21 MID class B according EN 50470-1-3
Reactive energy	Class 2 according to IEC 62053-23
Metrological LED	
Weight	1,000 pulses/kWh
Communication	
Ethernet	IEEE 802.3 standard Modbus TCP, HTTP, NTP and DHCP protocols Integrated web pages
Modbus	EIA RS485 standard RS485 bus Modbus RTU / ASCII protocol Speed: 300... 57,600 bauds
M-bus	IEC 13757-1-2-3 standard M-bus protocol Speed: 300... 9,600 bauds

## ► Mechanical specifications

Format	4 DIN modules
Mounting	On DIN rail
Connection	Screw-on terminal strip for 35 mm <sup>2</sup> wire
Protection	IP51 front panel

## ► Environment

Operating temperature	-25°C to +55°C
Storage temperature	-25°C to +75°C
Relative humidity	Max 80% without condensation

## ► Associated products

Data retrieval solutions

► page 56



E.online monitoring software

► page 68



## ► Dimensions (in mm)

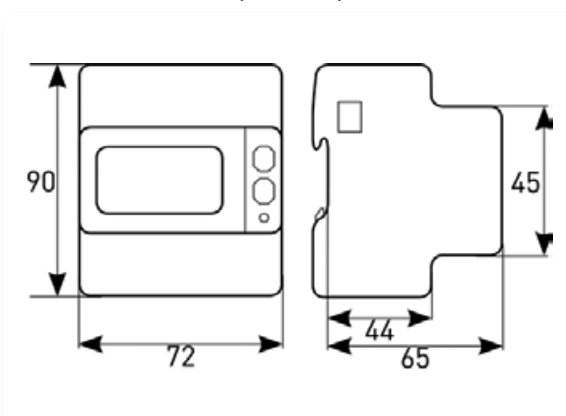

## ► Electrical connections

4 wires, 3 currents  
All models

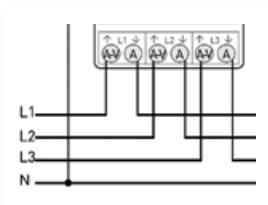

3 wires, 3 currents  
M-bus model

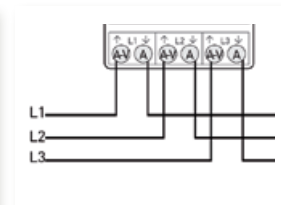

3 wires, 2 currents  
M-bus model

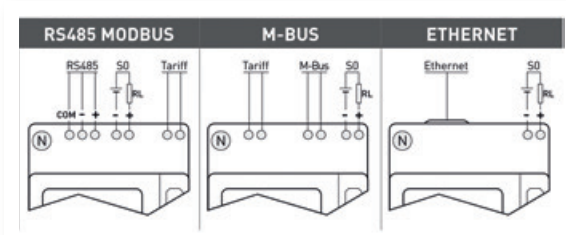
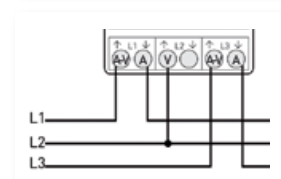

## TO ORDER

Model	Certification	Reference
ULYS TT Modbus	IEC	P01331035
ULYS TT-M Modbus	MID	P01331037
ULYS TT M-bus	IEC	P01331043
ULYS TT-M M-bus	MID	P01331045
ULYS TT Ethernet	IEC	P01331039
ULYS TT-M Ethernet	MID	P01331041





# ULYS TDA80 three-phase 80 A

Energy meter for three-phase LV networks  
80 A direct connection

Energy meters  
Energy performance

## PRODUCT ADVANTAGES

- + IEC Class 1  
MID CLASS B
- + 4 QUADRANTS
- + MULTI-MEASUREMENTS
- + COMPACT: only  
4 DIN modules
- + COMPATIBLE WITH  
ULYSCOM  
multi-communication  
protocols



2 tariffs



4 quadrants metering  
with energy balance  
indicator



2 pulses outputs as  
standard assignable  
to P, Q, S

## Description

- ULYS TDA80** is an energy meter for use in three-phase networks. This meter is designed for energy management applications or rebilling (MID version). It is ideal for 80 A feeders in installations such as Building/Offices/Shopping centres
- 2 pulse outputs as standard features assignable to P, Q or S
  - 80 A direct current inputs
  - Indication of connection errors
  - MID version available for rebilling
  - Tariff-change input as a standard feature (2 tariffs)
  - Compatible with ULYSCOM communication modules (RS485, M-bus, Ethernet)
  - Automatic detection modules via the infrared port on the side of the product
  - Multi-measurement: instantaneous P, Q and S, cumulative and partial energy index (V, U, I, PF, F via ULYSCOM)
  - Sealable covers (delivered with lead for MID version)

## ► Electrical specifications

Current input	
Type	direct
Rated current	(5) 80 A
Istart current	20 mA
Voltage input	
Rated voltage	3 x 230/400 Vac... 3 x 240/415 Vac (± 20%)
Input consumption	7.5 VA max. per phase
Measurement range	0 to 9,999,999.9 kWh
Frequency	50/60 Hz
Tariff change input	
T1	No voltage
T2	80 Vac/dc to 276 Vac/dc max.
Pulse output	
Type	Optically isolated 250 Vac/dc
Number	2 assignable to Ea, Eq, or Es
Pulse weight	100 pulses/kWh, /kVAh, /kVAh
Pulse duration	50 ms
Max current	100 mA
Metering (accuracy)	
Active energy	Class 1 according to IEC 62053-21 MID Class B according to EN 50470-1-3
Reactive energy	Class 2 according to IEC 62053-23
Metrological LED	
(Weight)	1,000 pulses/kWh

## ► Mechanical specifications

Format	4 DIN modules
Mounting	On DIN rail
Connection	Screw-on terminal strip for 35 mm <sup>2</sup> wire
Protection	IP51 front panel

## ► Environment

Operating temperature	-25°C to +55°C
Storage temperature	-25°C to +75°C
Relative humidity	Max 80% without condensation

### TO ORDER

Model	Certification	Reference
ULYS TDA	IEC	P01331012
ULYS TDA80-M	MID	P01331018

## ► Associated products

ULYSKOM  
Communication modules

► page 36



E.online monitoring  
software

► page 68



Data retrieval  
solutions

► page 56



## ► Dimensions (in mm)

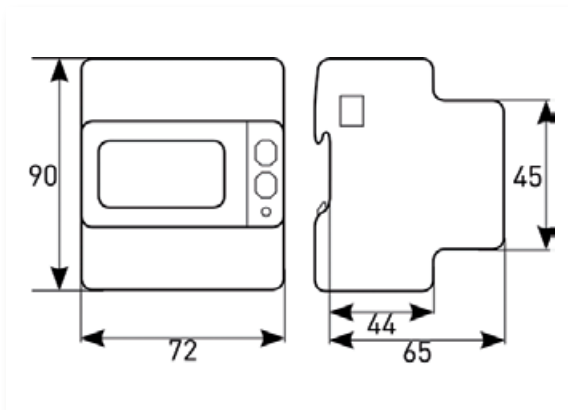

## ► Electrical connections

4 wires, 2 currents

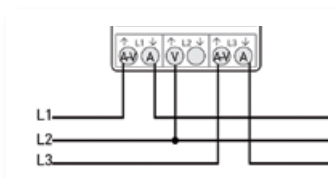

3 wires, 3 currents

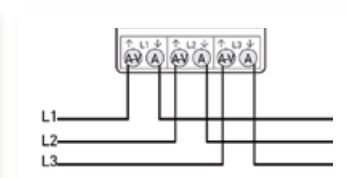

4 wires, 3 currents

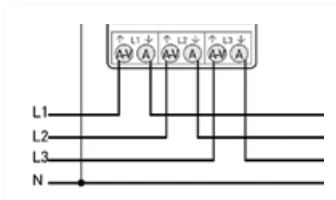

Tariff inputs & S0 pulse outputs

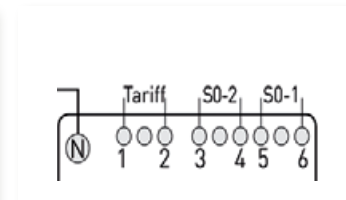

## ► Infrared connection

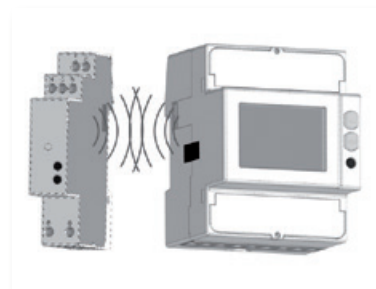



# ULYS TTA three-phase CT connection

Energy meter for three-phase LV networks  
CT connection

Energy meters  
Energy performance

**PRODUCT ADVANTAGES**

- + IEC Class 1  
MID CLASS B
- + MULTI-MEASUREMENTS
- + COMPATIBLE WITH ULYSCOM multi-communication protocols
- + COMPACT: only 4 DIN modules



2 tariffs



4 quadrants metering with energy balance indicator



2 pulses outputs as standard assignable to P, Q, S

## ► Description

- ULYS TTA** is an energy meter for use in three-phase networks. This meter is designed for energy management applications or rebilling (MID version).
- 2 pulse outputs as standard features assignable to P, Q or S
  - 1 or 5 A isolated inputs
  - Indication of connection errors
  - MID version available for rebilling
  - Tariff-change input as a standard feature (2 tariffs)
  - Compatible with ULYSCOM communication modules (RS485, M-bus, Ethernet)
  - Automatic detection modules via the infrared port on the side of the product
  - Multi-measurement: instantaneous P, Q and S, cumulative and partial energy index (V, U, I, PF, F via ULYSCOM)
  - Sealable covers (delivered with lead for MID version)

## ► Electrical specifications

Current input	
Type	On CT 1 or 5 A
Rated current	5 A
Istart current	20 mA
Voltage input	
Rated voltage	3 x 230/400 Vac... 3 x 240/415 Vac (± 20%)
Input consumption	7.5 VA max. per phase
Measurement range	0 to 9,999,999.9 kWh
Frequency	50/60 Hz
Tariff change input	
T1	No voltage
T2	80 Vac/dc to 276 Vac/dc max.
Pulse output	
Type	Optically isolated 250 Vac/dc
Number	2 assignable to Ea, Eq, or Es
Pulse weight	set automatically according to CT ratio: from 1,000 pulses/kWh to 0.1 pulses, kWh
Pulse duration	50 ms
Max current	100 mA
Metering (accuracy)	
Active energy	Class 1 according to IEC 62053-21 MID Class B according to EN 50470-1-3
Reactive energy	Class 2 according to IEC 62053-23
Metrological led	
(Weight)	1,000 pulses/kWh

## ► Mechanical specifications

Format	4 DIN modules
Mounting	On DIN rail
Connection	Screw-on terminal strip for 6 mm <sup>2</sup> wire
Protection	IP51 front panel

## ► Environment

Operating temperature	-25°C to +55°C
Storage temperature	-25°C to +75°C
Relative humidity	Max 80% without condensation

### TO ORDER

Model	Certification	Reference
ULYS TTA	IEC	P01331015
ULYS TTA-M	MID	P01331019

## ► Associated products

ULYSKOM  
Communication modules

► page 36



E.online monitoring  
software

► page 68



Data retrieval  
solutions

► page 56



## ► Dimensions (in mm)

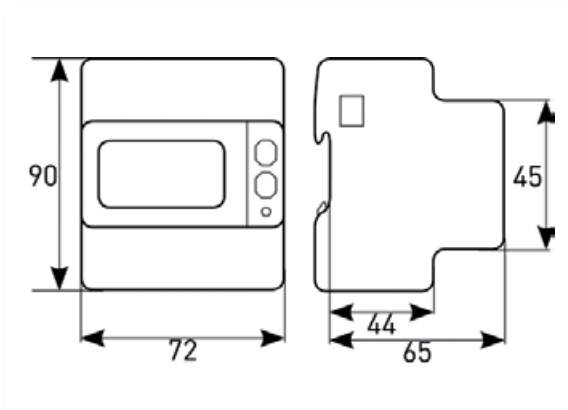

## ► Electrical connections

3 wires, 3 CTs

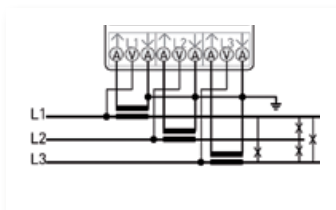

3 wires, 2 CTs

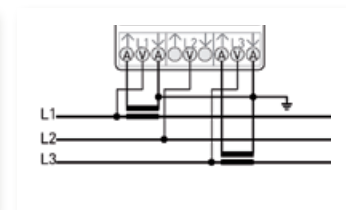

4 wires, 3 CTs

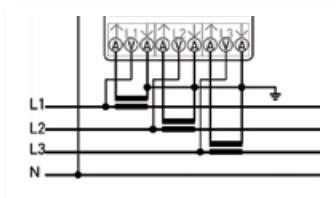

Tariff inputs & S0 pulse outputs

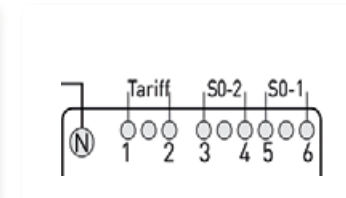

## ► Infrared connection

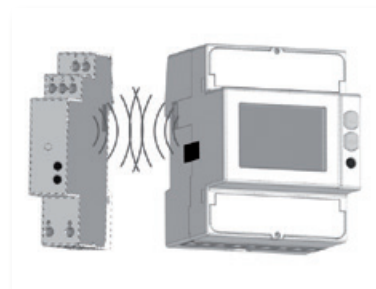



# ULYSCOM

Communication modules for ULYS MD80 – TDA80 - TTA energy meters

Energy meters  
Energy performance

**PRODUCT ADVANTAGES**

- + MULTI-PROTOCOL** communication modules: **ETHERNET, RS485, M-BUS**
- + AUTOMATIC RECOGNITION** of the modules by the associated meters
- + DIRECT INTERFACING:** between the metering point and Enerdis's energy management software or any other system



Communication activity status indicator LED



No-connection infrared link automatic detection between meter and ULYSCOM



Line termination resistance integrated directly in the RS485 module

## ► Description

**ULYSCOM** communication modules are suitable for single-phase or three-phase meters (ULYS MD80 – TDA – TTA range).

**ULYSCOM** modules allow direct interfacing between the metering point and Enerdis's energy management software or any other system (e.g. programmable logic controllers).

**ULYSCOM** modules gives access to all electrical quantities measured by the meter, as well as additional quantities such as V, U, I, PF and F.



## ► Specifications

### ULYSCOM RS485

Enables the meters to be interfaced directly with the Enerdis energy management software E.online® or with a CTM / TBM programmable logic controller.

- 230 Vac +/- 20 % / 50 Hz / < 5 VA
- Configurable RTU (8N1) or ASCII (7E2) mode
- Speed from 300 to 115,200 bps
- Integrated 120 Ω line termination resistance (directly activatable on the module)
- Connection: 2 wires, half-duplex

### ULYSCOM M-BUS

Delivered with the free M-Bus MASTER software to configure and read the quantities measured by the energy meter.

- Self-powered on the communication bus
- Speed from 300 to 38,400 bps
- Connection: 2 wires, M-Bus

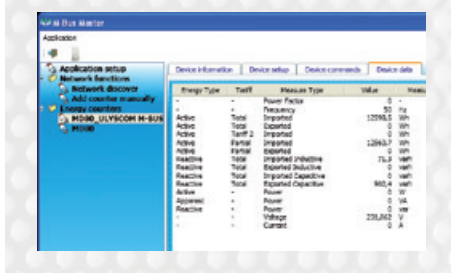

### ULYSCOM ETHERNET

Can be used to read measurements directly via integrated web pages and to view an overview of consumption covering several weeks with a simple web browser.

Direct measurement readings via integrated web pages.

- 230 Vac +/- 20 % / 50 Hz / < 5 VA
- Compatible with 10 or 100 base T
- Connection: RJ45

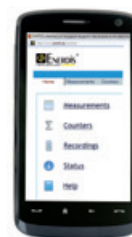

## ► Environment

Operating temperature	-25°C to +55°C (-15°C to +60°C for ULYSCOM KNX)
Storage temperature	-25°C to +75°C
Relative humidity	Max. 80% without condensation

### TO ORDER

Communication modules	Reference
ULYSCOM MODBUS RS485	P01331030
ULYSCOM M-BUS	P01331031
ULYSCOM ETHERNET MODBUS TCP	P01331032

## ► Mechanical specifications

Format	ULYSCOM RS485, M-Bus and KNX: 1 DIN module ULYSCOM Ethernet: 2 DIN modules
Mounting	On DIN rail
Connection	Screw-on terminal strip for 6 mm <sup>2</sup> wire
Protection	IP51 face avant

## ► Associated products

ULYS MD80  
Single-phase meter  
80 A direct input

► page 26



ULYS TDA80  
Three-phase meter  
80 A direct input

► page 32



ULYS TTA  
Three-phase meter  
CT connection

► page 34





# ENERIUM Range

Power monitors for all electrical networks compliant with the IEC 61557-12 standard

Energy performance **Power monitors**

**PRODUCT ADVANTAGES**

- + 8 LOAD CURVES**
- + 16 PROGRAMMABLE ALARMS**
- + GRAPHICS FOR easier data analysis**
- + SPECTRAL ANALYSIS** per phase up to the 50th order on U, I and In
- + QUALIMETRY** according to **EN50160 STANDARD**



Optical head for:  
- programming  
- reading the data  
- upgrading the firmware



Ethernet output (Modbus/TCP)  
RS485 output (Modbus/Jbus RTU)



Screenless version for DIN-rail mounting or plate mounting



Up to 8 on-off or analogue inputs/outputs

## Description

A complete range of 6 power monitors ideal for:

- LV/MV/HV network supervision
- installation sizing
- energy management
- electrical network quality applications

## Screen displays



**Display**  
Real-time display of instantaneous, average...  
Time/date-stamped recording of min and max values



**16 alarms**  
Programmable, viewing of alarms log, recording of the last 64 events



**Recording**  
Indices and consumption curves (electricity, water, gas).  
Temperature curves and trend curves



**Customizable screens**  
3 screens with 4 display lines each to organize the information as you wish



**Qualimetry**  
Measurement of THD per phase on U, I and In.  
Spectral analysis per phase up to the 50th order on U, I and In



**Quick programming**  
Current transformer ratios and communication parameters can be set on the front panel or remotely



**Graphics**  
For easier data analysis. Fresnel diagram. Gauge for V, U, I, P



**Indication of connection errors**





**Qualimetry**  
Log of the last 1024 events (dips, outages, overvoltages, overcurrents).  
Waveform capture (V-U-I-In)  
Statistical analysis graphs as per EN50160



**Preventive maintenance**  
Installation operating time. Operating time of monitored equipment



## ► Functional specification

Power monitor						
Flush-mounting 96 x 96			Flush-mounting 144 x 144			
ELECTRICAL ENERGY			MULTI-ENERGY		POWER QUALITY	
						
Enerium 30    Enerium 50    Enerium 150			Enerium 100    Enerium 200		Enerium 300	
Functional specifications						
Accuracy class (IEC61557-12)	1	0.5	0.5	0.5	0.5 or 0.2	0.2
Format	96 x 96 mm	96 x 96 mm	96 x 96 mm	144 x 144 mm	144 x 144 mm	144 x 144 mm
Graphic LCD screen	✓	✓	✓	✓	✓	✓
Version without display	-	-	-	Enerium 110	Enerium 210	Enerium 310
Mounting	Flush-mounted, DIN rail* or plate-mounted*	Flush-mounted, DIN rail* or plate-mounted*	Flush-mounted, DIN rail* or plate-mounted*	Flush-mounted, DIN rail* or plate-mounted (Enerium 110)	Flush-mounted, DIN rail* or plate-mounted (Enerium 210)	Flush-mounted, DIN rail* or plate-mounted (Enerium 310)
Harmonics						
Max. order	-	25	50	25	50	50
Recording functions						
8 load curves	-	✓	✓	-	✓	✓
4 trend curves	-	-	✓	✓	✓	✓
Alarms						
Number of alarms	2	16	16	16	16	16
Time/date-stamped events recorded	-	64	64	64	64	64
Qualimetry functions						
Qualimetry according to EN50160	-	-	-	-	-	✓
V, U, I and In waveform capture	-	-	-	-	-	16
Storage of last 1024 events (dips, outages, overvoltages) with time/date-stamping	-	-	-	-	-	✓
Inputs / outputs						
Max. number	1	2	2	8	8	8
Inputs (optional)						
On-off (pulses or alarm)	-	0, 1 or 2	0, 1 or 2	0, 2, 4, 6 or 8	0, 2, 4, 6 or 8	0, 2, 4, 6 or 8
Analogue	-	-	-			
Outputs (optional)						
On-off (pulses or alarm)	0 or 1	0, 1 or 2	0, 1 or 2	0, 2, 4, 6 or 8	0, 2, 4, 6 or 8	0, 2, 4, 6 or 8
Analogue	0	0 or 2	0 or 2	0, 2 or 4	0, 2 or 4	0, 2 or 4
Graphics						
Fresnel	-	-	✓	✓	✓	✓
Gauges	✓	-	✓	-	-	-
Histograms of harmonic orders	-	-	✓	-	✓	✓
Communication interface						
Optical / USB	-	Front	Front	Front or rear	Front or rear	Front or rear
Ethernet or RS485	RS485	✓	✓	✓	✓	✓
Metrological LED	-	-	-	✓	✓	✓
Other functions						
Programming on front panel	✓	✓	✓	✓	✓	✓
Programming via software	-	✓	✓	✓	✓	✓

\* With mounting kit



# ENERIUM Range

Power monitors  
Energy performance

## ▶ Example of applications

### ANALOGUE INPUTS

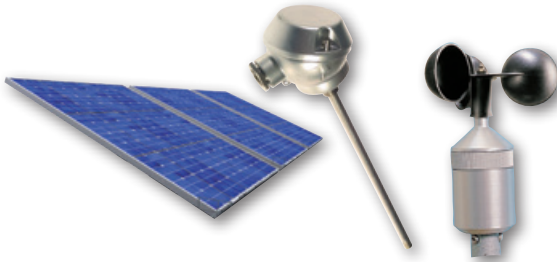

### METERING INPUTS



insolation, weather data, temperatures, etc.

water, gas, electricity

### CURRENT AND VOLTAGE INPUTS - LV/MV/HV NETWORKS

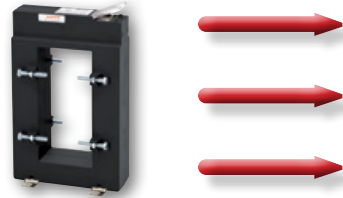

### ANALOGUE OUTPUTS



### ALARM RELAY OUTPUTS

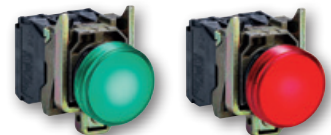

**SYNCHRO PULSE INPUTS**

**STORAGE OF STATUSES AND ALARMS**

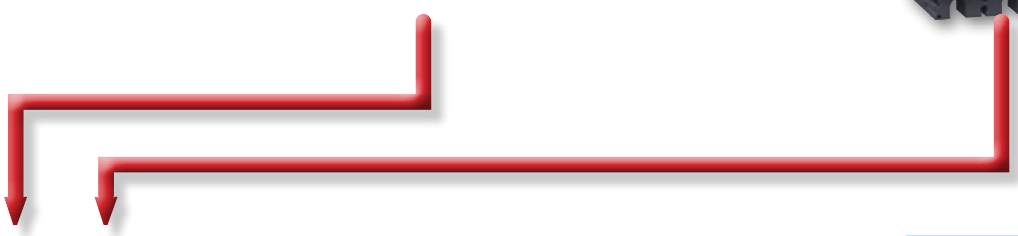

**E.ONLINE® ENERGY  
MANAGEMENT SOFTWARE**



**PLCs FOR CTM/TBM SUPERVISION**

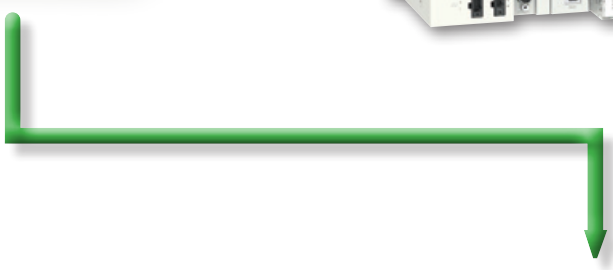

**PLC OUTPUTS (ALARM/PULSE)**



Legend for flow diagram:

- Inputs
- Communication
- Outputs

Photos: Chauvin-Arnoux - Schneider Electric.



### Measurements

	I S	min	max	average	min average	max average
V, U	●	○	●	●		○
Yearth	○	○	○	○		○
I	●	○	●	●		○
In (calculated or measured) <sup>(1)</sup>	●	○	●	●	○	○
P (4 quadrants)	●		○	○		
Pt (4 quadrants)	●	●	●	●		○
Q (4 quadrants)	●		○	○		
Qt (4 quadrants)	●	○	●	●		○
S	●		○	○		
St	●	●	●	●		○
FP (4 quadrants)	●			○		
FPt (4 quadrants)	●			●	○	○
Cosφ (4 quadrants)	○			○		
Cosφpt (4 quadrants)	○	○	○	○	○	○
Tanφ (4 quadrants)	●			●	○	○
Frequency	●	○	●	○		
V crest factor	○			○		○
I crest factor	○			○		○
U unbalance	○			○		○
Harmonics on V, U, I	○					
Harmonics on In	○					
THD V, U, I	●			●		○
THD In	●		○	●		○
Active energy (receiver, generator)	●					
Reactive energy (Qcad1, 2, 3, 4)	●					
Apparent energy (receiver, generator)	●					
On-off input (pulse mode)	○					
Analogue input (Enerium 100/200)	○	○	○	○	○	○
Voltage presence hour meter (U)	○					
Load hour meter (I)	●					
Auxiliary power supply hour meter	●					

○ Except on Enerium 30

<sup>(1)</sup> on Enerium 30/50/150, calculated only

### Connection diagrams

#### Single-phase

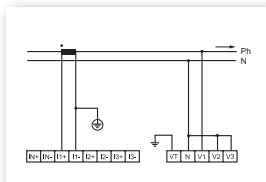

#### Balanced 3-phase, 4 wires - 1 CT Except on Enerium 30

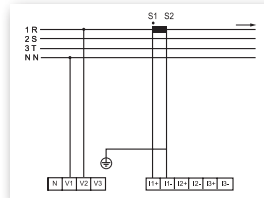

#### Balanced 3-phase, 4 wires - 1 CT Enerium 30 only

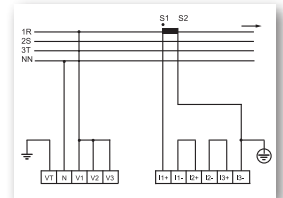

#### Balanced 3-phase, 3 wires - 1 CT Enerium 30 only

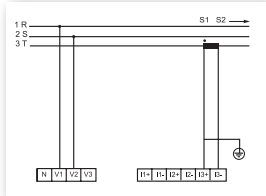

#### Unbalanced 3-phase, 4 wires - 3 CTs

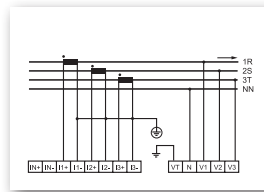

#### Unbalanced 3-phase, 4 wires - 4 CTs Except on Enerium 30/50/150

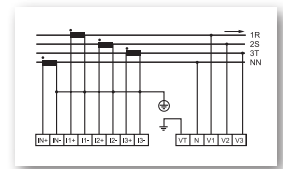

#### Unbalanced 3-phase, 3 wires - 3 CTs

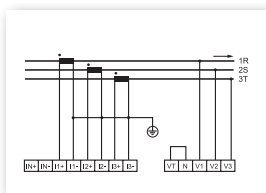

#### Unbalanced 3-phase, 3 wires - 2 CTs

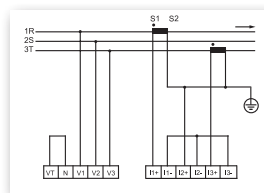

#### Example of connection to UT

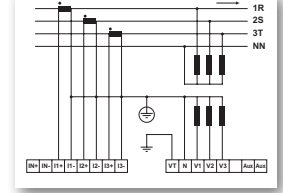

## ► Trend curves

(except on Enerium 30/50)

IS VALUES	
V, Vearth	•
U12, U23, U31	•
I1, I2, I3, In	•
Pt	•
Qt	•
St	•
PFt	•
U unbalance	•
THD V, U, I, In	•
Analogue inputs (Enerium 100/200 only)	•
AVERAGE VALUES	
V1, V2, V3	•
U12, U23, U31	•
I1, I2, I3, In	•
Gen: P1, P2, P3, Pt	•
Rec: P1, P2, P3, Pt	•
Analogue inputs (Enerium 100/200 only)	•
Gen: PF1, PF2, PF3, PFt	•
Rec: PF1, PF2, PF3, PFt	•
Gen: Cosφ1, Cosφ2, Cosφ3, Cosφt	•
Rec: Cosφ1, Cosφ2, Cosφ3, Cosφt	•
Tanφt	•
Frequency	•
Crest factor V1, V2, V3	•
Crest factor I1, I2, I3	•
THD U12, U23, U31	•
THD I1, I2, I3, Ineutral	•
THD V1, V2, V3	•

## ► Load curves

(except on Enerium 30/100 and 110)

AVERAGE VALUES	
Pt Gen, Pt, Rec	•
Qcad1, Qcad2, Qcad3, Qcad4,	•
St Gen, St Rec	•
On-off inputs	•
Analogue inputs (Enerium 200 only)	•

## ► Alarms

IS VALUES	
V1, V2, V3	•
Vearth	○
U12, U23, U31	•
I1, I2, I3, In	•
Pt	•
Qt	•
St	•
PFt	•
Cosφt	○
Tanφt	•
Frequency	•
U unbalance	○
THD V, U, I, In	○
3 hour meters: network presence, on-load presence, aux. source	○
Analogue inputs (Enerium 100/200 only)	○
AVERAGE VALUES	
Pt Gen, Pt Rec	○
Qt Gen, Qt Rec	○
St	○
Tanφt (except on Enerium 30/50/150)	○
Analogue inputs (Enerium 100/200 only)	○
ON-OFF INPUTS (Enerium 100/200/300 only)	
	•

○ Except Enerium 30

## ► Analogue outputs (option)

(Except Enerium 30)

IS VALUES	
V1, V2, V3, Vearth	•
U12, U23, U31	•
I1, I2, I3, In	•
Pt	•
Q1, Q2, Q3	•
Qt	•
S1, S2, S3	•
St	•
PF1, PF2, PF3	•
PFt	•
Cosφ1, Cosφ2, Cosφ3,	•
Cosφt,	•
Tanφt,	•
Frequency	•



## ► General specifications

	ENERIUM 30 Class I	ENERIUM 50/150 Class 0.5 s	ENERIUM 100/200 Class 0.5 s	ENERIUM 200 Class 0.2 s	ENERIUM 300 Class 0.2 s
<b>Electrical network</b>					
Max. phase-to-phase voltage measured	650 kV				
VT ratio	VT primary: 100 V to 650 kV VT secondary: 100 V to 480 V				
Max. current measured	25,000 A				
CT ratio	CT primary: 1 A to 25,000 A CT secondary: 1 A or 5 A				
Max. power measured	2 GW				
<b>Voltage inputs (AC)</b>					
Measurement range	5 to 130 % of Vn for Vn = 57.7 / 230 V (ph-N) 5 to 130 % of Un for Un = 100 / 400 V (ph-ph)				
Crest factor	2				
Measurement accuracy (U and V)	0.5 % from 20 % to 130 % of Un / Vn	0.2 % from 20 % to 130 % of Un/Vn			
Overvoltage	Transient U = 800 V for 24 hours Permanent 130 % of 400 V = 520 V				
Frequency	50/60 Hz	50/60 Hz or 400 Hz	50/60 Hz	50/60 Hz or 400 Hz	50/60 Hz
Consumption	< 0.1 VA	< 0.15 VA	< 0.1 VA		
Input impedance	0.45 MΩ	0.44 MΩ	1 MΩ		
<b>Current inputs (AC)</b>					
Measurement range	1 % to 130 % of In for In = 5 A				
Crest factor	3				
Measurement accuracy	0.5 % from ≥ 10 % to ≤ 130 %	0.2 % from ≥ 10 % to ≤ 130 % 0.5 % from ≥ 5 % to ≤ 10 % 1 % from ≥ 1 % to ≤ 5 %			
Acceptable overload	Transient I = 250 A for 1 second Permanent 130 % of 5 A = 6.5 A				
Consumption	< 0.15 VA				
<b>Compliance with standards</b>					
IEC62053-22	Active energy Class 1	Active energy Class 0.5 s		Active energy Class 0.2 s	
	Reactive energy Class 2	Reactive energy Class 0.5 s			
IEC61557-12 PMD SD/SS	V,I Class 0.5 P,S Class 0.5	V,I Class 0.2 P,S Class 0.5	Class 0.5	Class 0.2	Class 0.2
		Active energy Class 0.5 Reactive energy Class 0.5		Active energy Class 0.2 Reactive energy Class 0.5	
<b>Multi-measurement (accuracies)</b>					
Active power and energy	1 % for 5 % In ≤ I ≤ Imax	0.5 % for 5 % In ≤ I ≤ Imax		0.2 % for 5 % In ≤ I ≤ Imax	
Reactive power and energy	2 % for 5 % In ≤ I ≤ Imax	0.5 % for 5 % In ≤ I ≤ Imax			
Apparent power and energy	1 % for 5 % In ≤ I ≤ Imax	0.5 % for 5 % In ≤ I ≤ Imax			
Power factor (PF) and cosφ	± 0.05 counts when 0.5 inductive < PF < 0.5 ± 0.1 counts when 0.2 inductive < PF < 0.2 capacitive	± 0.02 counts when 0.5 inductive < PF < 0.5 capacitive ± 0.05 counts when 0.2 inductive < PF < 0.2 capacitive			
Frequency	± 0.1% from 42.5 to 69 Hz				
Sampling frequency	6.4 kHz to 50 Hz				
THD-I, THD-V and THD-U	± 0.5 counts				
Harmonics order by order	-				

	ENERIUM 30 Class I	ENERIUM 50/150 Class 0.5 s	ENERIUM 100/200 Class 0.5 s	ENERIUM 200 Class 0.2 s	ENERIUM 300 Class 0.2 s
<b>RS485 output</b>					
Connection	2 wires, half-duplex				
Protocol	ModBus / JBus RTU mode				
Speed (configurable)	2,400 - 4,800 - 9,600 - 19,200 - 34,800 ( 115,200 on ENERIUM 50/150)				
Parity	Even, odd or none				
JBus addresses	1 to 247				
<b>Ethernet output</b>					
Type	-	RJ45 - 8 pins			
Protocol	-	ModBus/TCP			
Speed (configurable)	-	Compatible with 10, 100 and 1,000 base T			
<b>Auxiliary power supply</b>					
Power supply	110 to 400 Vac (< 10 VA) 42.5 Hz to 69 Hz 155 to 565 Vdc	80 to 265 Vac (< 15 VA) 42.5 to 69 Hz 110 to 375 Vdc 19 to 57 Vdc (< 7.5 W)	80 to 265 Vac (< 20 VA) - 42.5 to 69 Hz 110 to 375 Vdc 19 to 57 Vdc (< 10 W)		
<b>Digital inputs (on-off or metering pulse)</b>					
Operating voltage	-	Up to 70 Vdc max	High level: 10 to 110 Vdc Low level: 0 to 5 Vac		
Min. signal width	-	High: 30 ms Low: 30 ms			
Consumption	-	< 0.5 W			
<b>Pulse or alarm relay outputs</b>					
Type	Static relay				
Operating voltage	70 Vdc max 33 Vac max	24 to 110 Vdc $\pm$ 20% 24 to 230 Vac $\pm$ 10%			
Max. current	100 mA	100 mA			
Compliance with standard	IEC 62053-31				
<b>Analogue inputs</b>					
Scale	-	-	Configurable between -20 to +20 mA		
Power consumption	-	-	< 50 mW		
Input impedance	-	-	50 $\Omega$		
<b>Analogue outputs</b>					
Scale	-	Configurable between -20 to +20 mA			
Acceptable overload	-	500 $\Omega$			
Response time	-	< 500 ms			
<b>Storage</b>					
No-volatile memory	Configuration parameters – Recordings (curves, alarms, min-max, qualimetry events log, IEC 50160 statistics)				
RAM	Capture of waveforms				
<b>Environmental specifications</b>					
Operating temperature	-10°C to +55°C (K55 according to IEC61557-12)				
Operating humidity	95% at 40°C				
Storage temperature	-25°C to +70°C				
<b>Safety specifications</b>					
Pollution	2				
Behaviour in fire	UL 94, severity V1				
Installation category	3				





### ► Accessories

Kit for DIN-rail or plate mounting



### ► Dimensions (in mm)

ENERIUM 30/50/150

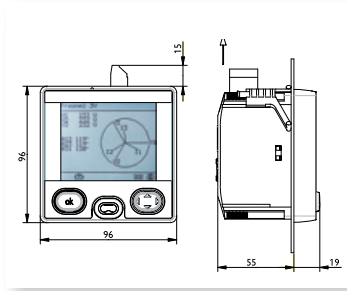

ENERIUM 100/200/300

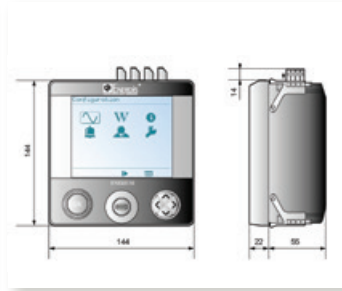

ENERIUM 110/210/310

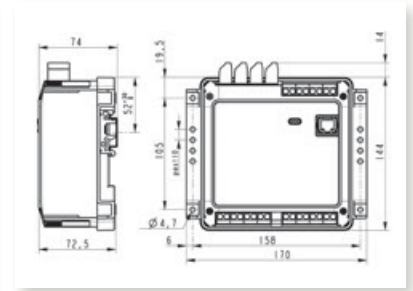

## TO ORDER

### ► Standard ENERIUM

Model	Frequency	Accuracy class	Power supply	Communication	On-off inputs	On-off outputs	Analogue outputs	Reference
ENERIUM 30	50/60 HZ	1	110 to 400 Vac / 155 to 565 Vdc	RS485	0	0	0	P01330823
ENERIUM 30	50/60 HZ	1	110 to 400 Vac / 155 to 565 Vdc	RS485	0	1	0	P01330824
ENERIUM 50	50/60 HZ	0.5 s	80 to 265 Vac / 110 to 375 Vdc	RS485	0	0	0	P01330805
ENERIUM 50	50/60 HZ	0.5 s	80 to 265 Vac / 110 to 375 Vdc	Ethernet	0	0	0	P01330806
ENERIUM 50	50/60 HZ	0.5 s	80 to 265 Vac / 110 to 375 Vdc	RS485	1	1	0	P01330807
ENERIUM 50	50/60 HZ	0.5 s	80 to 265 Vac / 110 to 375 Vdc	Ethernet	1	1	0	P01330808
ENERIUM 150	50/60 HZ	0.5 s	80 to 265 Vac / 110 to 375 Vdc	RS485	0	0	0	P01330809
ENERIUM 150	50/60 HZ	0.5 s	80 to 265 Vac / 110 to 375 Vdc	Ethernet	0	0	0	P01330810
ENERIUM 150	50/60 HZ	0.5 s	80 to 265 Vac / 110 to 375 Vdc	RS485	0	2	0	P01330811
ENERIUM 150	50/60 HZ	0.5 s	80 to 265 Vac / 110 to 375 Vdc	Ethernet	0	2	0	P01330812
ENERIUM 100	50/60 HZ	0.5 s	80 to 265 Vac / 110 to 375 Vdc	RS485	0	0	0	P01330831
ENERIUM 100	50/60 HZ	0.5 s	80 to 265 Vac / 110 to 375 Vdc	RS485	2	2	0	P01330832
ENERIUM 200	50/60 HZ	0.5 s	80 to 265 Vac / 110 to 375 Vdc	RS485	4	2	0	P01330833
ENERIUM 200	50/60 HZ	0.5 s	80 to 265 Vac / 110 to 375 Vdc	Ethernet	2	2	2	P01330834
ENERIUM 210	50/60 HZ	0.5 s	80 to 265 Vac / 110 to 375 Vdc	Ethernet	8	0	0	P01330835
ENERIUM 300	50/60 HZ	0.2 s	80 to 265 Vac / 110 to 375 Vdc	RS485	0	0	0	P01330816
ENERIUM 300	50/60 HZ	0.2 s	80 to 265 Vac / 110 to 375 Vdc	Ethernet	0	0	0	P01330817
ENERIUM 300	50/60 HZ	0.2 s	19 to 58 Vdc	RS485	0	0	0	P01330818
ENERIUM 300	50/60 HZ	0.2 s	19 to 58 Vdc	Ethernet	0	0	0	P01330819

### ► Accessories

Optical head for ENERIUM 50/150	P01330403
Optical head for ENERIUM 100/110 - 200/210 - 300/310	P01330401
DIN-rail mounting kit for ENERIUM 30/50/150	P01330830
DIN-rail mounting kit for ENERIUM 100/200/300	P01330360
690 V / 400 V resistive voltage adapter (for wind-turbine applications)	P01330402
Power supply for On-Off inputs 85 to 256 Vac/12 Vdc - 3.5 A (42 W)	ACCJ1004

### ► Software

E.set	P01330501
E.View	P01330601
E.View+	P01330610

## ► Configured products

### ENERIUM

1 2 3 4 5 6 7 8 9

#### 1 Model

50	ENERIUM 50 – Electrical energy – Load curves - Format 96 x 96
150	ENERIUM 50 + Trend curves - Format 96 x 96
100	ENERIUM 100 – Multi-energy - Trend curves - Format 144 x 144
110	ENERIUM 100 screenless version - Format 144 x 144
200	ENERIUM 100 + Load curves - Format 144 x 144
210	ENERIUM 200 screenless version - Format 144 x 144
300	ENERIUM 200 + Qualimetry
310	ENERIUM 300 screenless version

#### 2 Frequency of network measured

0	50/60 Hz
1	400 Hz (except on Enerium 100 / 200 class 0.5s / 300)

#### 3 Auxiliary power supply

0	80 to 265 Vac / 110 to 375 Vdc
1	19.2 to 58 Vdc

#### 4 Communication

0	RS485
1	Ethernet

Note: with choices 5, 6, 7 and 8, it is possible to have a maximum of 8 inputs and/or outputs (ENERIUM 100-110/200-210).

Note: for the Enerium 50/150, choices 5 and 6 only allow the following combinations: 0-0, 1-1, 2-0, 0-2.

#### 5 Metering (or On-Off) inputs

0	none
1	1 input (only on ENERIUM 50/150)
2	2 inputs
4	4 inputs (except on ENERIUM 50/150)
6	6 inputs (except on ENERIUM 50/150)
8	8 inputs (except on ENERIUM 50/150)

#### 6 On-Off outputs

0	none
1	output (only on ENERIUM 50/150)
2	2 outputs
4	4 outputs (except on ENERIUM 30/50/150)
6	6 outputs (except on ENERIUM 30/50/150)
8	8 outputs (except on ENERIUM 30/50/150)

#### 7 Analogue inputs (ENERIUM 100/200/300 only)

0	none
2	2 analogue inputs
4	4 analogue inputs
6	6 analogue inputs
8	8 analogue inputs

#### 8 Analogue outputs

0	none
2	2 outputs
4	4 outputs (except on ENERIUM 50/150)

#### 9 Accuracy class

5	0.5 s (except on ENERIUM 300)
2	0.2s (ENERIUM 200/210/300/310 only)

Example: Enerium 200, frequency 50/60 Hz, 80 to 264 Vac auxiliary power supply, RS485 communication, 2 on-off inputs, no on-off outputs, no analogue inputs, no analogue outputs, Class 0.2s  
=> order ENERIUM 200 01020002 • 1-200 • 2-1 • 3-1 • 4-0 • 5-2 • 6-0 • 7-0 • 8-0 • 9-2

## ► Associated products

Data retrieval solutions

► page 56



E.online monitoring software

► page 68



Current transformers

► page 102





# E.SET, E.VIEW and E.VIEW +

Configuration, installation diagnosis and display software for the ENERIUM range of power monitors

Associated software

Energy performance

## PRODUCT ADVANTAGES

- + CONFIGURATION**  
of the whole range of ENERIUM power monitors
- + DIAGNOSIS**  
of the installation
- + DISPLAY**  
of the electrical parameters
- + PROVISION**  
of the recordings in .txt format

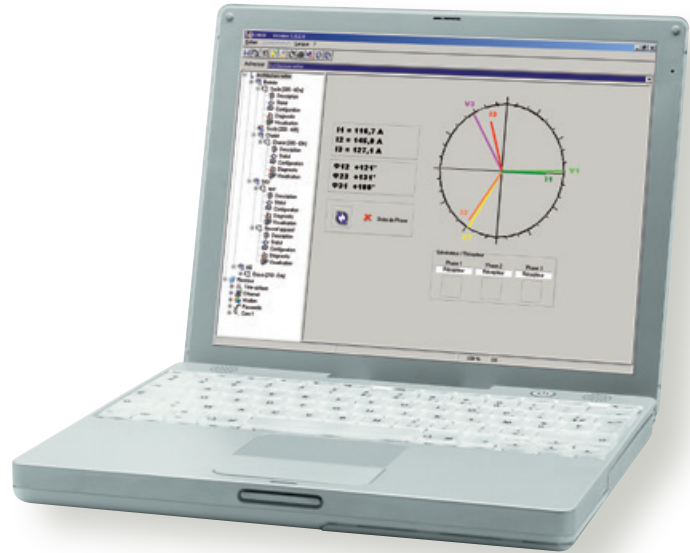

## ► Description

The **E.Set** software allows remote configuration of the power monitors in the ENERIUM range via the RS485 network, the Ethernet network or the optical head. With **E.Set**, it is possible to program at any time the products' communication parameters (address, speed, parity, etc.) and the configuration parameters (CT ratio, VT ratio, alarm thresholds, etc.).

**E.View** enables the inputs and outputs of the ENERIUM power monitors to be controlled remotely. **E.View** also allows display of the electrical parameters and retrieval in .txt format of the recordings of the load curves, the trend curves and the alarm log.

In addition, **E.View+** offers automatic elementary tables, bargraphs and curves.

Functionality	E.Set	E.View	E.View +
Description	•	•	•
Status	•	•	•
Configuration	•	•	•
Diagnosis		•	•
Display		•	•
Graphs			•

# E.SET

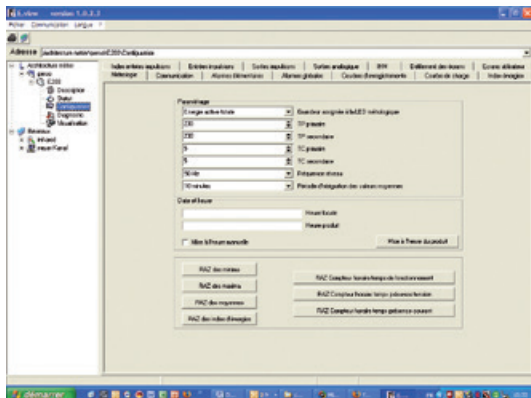

## ► Description

- The tabs are used to define the hardware status of the Enerium and the functional use of the inputs (on-off) and outputs (analogue or on-off)
- Details of the slots: analogue output card, on-off I/O card
- Communication (Ethernet, RS485)

## ► Configuration of the ENERIUM power monitors

- Configuration of the communication parameters
- Modification of the date and time
- Configuration of the CTs, VTs, alarm status, thresholds, etc.
- Adjustment and activation of the alarms
- Programming of the analogue outputs
- Programming of the inputs/outputs
- Zero reset of the meters, the overruns, the log, etc.

## ► Networking assistance

- Communication test on a power monitor chosen among the monitors in the RS485 or Ethernet network
- Automatic detection of all the products in the RS485 or Ethernet networks, with display of the communication parameters (address, speed, parity, stop bit) and the type of configuration (CT and VT ratios) for each power monitor

## ► Status

This page is used solely to view the status of the Enerium (voltage and current inputs, phase order, time synchronization, elementary alarms, global alarms, pulse and analogue outputs).

- Operation (correct or incorrect) of the voltage, current and phase order quantities
- Status of the global alarms
- Status of the elementary alarms
- Status of the pulse outputs and analogue outputs

## ► Backup and loading of configurations

- Saving and import of a configuration
- Downloading of a configuration from one power monitor onto another power monitor via the PC
- Writing of the new configuration
- Self-diagnosis of the configuration

## ► Customization of the screens

- Programming of the 3 customizable screens

## ► Means of communication

- Ethernet
- RS485/RS232
- Modem
- Optical head (infrared)

### TO ORDER

Model	Reference
E.Set software	P01330501

## ► Associated products

ENERIUM  
Power monitors

► page 38



ENERIUM  
Optical reading head

► page 46





## E.VIEW

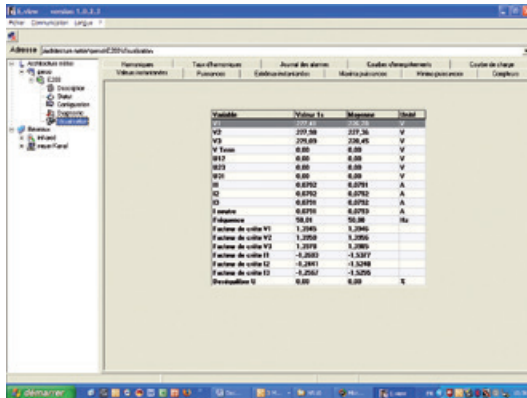

▶ Same basic characteristics as E.Set

▶ Display of the basic parameters

- Supervision of the electrical network by displaying the essential parameters measured by ENERIUM
- Consultation of the instantaneous and average values of the electrical quantities required to operate the electrical network
- Examples of display possibilities
  - Instantaneous values
  - Instantaneous extreme values
  - Maximum/minimum power values
  - Energy meters
  - Maximum odd harmonic values per order
  - Total harmonic distortion (THD)
  - Alarm log
  - Trend curves
  - Load curves

▶ Remote control of the inputs/outputs

All the inputs and outputs can be controlled remotely and separately. This function can be used, for example, to simulate an analogue output in order to verify the integration of an ENERIUM power monitor in the process.

▶ Retrieval of the records in .txt format

- Load curves
- Trend curves
- Alarm log

▶ Diagnosis of the installation

This page can be used to read the digital inputs, as well as to read and/or force the digital and analogue outputs of ENERIUM.

- This concerns:
  - Pulse inputs
  - On-off inputs
  - On-off outputs
  - Analogue outputs
- Detection of phase order reversal
  - Presence of voltage
  - Presence of current
  - Status of the current ratings being used by the power monitor
  - Indication of the generator/receiver mode of phases 1, 2 and 3
- Status of the alarms
- Status of the alarm relays
- Detection of external time synchronization errors
- Malfunction of an option card
- Saturation and possible loss of a pulse on the on-off outputs
- Trend curve memory occupancy
- Load curve memory occupancy

### TO ORDER

Model	Reference
E.View software	P01330601

▶ Associated products

ENERIUM  
Power monitors

▶ page 38



ENERIUM  
Optical reading head

▶ page 46



## E.VIEW +

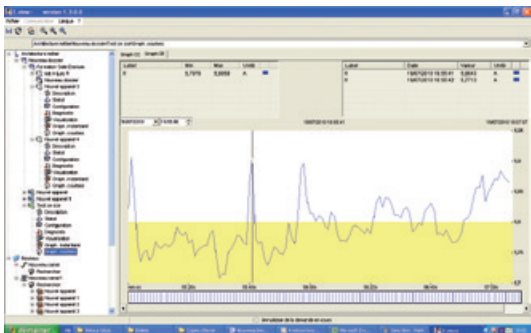

### ► Same basic characteristics as E.View

### ► Load curve graphing tab

Users have the possibility of viewing several quantities at the same time and positioning horizontal or vertical reference lines. A zoom function is also available. This tab includes an information area and tables for each curve.

### ► Trend curve graphing tab

The logic is the same as for the load curve graphing tab.

### ► Fresnel tab

This comprises 3 different tabs: 3V, 3I or 3V+3I. The information is refreshed in real time. For each of the tabs, there is an information area (mode: inductive/capacitive, receiver/generator, phase order OK or not).

Example: the Fresnel diagram of the 3 phase voltages (3V): instantaneous values of the phase voltages and the values of the phases.

### ► Harmonics tab in table format

- Harmonics order by order in V&I or U&I.
- The data is presented in table form.
- X axis: V1 [%] V2 [%] V3 [%] I1 [%] I2 [%] I3 [%]
- Y axis: the orders: 1, 2, 3 ... 50, with the possibility of other classifications: odd value multiple of 3, odd value not a multiple of 3, or even only.

### ► Harmonics tab in graph format

- 8 graph pages in bargraph format with the same logic as the table format:
  - 50 harmonic orders in V&I
  - 50 harmonic orders in U&I
  - Odd harmonics not a multiple of 3 in V&I
  - Odd harmonics not a multiple of 3 in U&I
  - Odd harmonics multiple of 3 in V&I
  - Odd harmonics multiple of 3 in U&I
  - Even harmonics in V&I
  - Even harmonics in U&I

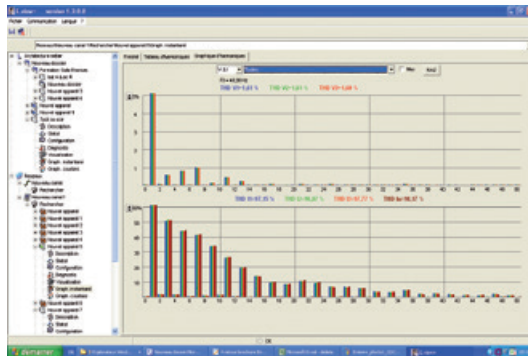

### TO ORDER

Model	Reference
E.View+ software	P01330610

### ► Associated products

ENERGIUM  
Power monitors

► page 38



ENERGIUM  
Optical reading head

► page 46







# RENOVENERGY

Metering solution for renovating installations

Metering solution

Energy performance



## PRODUCT ADVANTAGES

- + **COMPACT SOLUTION** for confined environments
- + **EASY IMPLEMENTATION** without cutting off the power
- + **COMPATIBILITY** with ULYS TTA, TT, Enerium 30 and Enerium 50
- + **RS485, Ethernet and M-Bus COMMUNICATION**



MID-certified ULYS TTA, TT for rebilling



TC CLIP transformers



One Ethernet output (Modbus TCP) RS485 output (Modbus/Jbus RTU)

## ► Description

**RENOVENERGY** is a metering solution which is easy to install. The **TC CLIP** current transformers from Enerdis®, used with **ENERIUM®** power monitors or **ULYS** energy meters, allow renovation, modernization and the addition of metering points in existing installations.

The current transformers in the **RENOVENERGY** range are specially designed for easy installation on existing electrical switchboards where the available space is often limited.

The **TC CLIP** range of transformers, available in versions from 100 to 600 A, can be installed without disconnecting the power cables from the existing installation. This can be done without cutting off the power supply, so it is quicker.

► The solution

General feeder solution



Submetering solution



► Metering selection guide



	ULYSTTA ULYSTT	ENERIUM 30	ENERIUM 50
<b>Network/connection</b>			
Single-phase 230 Vac or three-phase 230/400 Vac 50/60 Hz	●	●	●
Connection to TC Clip	●	●	●
<b>Mounting</b>			
Mounting	On DIN rail	Flush-mounting or DIN rail with Kit	Flush-mounting or DIN rail with Kit
Format	4 modules	96 x 96 mm	96 x 96 mm
<b>Energy consumption</b>			
Electrical energy consumed and produced	●	●	●
kWh / kVARh / kVAh	●	●	●
Partial index with zero reset	●	●	-
Tariff change input	●	-	-
IEC or MID certification (rebilling)	IEC or MID	IEC	IEC
Accuracy of active energy when used with the TC Clip range	1 %	1 %	1 %
Stored consumption curves (kWh, kVARh, kVAh)	-	-	●
Recording of the consumption on remote meters (pulse inputs)	-	-	●
<b>Monitoring / Analysis</b>			
Measurement of V, U, I, In, FP	●	●	●
Measurement of P, Q, S	●	●	●
Storage of Min and Max	-	●	●
Alarm management	-	●	●
Energy performance index (THD, tan φ, FP, cos φ)	-	●	●
Harmonic analysis up to 25th order	-	-	●
<b>Communication</b>			
Pulse or alarm outputs	1 to 2 pulse outputs	1 pulse or alarm output	1 pulse or alarm output
RS485 Modbus communication output	ULYS TT MODBUS	●	●
M-Bus communication output	ULYS TT M-BUS	-	-
Ethernet communication output	ULYS TT ETHERNET	-	●
Local connection via USB/optical head	-	-	●
Analogue outputs	-	-	●
Quick programming without software	●	●	-
Compatible with the E.online energy management software	●	●	●



► TC CLIP transformer selection guide



	TCC 176	TCC 241	TCC 242	TCC 364	TCC 366
<b>Primary</b>	60 A	100 A	250 A	400 A	600 A
<b>Secondary</b>	1 A				
<b>Accuracy class</b>	3%	1%			
<b>Diameter</b>	17 mm	24 mm	24 mm	36 mm	36 mm
<b>Dimensions (mm)</b>	64 x 33 x 34.4	75.5 x 45 x 34	75.5 x 45 x 34	91 x 57 x 40.5	91 x 57 x 40.5

TC CLIPs sold individually

<b>P01379609</b>	Single TCC 176
<b>P01379601</b>	Single TCC 241
<b>P01379602</b>	Single TCC 242
<b>P01379603</b>	Single TCC 364
<b>P01379604</b>	Single TCC 366

► Associated software

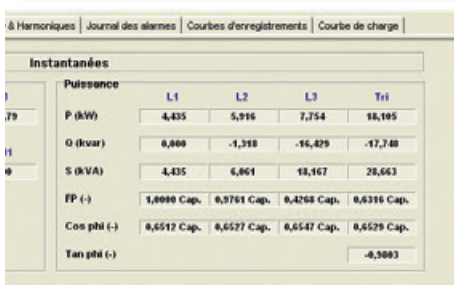
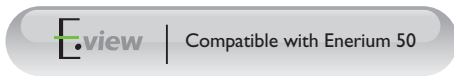

“Point-to-point” display software.  
 Demonstration version (limited to 29 days' use) delivered with each product.

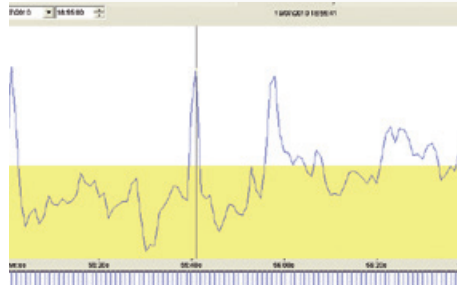
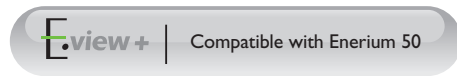

Advanced version of E.view including graph display.  
 Demonstration version (limited to 29 days' use) delivered with each product.

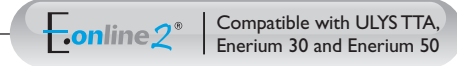
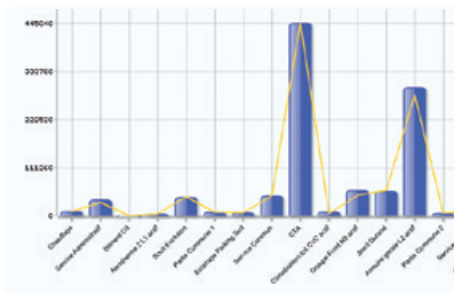

Software for simultaneous multi-product display.  
 Compatible with all meter/power monitor brands. Valuation in monetary units (€) and T.CO<sub>2</sub>, etc.

## TO ORDER

## General feeder solution



## Power monitors

<b>P01330823</b>	ENERIUM 30 – RS485 Modbus
<b>P01330824</b>	ENERIUM 30 – RS485 Modbus, on-off output
<b>P01330805</b>	ENERIUM 50 – RS485 Modbus
<b>P01330806</b>	ENERIUM 50 – Ethernet Modbus
<b>P01330807</b>	ENERIUM 50 – RS485 Modbus 1 on-off input - 1 on-off output
<b>P01330808</b>	ENERIUM 50 – Ethernet Modbus 1 on-off input - 1 on-off output



## Pack of 3 TC CLIPs

<b>P01379610</b>	PACK 3 TCC 176
<b>P01379605</b>	PACK 3 TCC 241
<b>P01379606</b>	PACK 3 TCC 242
<b>P01379607</b>	PACK 3 TCC 364
<b>P01379608</b>	PACK 3 TCC 366

## Submetering solution



## Energy meters

<b>P01331015</b>	ULYS TTA IEC
<b>P01331019</b>	ULYS TTA MID
<b>P01331035</b>	ULYS TT Modbus IEC
<b>P01331037</b>	ULYS TT-M Modbus MID
<b>P01331043</b>	ULYS TT M-bus IEC
<b>P01331045</b>	ULYS TT-M M-bus MID
<b>P01331039</b>	ULYS TT Ethernet IEC
<b>P01331041</b>	ULYS TT-M Ethernet MID



## Pack of 3 TC CLIPs

<b>P01379610</b>	PACK 3 TCC 176
<b>P01379605</b>	PACK 3 TCC 241
<b>P01379606</b>	PACK 3 TCC 242
<b>P01379607</b>	PACK 3 TCC 364
<b>P01379608</b>	PACK 3 TCC 366

## ► Associated products

ULYSKOM  
Communication modules

► page 36



E.SET, E.VIEW, E.VIEW+  
Software

► page 48



TC CLIP  
Current transformers

► page 121





# Data loggers and software

Energy performance

## Data loggers

**ELOG**  
Web-box data logger  
Unité de télérelève  
▶ page 58



**ENERIUM 210**  
Multi-energy and  
multi-utility data logger  
▶ page 64



**CCT**  
Pulse receiver  
▶ page 66



## Energy management and supervision software

**Processing  
software**

**E.ONLINE 2**  
▶ page 68



**Communication  
solutions**

▶ page 77



# Choosing your data logger

## Pulse receivers - Data logger

▶ page 58

▶ page 64

▶ page 66



**ELOG**



**Enerium 210**



**CCT**

		ELOG	Enerium 210	CCT
<b>Electrical energy management</b>	Accuracy		0,2 %	
	Measurement of V, U, I Inst. Min/Max Avg.		■	
	Measurement of P, Q, S Inst. Min/Max Avg.		■	
	Energy produced and consumed		■	
<b>Multi-energy management</b>	Pulse inputs for other meters (water, gas, etc.)	5	0, 2, 4, 6 or 8	0, 2, 4, 6 or 8
	Analog inputs 0-20 mA/4-20 mA (temperature, flow rate, pressure, insolation, etc.)		0, 2, 4, 6 or 8	0, 2, 4, 6 or 8
<b>Installation supervision</b>	Management of alarms on thresholds		16	-
	Alarms log (recordings)		64	50
	Fresnel diagram		■	-
	Pulse or alarm outputs		0, 2, or 4	-
	Analogue outputs		0, 2, 4, 6 or 8	0, 2, 4, 6 or 8
<b>Power quality</b>	THD / PF / Tan φ	-	■	-
	Harmonics by order with graphic representation	-	50	-
	Wave capture (U, V, I, In)	-	-	-
	EN50160 analysis	-	-	-
<b>Recording capacity</b>	Number of variable	50	12	8
	Recording periodicity	from 5 s to 60 min	from 1 s to 60 min	from 1 min to 60 min
<b>Inputs / Outputs</b>	RS485 - Modbus - Master	2	0	0
	RS485 - Modbus - Slave	0	1	1
	Ethernet	web services format JSON	Modbus TCP	
	Format (mm)	6 modules DIN	144 x 144	7 modules DIN
	Screenless version available	-	-	-





# ELOG

Web-box data logger

Data loggers

Energy performance

**PRODUCT ADVANTAGES**

- + COMMUNICATION**  
RS485, Master Ethernet
- + 50 TREND CURVES**
- + 5 PULSE INPUTS**
- + MULTI-EQUIPMENT INTEROPERABILITY**
- + WEB SERVICE**  
Web pages



5 On-Off pulse inputs



2 x RS485 ports (Modbus/RTU bus) Master mode



Ethernet port (Modbus TCP) Web master mode

## Description

**ELOG is a unit for automatic remote retrieval, recording and storage of energy, climate and process data** from meters, sensors, power monitors, PLCs, etc., connected to a communication network or equipped with pulse outputs.

- data logger for remote data retrieval and recording
- Multi-equipment, multi-brand drivers
- RS485 ModBus and Ethernet ModBus TCP master mode inputs
- web pages for configuration and supervision
- 5 pulse inputs for processing the metering data
- Web services for data processing

## ► Main functions

### ■ Remote data retrieval:

- in master mode on RS485 ModBus and Ethernet networks
- via the pulse inputs on multi-utility meters
- by driver with multi-brand and multi-function equipment
- of all types of data to be collected (water, gas, temperature, etc.)
- whatever the origin of the data (pulses, analogue signals, radio frequency, RS bus, Ethernet, etc.)

### ■ History of remote-retrieved data

- on 50 variables
- over a 3-month period for recording intervals > 1 minute
- over a 3-day period for recording intervals < 1 minute

### ■ Time/date-stamping of the recorded data:

- every 5, 6, 10, 12, 15, 20, 30 or 60 seconds
- every 1, 2, 3, 4, 5, 6, 10, 12, 15, 20, 30 or 60 minutes

### ■ Trend curves

- on the instantaneous values
- on the energy indices
- on a character string

### ■ Local and/or remote configuration

- via integrated web pages
- using a web browser
- with login/password

### ■ Viewing of the data in real time via integrated web pages

## ► Processing

### Web pages integrated in ELOG

It is not necessary to have a dedicated software solution or even a dedicated PC. All the **data** retrieved from the various types of equipment are **accessible** on any **computer, tablet** or **smartphone** equipped with a web browser.

### Office applications

An Excel application can be used to retrieve the data and view them in table or graph form.

### E.online 2 software

ELOG automatically synchronizes with the E.online energy performance monitoring, analysis and supervision software for remote retrieval and processing of all the recorded data.

### Multi-platform, multi-language application

The web services (in JSON with the http protocol) in ELOG can be used to access the real-time values and retrieve the recorded data, facilitating integration of the product in any system using multiple programming languages: java, javascript, python, C, C++, etc.



# Data loggers

Energy performance

## Functional diagram

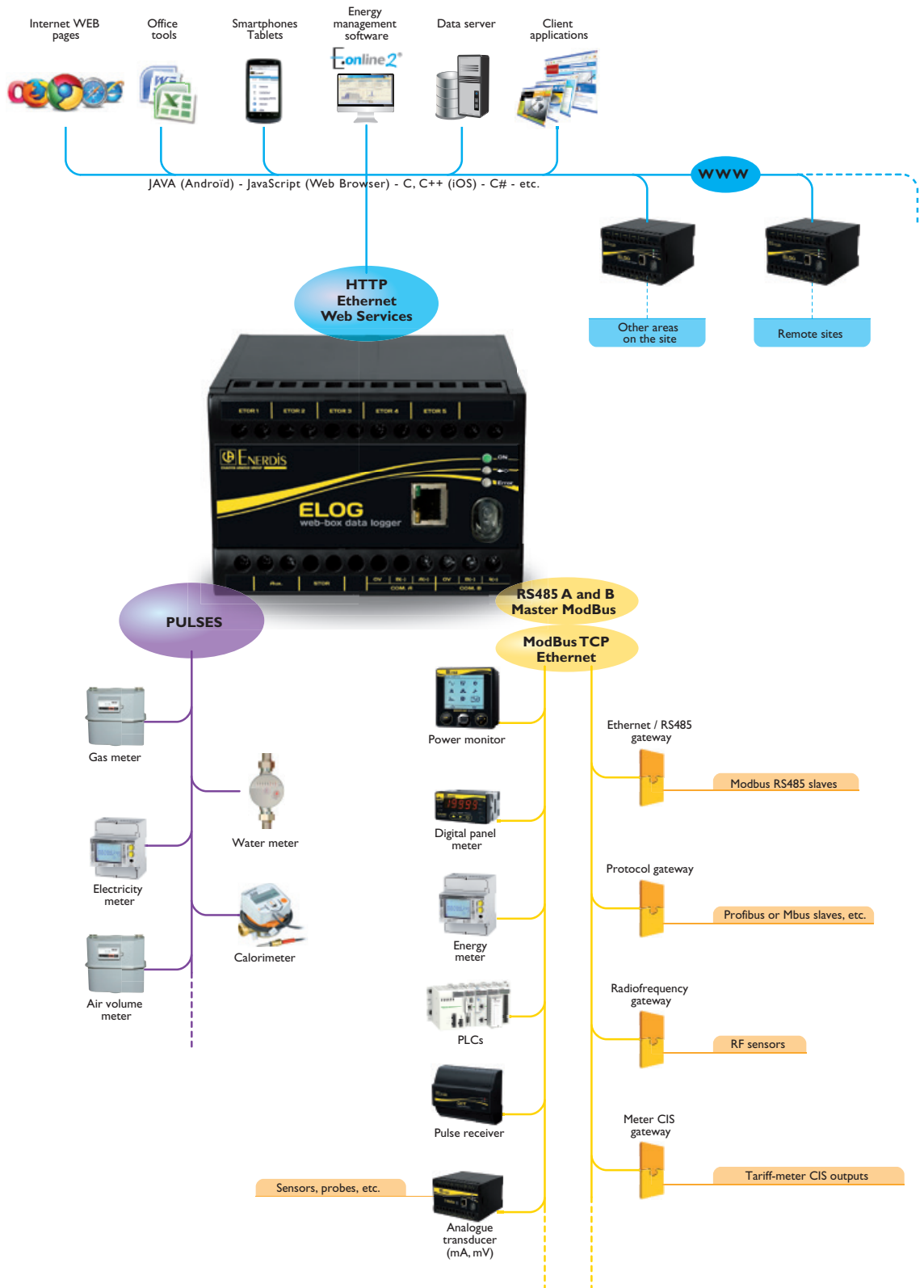

Photos: Chauvin Arnoux - Schneider Electric - Biter

## ► Inputs / Outputs

### ■ 5 pulse inputs (on-off)

- for connecting the metering pulse outputs of the multi-utility meters (electricity, water, gas, calories, etc.)
- the number of pulses emitted is proportional to the energy consumption measured by the meter
- for each input, ELOG continuously calculates and stores the consumption data

### ■ 2 x RS485 serial ports

- ModBus protocol in master mode
- for real-time readings of the variables and continuous recording of the values
- to communicate with multi-brand equipment compatible with the ModBus protocol

### ■ 1 x RJ45 Ethernet port

- in ModBus TCP master mode: for real-time readings of the variables and continuous recording of the values
- in web server mode: for configuring ELOG and viewing the variables in real time
- in Ethernet network mode: for integration in a global Ethernet network, remote processing of the data and retrieval of the stored data
- in processing mode via the web services

## ► Electrical specifications

Auxiliary power supply	
AC network	80 to 265 Vac - 10 VA - 42.5 to 69 Hz
DC network	80 to 375 Vdc - 7 W

Inputs	
Number of input	5
Operating mode	metering pulse input
Pulse interpretation	logic level 1: 12 to 72 Vdc logic level 0: 0 to 5 Vdc pulse duration: 30 ms min. at level 1 and then 30 ms min. at level 0 frequency : 0 to 16.67 Hz

## ► Communication

Communication interfaces	
RS485 A and RS485 B	type: 2 or 3-wire RS485 (shielding) protocol: ModBus RTU mode operation: master mode - half duplex reference standard: EIA485
Ethernet	type: RJ45 - 8 pins Protocols: HTTP in slave mode - ModBus TCP, encapsulated ModBus TCP in master mode speed: 10-100 baseT

Storage	
Recording periodicity	every 1, 2, 3, 4, 5, 6, 10, 12, 15, 20, 30 and 60 minutes every 5, 6, 10, 12, 15, 20, 30 and 60 seconds
Depth	3 months on per-minute data - 3 days on per-second data
Storage mode	Interchangeable memory card
Capacity	8 GB
Immunity to micro-outages	2.5 sec power reserve (at 230 Vac)

Clock	
Accuracy	±20 ppm (±20 sec every 11.5 days)
NTP synchronization	yes
Back-up	30 days max. in the absence of an auxiliary power source



### ▶ Functional limits

Max. number of configurable drivers	100
Number of simple variables per driver	30
Number of composite variables per driver	10
Max. number of devices.	100
Max. number of trend curves	50

### ▶ Mechanical specifications

Dimensions	120.5 x 120 x 81 mm (D x L x H)
Weight	560 g
Number of terminals	24 (20 used)
Connection	screw terminal strip
Cable cross-section	6 mm <sup>2</sup> single-strand - 4 mm <sup>2</sup> multi-strand
Tightening torque	0.4 Nm maximum admissible on the terminal

### ▶ Environmental constraints

<b>Climatic constraints</b>	
Rated operating temperature	-10 to +45°C
Operating temperature limit	-25 to +55°C
Storage temperature	-25 to +70°C
Relative humidity as per IEC 62052-11 (standard for electrical metering applications)	<75%, annual average 95% for 30 days spread naturally over the year 85% occasionally on other days
<b>Safety constraints</b>	
Standard	IEC 61010-1
Installation category	III
Pollution degree	2
Behaviour in fire	Complies with the UL94 standard, severity level V1
<b>Mechanical constraints</b>	
Protection rating according to IEC 60529	IP 20
<b>Electromagnetic constraints</b>	
Standards	IEC 62052-11 / IEC 61000-4-2 / IEC 61000-4-3 / IEC 61000-4-4 / IEC 61000-4-5 / IEC 61000-4-6 / IEC 61000-4-8 / IEC 61000-4-11 / CISPR22

## ► Dimensions (in mm)

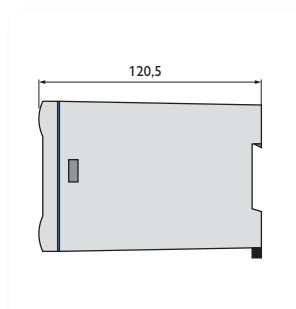

Drilling plan for mounting on switchboard

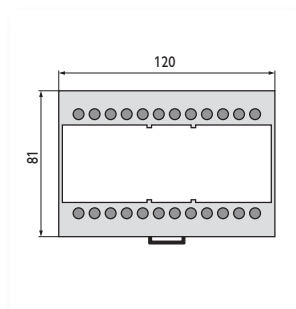
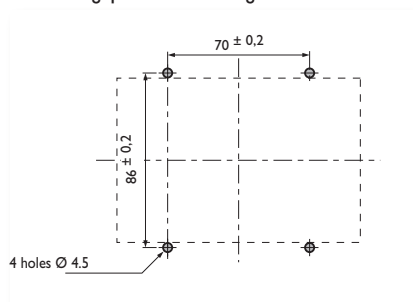

Accessory for mounting on switchboard with screws (option)

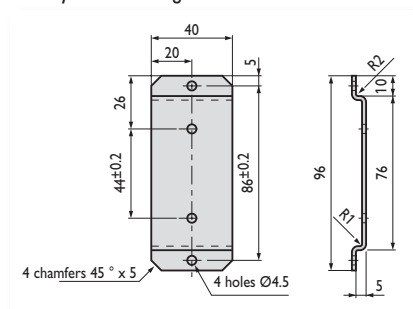

## TO ORDER

Model	Reference
ELOG	P01331230

## ► Accessories

Model	Reference
Switchboard mounting	ACCT 1006
Optical USB cable	P01330403

## ► ELOG ecosystem

Model	Reference
24 Vdc power supply for the pulse inputs	P01376001
CIS module - RS485 Modbus RTU	P01330377
USB cable for CIS module - RS485 Modbus RTU	P01330378
Radiofrequency module - RS485 Modbus RTU	P01330488
Multi-host Modbus / Ethernet gateway, DIN rail (power supply: P01376001)	P01330351

## ► Electrical connections

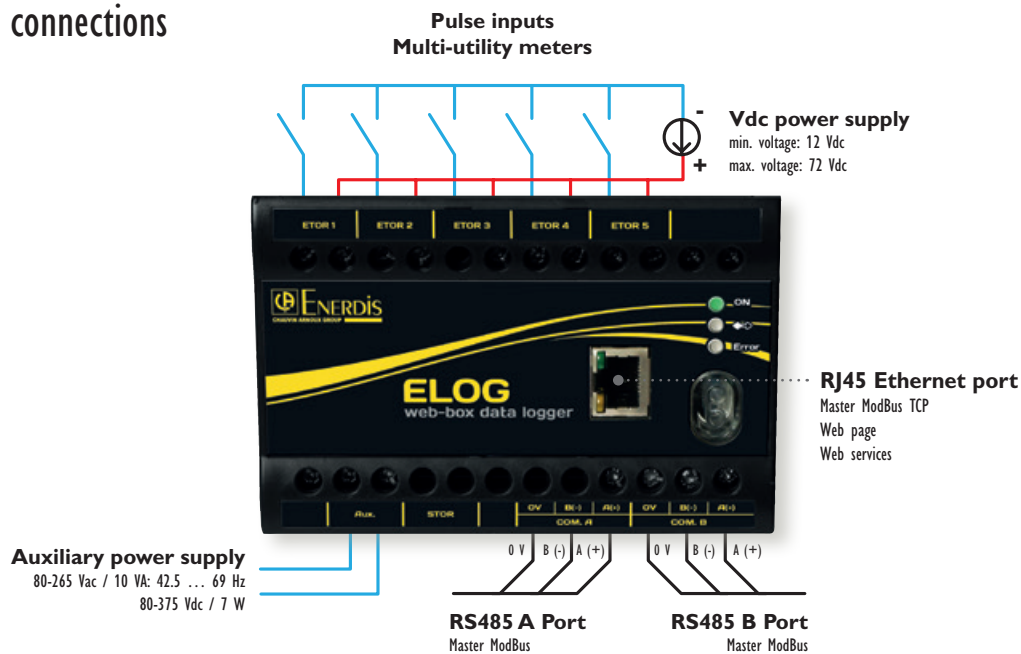

## ► Associated products

ULYS  
Energy meters

► page 6



ENERIUM  
Power monitors

► page 38



E.online  
Processing software

► page 68







# ENERIUM 210

Multi-energy, multi-utility data logger

Data loggers  
Energy performance

**PRODUCT ADVANTAGES**

- + 8 INPUTS**  
for acquisition:
  - On-off
  - analogue
- + ETHERNET & RS485 COMMUNICATION**
- + MULTI-ENERGY and multi-utility**



Programming and reading of the data by optical head



Ethernet output (Modbus TCP)  
RS485 output (Modbus/Jbus RTU)

## ► Description

**ENERIUM 210** is a multi-energy data logger which continuously records the data from meters (pulse output) or temperature or flow-rate **sensors** (0-20 mA / 4-20 mA signals). Equipped as standard with an RS485 ModBus or Ethernet ModBus TCP output, it allows remote data retrieval.

## ► Further information

- **Recording (8 load curves / 4 trend curves)**
- Multi-energy consumption indices and curves (water, gas, electricity, etc.)
- Temperature curves
- Trend curves

## ► Electrical specifications

Auxiliary power supply	
Supply voltage	80 to 265 Vac / 110 to 375 Vdc
Consumption	20 VA / 10 W
Digital inputs (on-off or pulses)	
Operating voltage	High level: 10 to 110 Vdc Low level: 0 to 5 Vdc
Min. signal width	High level: 30 ms Low level: 30 ms
Consumption	< 0.5 W
Ethernet output	
Type	RJ45 – 8 pins
Protocol	ModBus/TCP
Speed (configurable)	Compatible with 10, 100 and 1000 base T networks

## ► Mechanical specifications

Weight	700 g
Mounting	DIN-rail or plate mounting
Connection	screw terminal strip

## ► Environment

Operating temperature	-10°C to +55°C (K55 according to EN 61557-12)
Storage temperature	-25°C to +70°C
Relative humidity	95% to 40°C
Installation category	3
Pollution degree	2
Behaviour in fire	UL94, severity V1

### TO ORDER

Model	Reference
Enerium 210 - 50/60 Hz - 80 to 265 Vac / 110 to 375 Vdc - Ethernet - 8 metering inputs	P01330835

For the RS485 version, please contact us

Accessory	Reference
Optical head	P01330401

## ► Software

Model	Reference
E.view	P01330601
E.view+ / E.online 2	Consult us

## ► Associated products

ULYS  
Energy meters

► page 6



E.online  
Processing software

► page 68



## ► Dimensions (in mm)

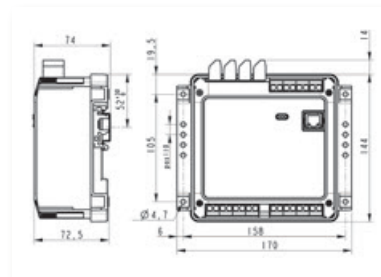

## ► Electrical connections

Please see ► page 42

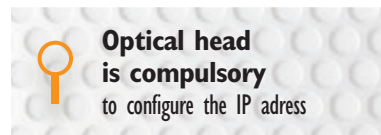



# CCT Range

Remote-readable pulse receiver

Data loggers  
Energy performance

## PRODUCT ADVANTAGES

- + With its **RS485 DIGITAL OUTPUT**, the **CCT** makes the **ULYS** range of energy meters particularly good at communicating. When used with these meters and the **E.online** energy management and monitoring software, it offers users a global solution for monitoring and managing all their metering points.
- + **CALCULATION** and **STORAGE** of load curves on the basis of the meters' pulse outputs.

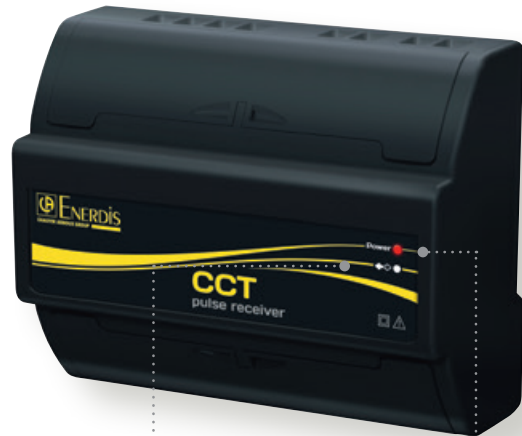

POWER LED: power supply presence (fixed: reset, flashing: battery fault)



COM LED: data exchange on the RS485 (flashing according to RS485 transmission speed)

## ► Description

The **CCT** collects and stores pulses coming from different energy meters (electricity, water, gas) or digital signals (circuit breaker status, alarm triggering, etc.) in real time, and transmits the information to an energy management system, such as **E.online**, via its RS485 digital link.

## ► Special features

The **CCT** accepts all types of metering measurement units (m<sup>3</sup>, m<sup>3</sup>/h, litres, kWh, etc.). 8 inputs can be programmed individually as metering-pulse inputs or digital inputs.

Pulse inputs:

- Energy management: recording of load curves of the last 4,032 average values for active and reactive powers for each of the 8 input channels (for example, 28 days of recording with a 10-minute integration period).
- Recording of the last 12 monthly metering indices and general indices.

Digital input:

- Counting and time-stamping of events: time-stamping of status change of a digital input and recording of all digital input statuses.
- Recording of the last 50 status changes.

## ▶ Electrical specifications

Pulse/digital inputs	
Pulse weight	from 0.1 to 100
Stream integration time	1 to 60 minutes, in 1-minute increments
Pulse input voltage	24 to 60 Vac/dc $\pm$ 20%
Consumption	0.1 VA to 24 Vac/dc 0.5 VA to 48 Vac/dc
Pulse duration	30 to 1500 ms
Auxiliary power supply	
Supply voltage	230 Vac
Domain of use	-20% / +15%
Consumption	5 VA
Power supply output	
Metering inputs	24 Vdc – 100 mA
Digital outputs	
1 RS485 output / 2 shielded wires + half-duplex	
Protocol	ModBus/Bus RTU mode
Speed	600, 1200, 2400, 4800, 9600 and 19200 bauds
Parity	Even, odd or no parity
Stop bits	1 or 2
Bus addresses	1 to 255

## ▶ Environment

Operating temperature	-20°C to +55°C
Storage temperature	-25°C to +70°C
Relative humidity	95%
Data storage	10 years at +25°C
Installation category	3
Pollution level	2

## ▶ Mechanical specifications

Weight	450 g
Mounting	Mounting on DIN rail
Terminal	6 mm <sup>2</sup> screw connection terminals

Model	Reference
CCT Remote-readable pulse receiver	CCCT 1001

## ▶ Associated products

ULYS energy meters

▶ page 6



E.online monitoring software

▶ page 68



SESAME configuration software

▶ contact us



## ▶ Dimensions (in mm)

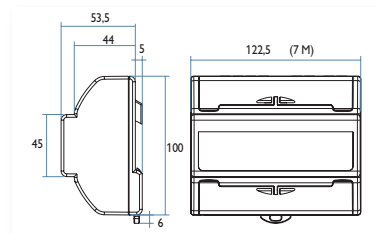

## ▶ Electrical connections

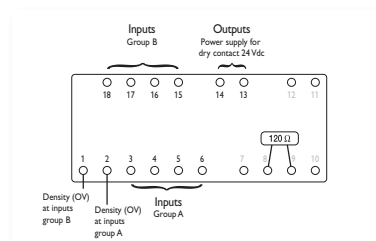

## ▶ Auxiliary power supply

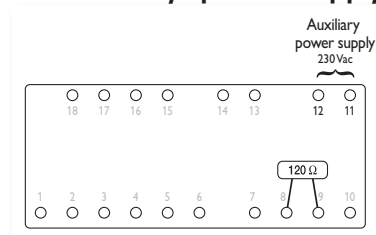

## ▶ Communication

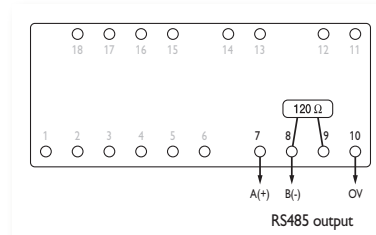



# E.ONLINE Range

Multi-energy consumption measurement and management software

Management and supervision software

Energy performance

**PRODUCT ADVANTAGES**

- + **AUTOMATIC REMOTE DATA RETRIEVAL** from meters, power monitors and PLCs
- + Customized **DASHBOARDS**
- + **MULTI-SITES, MULTI-USER, MULTI-ENERGY** management
- + **PRINTING / EMAIL DISTRIBUTION** of energy reports and alerts
- + **REAL-TIME DISPLAY** of measurements
- + **CALCULATION FUNCTIONS** and mathematical formulae

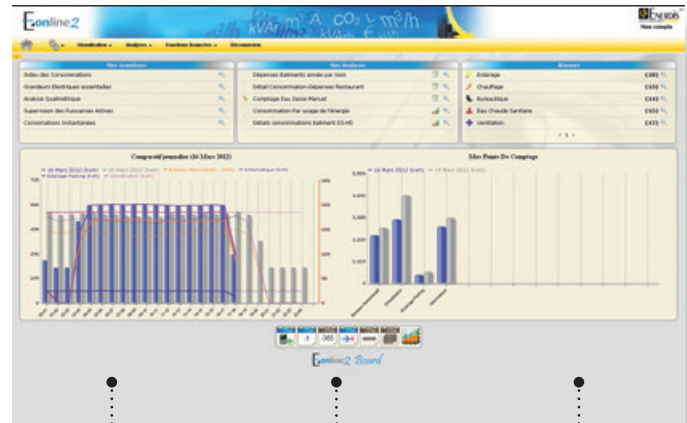

Detailed, interactive, structured analysis of consumption



Management of alerts on threshold overruns (consumption, ratio, etc.)



Real-time display of measurements and consumption data

## ► Descriptions

**E.online** is **software** specially designed for controlling, monitoring, managing and supervising consumption. Its dedicated functions make it an effective tool for improving and supervising energy performance.

E.online is a useful tool for energy actors in industry; the tertiary sector and infrastructures.

The software's main functions are:

- Automatic collection of the data from meters, power monitors, PLCs, etc.
- Real-time display of all the measurements
- Presentation of the results in energy units, accounting units, carbon footprint units, etc.
- Printing and automatic email distribution of alerts and energy reports
- Definition of ratios and standard or specific energy performance indices
- user profile by customizing the application via dashboards, dedicated reports, information authorization functions
- etc.



**E.online can be accessed via a simple web browser WEB** (Firefox, Google Chrome, Internet Explorer, etc.) using a profile and password specific to each user.

The **global solution** comprises **several parts**:

- 1 measuring instruments,
- 2 accessories and communication solutions,
- 3 computer resources
- 4 E.online software.

ENERDIS can handle all the stages and proposes technical solutions for all the parts. To guarantee optimum, long-term operation and immediate use, ENERDIS provides verification, commissioning and training services. The maintenance contract completes the set of services for long-term monitoring of the installation and updates.







 This symbol identifies major advantages.

## ► Description

### Dashboard

This can be customized for each E.online2 user profile. On a single page, it provides a real-time overview of the changes in consumption compared with a history, displays the alarms in progress and constantly updates the energy reports defined.



- 1
  - **Real-time evolution** of the measurements, consumption data, ratios, indices, etc.
  - Display of the values for **hours, days and months**
  - **Immediate comparison** with the history: day-1, month-1, year-1
  - Tracing of the temperature, performance indicator, etc., with **superimposed curves**
  
- 2
  - **Real-time evolution** of the consumption data by energy usage, utility, category, building, industrial process, etc.
  - **Display for the current day, month or year**
  - **Immediate comparison** with history of day-1, month-1 and/or year-1
  
- 3
  - Display of **alarms in progress**
  - Access to the alarms log (details of the alarms, acknowledgement function)
  
- 4
  - **Display of constantly-updated** analyses and reports
  
- 5
  - Access to **customized pages** for viewing **real-time measurements**

## Real-time display / alerts and overruns

The measurements from ENERDIS® instruments and multi-manufacturer products can be displayed in real time on standard or customized pages.

The multi-windowing functions can be used to display several viewing screens simultaneously.

An instrument can be selected in a tree-structure diagram of the installation.

Users can program alarms to generate threshold overrun alerts automatically.

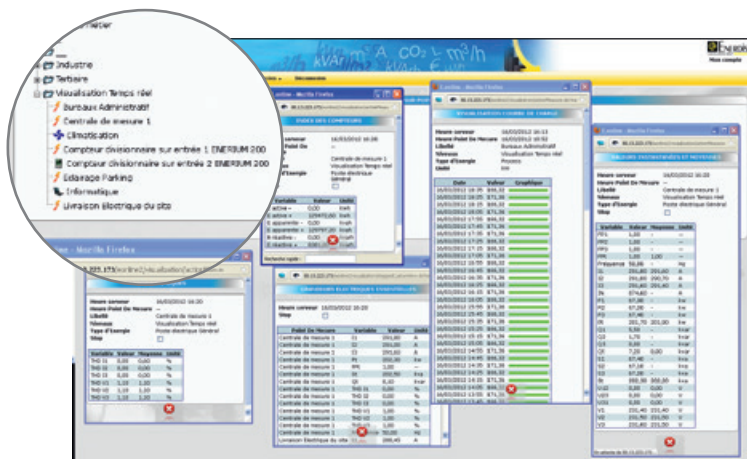

- Display of the **quantities measured** by the instruments (energy index, voltage, current, active, reactive and apparent power values, tangent phi, frequency, harmonics, flow rate, etc.)
- Management of the **ENERDIS® products and multi-manufacturer instruments** already in place
- Configuration of **multi-product and multi-quantity** display pages
- Scheduling of **measurement sessions** on selected products and measured quantities (recorded data exportable in csv format)

- Configuration of **multi-level thresholds** on measured or calculated quantities
- **Distribution of email alerts** for any values outside the programmed profiles
- Identification of the **overruns in the reports** using specific colours
- **Detailed description of the alert** (min. or max. values reached, time/date-stamping and duration of the overrun, threshold values, etc.)

		Masquer		Masquer	
		4 Octobre	5 Octobre	6	
Chauffage	Chauffage	57,94	39,26	21,7	
Climatization	Climatization	51,50	34,90	19,33	
Eau Chaude Sanitaire	Eau Chaude Sanitaire	6,44	4,36	2,42	
Détriage	Détriage	49,35	33,45	18,54	
Informatique	Informatique	19,31	13,09	7,26	
Total		184,54	125,06	61	



## Energy analyses and reports

The energy analyses and reports printed on request (or constantly updated) can be used to detail the evolution of consumption, energy performance indices and all the data from the measurements or the E.online2 calculation functions. Using the energy indices retrieved remotely for the simplest instruments and the consumption trend curve for the more advanced, E.online2 stores and logs the data to print out reports in table and graph form.

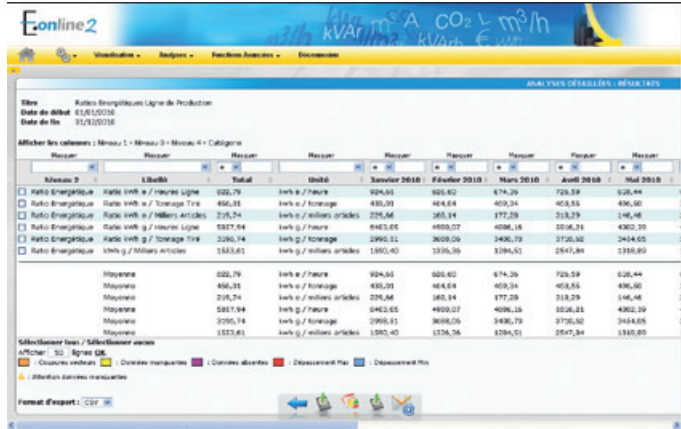

- Display of the **measured and calculated data** (consumption, temperature, production data, building occupancy rates, performance index, ratio, etc.)
- **Multi-energy tables** in measured, Carbon-footprint, financial and specific units
- Display of data **per hour, day, month, year or between two dates without restrictions**
- **Comparison of data** per period, process, energy type, etc. (benchmarking)

- **Observation of the evolution** of consumption data and energy spending
- Instantaneous generation of **graphical analyses**
- Configuration of energy **tariff contracts**
- Data **Sorting** and **Filtering** functions
- **Detection of incomplete data** (mains outages, communication errors, absence of measurements, etc.)
- **Recording of analysis templates** (library)
- **Export** of analyses in html, pdf and csv formats
- Instantaneous generation of **graphical analyses**
- **Identification** of the most energy-hungry work areas and periods (PARETO graph)
- **“Zoom-in” function** for zooming from the macro level (year) to the micro level (10 min. values) simply by clicking
- **Graphic representation** (bar / pie)
- **Superimposition of data** (e.g. Temperature vs. consumption)
- Etc.

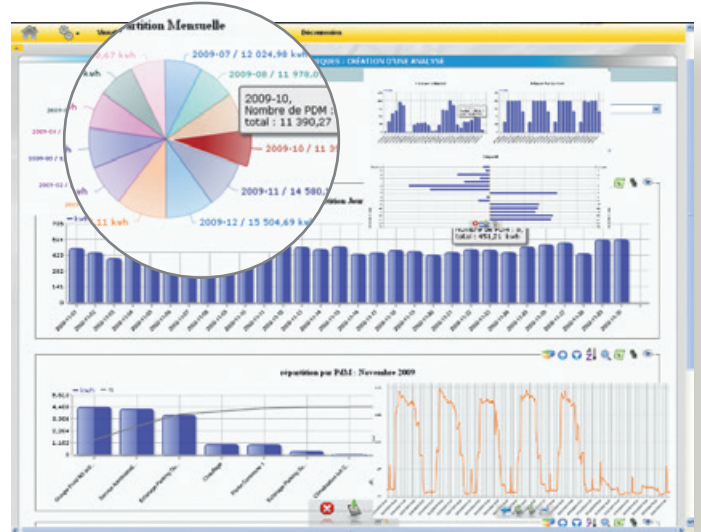

## Manual input

Acquisition of the data needed to draw up an energy overview of a system cannot always be automatic (e.g. production data, electromechanical meter, building occupancy rate, etc.).

E.online2's manual input tools can be used to build up the most exhaustive database possible.

The screenshot shows the 'SAISIE MANUELLE : MODIFIER' interface in E.online2. It features a navigation bar with 'Visualisation', 'Analyses', 'Fonctions Avancées', and 'Déconnexion'. Below the navigation, there are tabs for 'Nom & Type', 'Choix des Points De Mesure', and 'Saisie des données'. A year selector shows '2010'. The main area displays a table with columns for 'Libellé', 'Niveau 2', 'Niveau 3', 'Unité', and months from 'Janvier 2010' to 'Avril 2010'. The table contains data for various energy metrics like 'Heures de Fonctionnement', 'Energie Active Ligne de Production', 'Gaz Ligne de Production', and 'Tonne de Matière Utilisée'.

Libellé	Niveau 2	Niveau 3	Unité	Janvier 2010	Février 2010	Mars 2010	Avril 2010
Heures de Fonctionnement	Production	Données de Production	Heures	2364.00	3937.00	6095.00	8089.00
Energie Active Ligne de Production	Production	Consommations Energétiques	kWh	1659911.00	3114378.00	4466589.00	5811261.00
Gaz Ligne de Production	Production	Consommations Energétiques	kWh	11722000.00	21794000.00	32541000.00	42284000.00
Tonne de Matière Utilisée	Production	Données de Production	Tonnes	3532.00	6891.00	9805.00	12670.00
Milliers Articles Produits	Production	Données de Production	milliers articles	8700.00	15033.00	23075.00	30660.00

- Types of data input: **cumulated index, index difference, average and instantaneous values**
- Interface for inputting values for the **hours, days, months or years**
- Used for **energy reporting, ratios, virtual devices, formulae, etc.**

## Calculation functions (virtual device, ratio, formulae, conversion rules)

Analysis of a system's or organization's energy performance sometimes requires the calculation of a large number of parameters using simple (division, addition, subtraction, etc.) or complex formulae.

The conversion function can be used to display the results in several units (e.g. kWh<sub>ef</sub>, kWh<sub>ep</sub>, TCO<sub>2</sub>) or to convert a measurement unit into a contractual unit (e.g. cubic metre of gas into kWh)

The screenshot shows the 'ANALYSE DÉTAILLÉE - METERS' interface. It displays a table with columns for 'Niveau 1', 'Libellé', 'Total', and months from 'Janvier 2009' to 'Mai 2009'. The table lists various energy consumption categories like 'Bâtiments 02 - H0', 'Climatisation', and 'Postes de consommation par Usage'. The data is presented in a grid format with multiple columns for each month.

Niveau 1	Libellé	Total	Janvier 2009	Février 2009	Mars 2009	Avril 2009	Mai 2009
Bâtiments 02 - H0	POURCE H0	224502.02	119704.27	118733.12	128533.36	102993.63	100877.72
Climatisation	Refroidissement des Bâtements	2003.09	2006.36	2003.60	2003.60	2003.09	2006.36
Postes de consommation par Usage	Occupation du Bâtement	3003.47	3003.09	3006.36	3003.47	3003.09	3003.09
Postes de consommation par Usage	Éclairage	1.01	1.14	0.69	0.82	0.08	0.87
Postes de consommation par Usage	Éclairage	3003.47	3021.91	3444.64	3444.61	3444.67	3444.79
Indicateurs Performance	Consommation / ep	3.09	3.09	3.09	3.09	3.09	3.09
Indicateurs Performance	Consommation / ep	3.09	3.09	3.09	3.09	3.09	3.09
Total		225505.29	120949.45	118986.48	129534.85	104280.55	100983.73
Moyenne		2003.09	2006.36	2003.60	2003.60	2003.09	2006.36
Total		1.01	1.14	0.69	0.82	0.08	0.87
Moyenne		3.09	3.09	3.09	3.09	3.09	3.09
Moyenne		3.09	3.09	3.09	3.09	3.09	3.09

- Arithmetical functions (summing, subtraction) on the devices, e.g. sum of consumption:
  - per usage (lighting, air-conditioning, heating, auxiliary, etc.)
  - per utility (electricity, water, gas, etc.)
  - per entity (company, department, production unit, etc.)
- Configuration of energy Performance Indices
  - (kWh EP/m<sup>2</sup>), (kg eq-CO<sub>2</sub>/m<sup>2</sup>), (m<sup>3</sup>/m<sup>2</sup>), (kg waste/m<sup>2</sup>), etc.
  - (kWh/unit produced), (kWh/operating hours), etc.
- Conversion of the data into contractual units (primary energy, TCO<sub>2</sub>, etc.) in the results of energy overviews
- Conversion of the volumes measured (m<sup>3</sup> of gas) into kWh



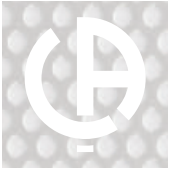

### Generic driver

The generic driver function enables E.online2 to communicate with other manufacturers' products in addition to ENERDIS instruments.

The generic drivers for products from the main manufacturers are available in a library.



- **Communication with all ModBus and ModBus-TCP products**
- **Integration of the communication products already in place on the installation**
- Calculation of the consumption profiles (trend curves) from the energy indices
- Management of a **library of reusable drivers**

### SQL connector

The SQL connector is used to create a link (ODBC link) between the E.online2 database and a third-party system database (TBM, CTM, ERP, etc.). The data are updated periodically and automatically by E.online2.



- **Automatic updating** of the data in the mySQL tables
- **Standard reading of the tables via ODBC link**

## ► Radiofrequency solution

On some sites, it is sometimes complex and **technically costly to operate devices which are isolated** or remote from any existing communication structures on the site (Ethernet network, wired bus, etc.).

This is very often the case for water and gas meters installed outside the main buildings. The absence of a power supply **also prevents the use of conventional operating modes** such as communicating meters or pulse receivers.

**The Radiofrequency solution is particularly suitable** for this type of configuration. The meter's pulse output is simply connected to a Radiofrequency module equipped with an autonomous internal power supply. The consumption data (e.g. hourly energy indices) are transmitted periodically by radio waves to a remote data logger. The data logger can handle several tens of Radiofrequency modules.

Radiofrequency modules can also be used to record 4-20 mA signals and temperatures.

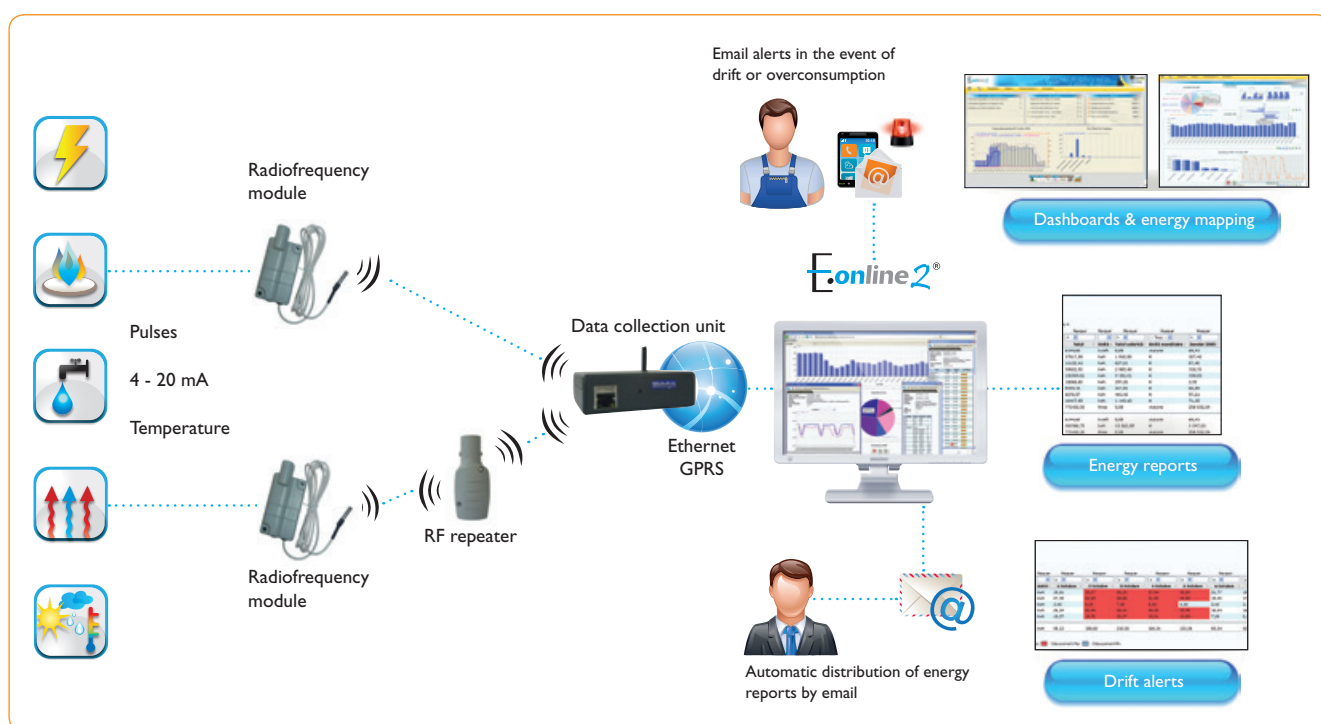

## ► Technical data concerning the E.online software

- Web application
- Installation on Server (multi-station) or dedicated PC (single-station)
- Use from a Web browser
- Server application: compatible with Windows Server 2003, Windows Server 2008, Windows Server 2012
- Dedicated PC application: compatible with Windows XP PRO, Windows Vista and Windows 7
- Connection to E.online by means of a user name and password
- Remote retrieval engine: C++ technology
- Application server: Apache Tomcat with JAVA J2EE technology
- Web interface: Ajax, Flash
- DBMS (database management system): MySQL





T O O R D E R

▶ **E.online2<sup>®</sup> without options**

Model	Metering points	Reference
E.online 2 single-station	15	P01335050
E.online 2 single-station	30	P01335060
E.online 2 single-station	50	P01335070
E.online 2 server	15	P01335055
E.online 2 server	30	P01335065
E.online 2 server	50	P01335075

▶ **E.online2<sup>®</sup> configurable version**

Version	Single-station or server version
Max. number of devices	between 15 and 1,000
Max. number of user profiles	between 1 and 250 <sup>(1)</sup>
Options	Manual input generic driver SQL connector

(1): One administrator account by default

▶ **Radiofrequency solutions**

Model	Reference
RF module, 1 pulse input	P01330380
RF module, 2 pulse inputs	P01330381
RF module, 4 pulse inputs	P01330382
RF module, 1 pulse input, ATEX	P01330383
RF module, 1 temperature input (integrated probe)	P01330384
RF module, 2 temperature inputs (integrated probes)	P01330385
RF module, 1 x 4-20 mA analogue input	P01330386
RF module, 1 pulse input, with interchangeable battery	P01330480
RF module, 2 pulse inputs, with interchangeable battery	P01330481
RF module, 4 pulse inputs, with interchangeable battery	P01330482
RF module, 1 ATEX pulse input, with interchangeable battery	P01330483
RF module, 1 temperature input (built-in probe), with interchangeable battery	P01330484
RF module, 2 temperature inputs (built-in probes), with interchangeable battery	P01330485
RF module, 1 x 4-20 mA analog input, with interchangeable battery	P01330486
Interchangeable battery for module	P01330487
Radiofrequency repeater	P01330387
Radiofrequency data logger – Ethernet output	P01330388
Radiofrequency data logger – GPRS output	P01330389
5 m remote RF antenna	P01330489
10 m remote RF antenna	P01330490
20 m remote RF antenna	P01330491

## ► Communication solutions

<b>Ethernet</b>	
Multi-host JBUS / Ethernet gateway, DIN rail - 24 Vdc (power supply: P01376001)	P01330351
230 Vac / 24-48 Vdc 30 W power supply, DIN rail	P01376001
4 x RS485 / Ethernet repeaters/dispatchers - 230 Vac	P01330375
Mounting bracket for 4 x RS485/ Ethernet repeaters/dispatchers	P01330374
RS485 - RJ10 cable for 4 x RS485/ Ethernet repeaters/dispatchers	P01330376
5-port Ethernet switch, 10-100 BaseTx - 10 to 60 Vdc (power supply: P01376001)	01NC5503
WS250 ADSL router modem - 10 to 28 Vdc (power supply: P01376001)	P01330361
DGCW 3G router modem - 230 Vac	P01330370
Omnidirectional remote antenna, 3G DGCW router	P01330371
Directional remote antenna, 3G DGCW router	P01330372
FME-SMA adapter for directional antenna	P01330373
Mounting bracket for 3G DGCW router	P01330374
3G WS310 router modem - 10 to 60 Vdc (power supply: P01376001)	P01330362
External antenna for 3G - WS310 - WS330 router modem	P01330363
Self-powered RS485 Modbus - USB converter	P01330365
<b>Serial link</b>	
RS485/RS232 CONVERTER - DIN RAIL - 230 VAC	P01330350
2 x RS485/RS485 repeaters/dispatchers - 19.2 to 28.8 Vdc (power supply: ACCJ1003)	ACCJ1002
Power supply for 2 x RS485/RS485 repeaters/dispatchers	ACCJ1003
4 x RS485/RS485-RS232 repeaters/dispatchers - 230 Vac	ACCJ1001
<b>STN and GSM link</b>	
STN - RS232 desktop modem - 230 Vac	MODV2000
STN modem, DIN rail, RS485, ROHS - 230 Vac	P01330352
STN modem, DIN rail, RS485 - 12 Vdc (power supply: ACCJ1004)	MODV2002
230 Vac/12 Vdc - 12 VA power supply	ACCJ1004
STN modem, RTC DIN rail, GSM - RS485 WS - 9.6 to 57.6 Vdc (power supply: P01376001)	P01330379
<b>Radiofrequency</b>	
RF-RS485-ETH-WS80 modem	01NC5503
Radiofrequency / RS485-RS232-Ethernet gateway / 10 to 30 Vdc (power supply: P01376001)	01NC5503
RF-RS485 Modbus RTU-WS805U modem	01NC5503
Radiofrequency / RS485 Modbus RTU gateway / - 10 to 30 Vdc (power supply:P01376001)	01NC5503
Remote antenna for RF-RS485-ETH-WS80 and WS805U modem	01NC5503
4 m cable for remote antenna	01NC5503
FME-SMA adapter for remote antenna	01NC5503
Radiofrequency - RS485 Modbus RTU module	P01330488



# Analyzers

▲ Power Quality

## Power quality analyzers

### Permanent analyzers - MAP range - Class A

**MAP 607**  
Single-phase voltage  
quality analyzer  
▶ page 85



**MAP 610**  
Three-phase voltage  
quality analyzer  
▶ page 84



**MAP 620**  
Three-phase  
voltage/current power  
quality analyzer  
▶ page 84



**MAP 640**  
Three-phase voltage/current  
power quality analyzer with  
HF transient capture  
▶ page 84



**MAP Compact**  
Three-phase voltage/current  
power quality analyzer  
+ Energy - Monitoring of  
EN50160 template  
▶ page 91



### Power quality monitor

**ENERIUM 300**  
Power monitor  
Qualimetry according to EN50160  
▶ page 38



### Non-intrusive analyzers - MAP range - Class A

**MAP 612-NI**  
Non-intrusive three-phase  
voltage quality analyzer with  
quick connection  
▶ page 87



**MAP 620-NI**  
Non-intrusive power  
analyzer - three-phase  
voltage/current  
▶ page 87



# Management and analysis software

## For MAP 607

### Qual-SRT

Configuration and  
real-time display software  
▶ page 93



### Qual-View

Analysis software for  
measurement campaigns  
▶ page 93

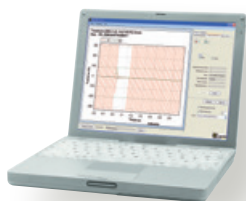

## For MAP Compact

### Qual-SRTc

Configuration and  
real-time display software  
▶ page 92



### Qual-View

Analysis software for  
measurement campaigns  
▶ page 92

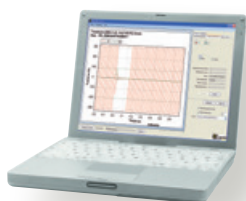

### E.Qual-Premium Server

Management software for "medium  
and large configurations".  
Client/server software for configuration,  
automatic data retrieval, multi-equipment  
analysis, statistical display, report generation  
and management of the measurements  
in a database  
▶ page 94



## For MAP 6XX range

### E.Qual-Premium

Management software for  
"small configurations".  
Point-to-point software  
for configuration, data retrieval,  
analysis and report generation  
▶ page 94



### E.Qual-Premium Server

Management software for  
"medium and large configurations".  
Client/server software for configuration,  
automatic data retrieval, multi-equipment  
analysis, statistical display, report generation  
and management of the measurements  
in a database  
▶ page 94







# Choosing your power quality analyzer

▲ Power Quality Analyzers

► Based on its specifications

	Permanent analyzers			Non-intrusive analyzers		
	► page 85	► page 84		► page 87		
						
	Single-phase	Three-phase				
	MAP 607	MAP 610	MAP 620	MAP 640	MAP 612-NI	MAP 620-NI
<b>Installation</b>						
Number of voltage channels	1	3	3	3	3	3
Number of HF voltage channels				3		
Number of current channels			4	4		4
Number of 0 – 20 mA inputs			4	4		
<b>Sampling</b>						
Sampling frequency	12.8 kHz	12.8 kHz	12.8 kHz	12.8 kHz	12.8 kHz	12.8 kHz
Frequency for fast transients				2 MHz		
<b>Communication</b>						
Mini USB	•					
CL port			•	•		
Internal Ethernet port		option	option	option	external	external
Local RS232 port		•	•	•	•	•
Remote RS232 port		•	•	•	•	•
<b>Memory</b>						
Capacity	64 MB	128 MB	128 MB	128 MB	128 MB	128 MB
<b>Internal clock</b>						
GPS synchronization via external coupler		•	•	•		
DCF synchronization via external coupler		•	•	•		
<b>Back-up power supply and connections</b>						
Internal power reserve	1 s	10 s	10 s	10 s	10 s	10 s
Power reserve via external UPS		10 mn	10 mn	10 mn	10 mn	10 mn
Voltage connections	Standardized plug	Screw-on	Screw-on	Screw-on	4 mm banana	4 mm banana
Current connections			Screw-on	Screw-on		1/4 turn (BNC type connection)
<b>Strengths</b>	Retrieval of measurements via USB 2.0 port - Plug & Play system.	Predefined reports as per EN50160. Possibility of programming a customized profile. Compliance with profile calculated in the product, thus minimizing the data to be transferred. Immediate indication of compliance with profile by LED on front panel. Possibility of managing the whole MAP600 range with the same software line.				

## ► Based on its functions

	Permanent analyzers			Non-intrusive analyzers		
	► page 85	► page 84		► pages 87		
						
	Single-phase	Three-Phase				
	MAP 607	MAP 610	MAP 620	MAP 640	MAP 612-NI	MAP 620-NI
<b>Parameters calculated</b>						
Voltage	•	•	•	•	•	•
Frequency	•	•	•	•	•	•
Unbalance	•	•	•	•	•	•
THD	•	•	•	•	•	•
Harmonics (up to 50th order)	•	•	•	•	•	•
Flicker: Pst (10 min), Plt (2 h) and LfI (inst.)	•	•	•	•	•	•
Signalling voltages	•	•	•	•	•	•
Power harmonics			•	•		•
P, Q and S power values			•	•		•
Power factors, tangents			•	•		•
<b>Voltage events</b>						
Dips	•	•	•	•	•	•
Interruption / outage	•	•	•	•	•	•
Transients	•	•	•	•	•	•
Fast variations	•	•	•	•	•	•
Event log	•	•	•	•	•	•
HF transients				•		
<b>Event capture and recording</b>						
Signature	•	•	•	•	•	•
Waveforms	•	•	•	•	•	•
Customizable power quality reports	•	•	•	•	•	•
<b>Connexion</b>						
Quick / non-intrusive connection	•				•	•
IP65 connection						
<b>Software</b>						
Qual SRT / Qual-View	•					
E.Qual-Premium		•	•	•	•	•
E.Qual-Premium-Server	• (import)	•	•	•	•	•





# Info & advice

## Power supply faults and deteriorating electrical power quality cause disturbances which adversely affect the operation of electro-technical equipment. What are the disturbances involved? What are their causes and consequences?

### SLOW VARIATIONS AND INTERRUPTIONS

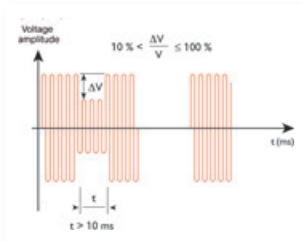

The nominal range of variation of the network voltage is set by the power distributor at  $\pm 10\%$  of the phase-to-phase voltage.

The amplitude of the voltage is usually the primary contractual commitment given by the power distributor. It is nevertheless subject to abnormal variations which may reach a level close to 0.

<b>Faults generated</b>	<ul style="list-style-type: none"> <li>▶ Voltage surge or dip</li> <li>▶ Micro-interruptions &lt; 10 ms</li> <li>▶ Short interruptions &lt; 3 min and long interruptions &gt; 3 min</li> </ul>
<b>Causes linked to disturbances due to equipments</b>	<ul style="list-style-type: none"> <li>▶ Heavy loads connected to a network whose short-circuit power at a delivery point is undersized</li> <li>▶ High-power motors, transformers and capacitor banks</li> <li>▶ Internal faults in the electrical installation</li> </ul>
<b>Causes linked to electrical power supply networks</b>	<ul style="list-style-type: none"> <li>▶ Atmospheric phenomena and accidental short-circuits</li> <li>▶ Transmission and distribution network management problems</li> </ul>
<b>Parameters to be measured</b>	<ul style="list-style-type: none"> <li>▶ Amplitude and duration of the variation</li> </ul>

### RAPID VARIATIONS

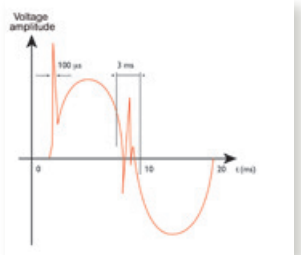

Digital analyzers with a high sampling frequency are necessary to measure transient overvoltages.

<b>Faults generated</b>	<ul style="list-style-type: none"> <li>▶ Transient overvoltages (&lt; 10 ms)</li> </ul>
<b>Causes linked to disturbances due to equipment</b>	<ul style="list-style-type: none"> <li>▶ Switching of more or less inductive loads causing transient overvoltages at high frequency</li> <li>▶ Switching of 2 thyristors causing a very brief short-circuit between the 2 phases</li> </ul>
<b>Causes linked to electrical power supply networks</b>	<ul style="list-style-type: none"> <li>▶ Atmospheric phenomena (lightning)</li> </ul>
<b>Parameters to be measured</b>	<ul style="list-style-type: none"> <li>▶ Maximum amplitude and duration of the transient</li> </ul>

### RAPID VOLTAGE VARIATIONS (FLICKER)

The discomfort caused by rapid variations in the brightness of lighting is measured by the flicker value. Effects on people: headache, irritability, epileptic fit, etc.

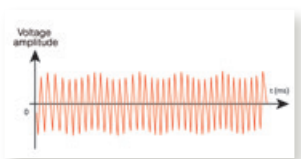

<b>Faults generated</b>	<ul style="list-style-type: none"> <li>▶ Variation of brightness</li> <li>▶ Flickering of computer screens</li> </ul>
<b>Causes linked to disturbances due to equipment</b>	<ul style="list-style-type: none"> <li>▶ Arc furnaces</li> <li>▶ Laser printers</li> <li>▶ Air-conditioning systems</li> </ul>
<b>Causes linked to electrical power supply networks</b>	<ul style="list-style-type: none"> <li>▶ None</li> </ul>
<b>Parameters to be measured</b>	<ul style="list-style-type: none"> <li>▶ Short-term flicker (Pst) and long-term flicker (Plt)</li> </ul>

### VOLTAGE UNBALANCE

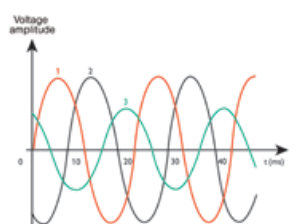

<b>Faults generated</b>	<ul style="list-style-type: none"> <li>▶ Current or voltage not phase-shifted by <math>120^\circ</math> and with different amplitudes</li> </ul>
<b>Causes linked to disturbances due to equipment</b>	<ul style="list-style-type: none"> <li>▶ Load absorbing power in an unbalanced way on the 3 phases</li> <li>▶ Disconnection of one electrical power supply phase</li> </ul>
<b>Causes linked to electrical power supply networks</b>	<ul style="list-style-type: none"> <li>▶ Disconnection of one electrical power supply phase</li> </ul>
<b>Parameters to be measured</b>	<ul style="list-style-type: none"> <li>▶ Level of unbalance, direct, inverse and homopolar voltage or current</li> </ul>

## HARMONICS AND INTERHARMONICS

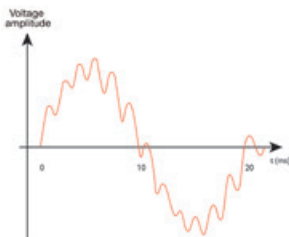

Harmonics: sinusoidal waves whose frequencies are multiples of 50 Hz superimposed on the fundamental wave.

Interharmonics: component of the signal superimposed on the fundamental wave (50 Hz) but which is not a multiple of the fundamental (e.g. 175 Hz).

The current consumed by the loads no longer has a pure sinusoidal waveform. The current distortion implies a voltage distortion that also depends on the impedance of the source.

<b>Faults generated</b>	<ul style="list-style-type: none"> <li>▶ Functional synchronization problems, switching</li> <li>▶ Untimely tripping of circuit-breakers</li> <li>▶ Induced heating reducing the life span of rotating machines, capacitors, power transformers and neutral conductors</li> </ul>
<b>Causes linked to disturbances due to equipment</b>	<ul style="list-style-type: none"> <li>▶ EQUIPMENT containing power electronics: variable speed drives, uninterruptible power supplies, dimmers, welding units</li> </ul>
<b>Causes linked to electrical power supply networks</b>	<ul style="list-style-type: none"> <li>▶ Propagation of harmonic pollution from customers supplied by the same electrical network</li> </ul>
<b>Parameters to be measured</b>	<ul style="list-style-type: none"> <li>▶ Global THD</li> <li>▶ Harmonics order by order in % and RMS value</li> </ul>

## FREQUENCY VARIATIONS

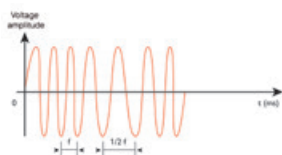

The average value of the fundamental frequency must be 50 Hz  $\pm$  1% in normal operating conditions.

Frequency fluctuations are observed on non-interconnected networks and networks connected to electrical generator sets.

<b>Faults generated</b>	<ul style="list-style-type: none"> <li>▶ Process shutdown</li> </ul>
<b>Causes linked to disturbances due to equipment</b>	<ul style="list-style-type: none"> <li>▶ Autonomous source control fault</li> </ul>
<b>Causes linked to electrical power supply networks</b>	<ul style="list-style-type: none"> <li>▶ After an overload on networks that are not interconnected or on an electrical generator set</li> </ul>
<b>Parameters to be measured</b>	<ul style="list-style-type: none"> <li>▶ Frequency F(Hz)</li> </ul>

## VOLTAGE SURGES

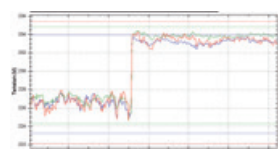

Surges of a few per cent which do not cause the voltage to deviate from the template  $\pm$  10 %.

The maximum number of voltage surges during an observation period is usually monitored.

<b>Faults generated</b>	<ul style="list-style-type: none"> <li>▶ Contributes to flicker, malfunction of the control systems acting on the phase angle, acceleration/deceleration torque of motors</li> <li>▶ Damage to sensitive electronic equipment</li> </ul>
<b>Causes linked to disturbances due to equipment</b>	<ul style="list-style-type: none"> <li>▶ Operations: motor startup, activation of a capacitor bank, activation of an inductance, etc.</li> </ul>
<b>Causes linked to electrical power supply networks</b>	<ul style="list-style-type: none"> <li>▶ Activation of load adjustment systems</li> <li>▶ Variation of production by independent producers (wind turbines, solar panels, etc.)</li> </ul>
<b>Parameters to be measured</b>	<ul style="list-style-type: none"> <li>▶ Voltage surges according to the IEC 61000-3-3 standard, difference between two stable states (voltage change less than or equal to 0.5 % for 1 second)</li> <li>▶ The characteristics of voltage surges are: duration (time between two stable states), largest voltage variation in relation to previous stable state (U<sub>max</sub>), difference between the two stable states (U<sub>stat</sub>)</li> </ul>

### FOCUS

#### Standards

For electrical power distributors, it is crucial to deliver a quality product, which means sinusoidal, balanced three-phase voltage below a rated value at a frequency of 50 Hz. It also means remaining consistent with the bill delivered to the end-user. To help distributors and users to monitor and improve electrical network quality, several standards have been drawn up.

The **EN 50160** standard defines the main characteristics of the quality of the voltage supplied by the LV and MV public distribution network at the customer delivery point: frequency, amplitude of the waveform, symmetry of the three-phase voltages during a predefined observation period.

It indicates the limits or values of the voltage specifications that any customer has a right to expect.

The **IEC 61000-4-30** standard, meanwhile, has been established to measure the various voltage quality parameters and obtain reliable, reproducible and comparable results whatever the measurement instrument used and whatever the environmental conditions. This standard defines the methods for measuring each parameter and how to interpret the results. It also stipulates the precautions necessary when installing measurement instruments on live circuits.



# MAP Range

HV / MV / LV electrical power quality analyzers – Class A

Power Quality Analyzers

## PRODUCT ADVANTAGES

- + COMPLIANT**  
with the EN 61000-4-30 standard, Class A
- + DETECTION of the fault LOCATION DIRECTION**  
(upstream/downstream) for products with current channels
- + ANALYSIS OF TRANSIENTS**  
with a high, variable sampling frequency
- + MEASUREMENT OF HARMONICS**  
(up to 50th order) and **INTERHARMONICS**  
(up to 50th group)
- + FLICKER MEASUREMENT:**  
IfI, Pst, Plt
- + PROCESSING**  
of the data according to the EN 50160 standard



Communication port: local, modem, integrated Ethernet, multi-point



Status LED: phase order and template overrun



Communication couplers: local, modem, Ethernet

## General specifications

The products in the **MAP** range, mounted on a platen or on the cabinet backplate, measure all the parameters of HV/MV/LV electrical networks: RMS voltage, frequency, THD, level of unbalance, positive/negative/zero sequence voltage, flicker, harmonics up to the 50th order, interharmonics up to the 50th group. For products with current channels: RMS current, THDI, active, reactive and apparent power,  $\cos \phi$ , power factor, power values of harmonics, energy values (calculated by the software).

The products in the **MAP** range record and, via the associated software, provide detailed, comprehensive and continuous analysis of the quality of the electricity supplied according to the applicable standards, particularly EN 50160: voltage variations (voltage dips, swells and outages), rapid variations (transient overvoltages), flicker or rapid voltage fluctuations...

Various communication modes are available for remote retrieval of the data and detailed analysis of all the parameters recorded. On some models, additional 20 mA analogue inputs can be used to:

- monitor physical parameters from a 20 mA transducer
- monitor statuses such as circuit-breaker contacts and protection relays via suitable couplers
- trigger waveform capture by a digital channel via a digital input/20 mA signal coupler
- check the equipment transmitting binary signals

# MAP 607

## Single-phase analyzer — Class A

- 2 voltage channels: phase/neutral and phase/neutral-earth
- Plug & play: no driver required
- USB 2.0 communication port
- Configuration for voltage dips, overvoltages and transient disturbances
- Class A according to IEC 61000-4-30
- Measurement of all the power quality parameters according to the predefined standard (EN 50160, etc.)
- Direct indication on the product:
  - Green LED: parameters OK
  - Red LED: parameters outside profile

## Management and analysis software

- Qual-SRT: configuration and real-time display
- Qual-view: analysis and reports



Inputs			
Voltage input (Phase-Neutral)	0-300 V RMS	Standard measurement (Class A)	1
Voltage input (Phase/Neutral-Earth)	0-300 V RMS, 700 Vpk		1
Power supply			
Power supply range		Power supply via voltage input	Yes
Internal back-up			Yes
Compliance with standards			
Sliding reference			Yes
IEC 61000-4-30, Class A	< 0.1%	Reference equipment	Yes
IEC 61000-4-7		Measurement of harmonics	Yes
IEC 61000-4-15		Flicker measurement	Yes
EN 50 160 (European Norm)		Calculated in the unit	Yes
PQDIF format			Option
Hardware			
Memory		Circular Flash Memory (NAND)	64 MB
Sampling rate			12.8 kHz (x 2)
Accuracy		Class A	< 0.1%
Resolution			16 bits
Input impedance — Input voltage			10 MΩ
Anti-aliasing filter			Yes
Bandwidth			3.5 kHz
PLL Synchronization			Yes
Communication			
USB port	2.0 (full-speed)	For PC connection, detected automatically Driver not required	Yes
Measurement specifications			
All power quality parameters are measured and stored		Voltage (avg/min/max), Frequency, THD, Harmonics (up to 50th order), Flicker (Lfl, Pst, Plt)	Yes
Analysis of rapid disturbances		Dips/swells (RMS 1/2 cycle), transients	Yes
Waveform capture		Programmable pre-time and post-time	Max. duration 200 cycles
Mechanical specifications			
Housing	For 230 V socket	Humidity: 10% - 85% without condensation	
Dimensions (L x H x D)	120 x 65 x 65 mm		
Weight	0.3 kg	Safety: EN 61 010-1	
Operating temperature	-10°C +55°C	EMC: EN 58 081-1,2; EN 50 082-1,2	

### TO ORDER

	Reference
Package includes: - MAP607 - mini USB cable - Qual-view and Qual-SRT software - carrying case	MAP607-P



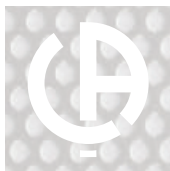

# MAP Range

## Permanent analyzers - Three-phase

▲ Power Quality Analyzers

Inputs	Specifications	Voltage		
		MAP 610	MAP 620	MAP 640
Voltage	0-275/400 VRMS, 400/690 V (option)	3	3	3
HF voltage	0-275 VRMS (6 kV), high frequency (2 MHz)	-	-	3
Current	0-6 A RMS	-	4	4
General	0-20 mA analogue inputs	-	4	4
<b>Network quality parameters</b>				
Voltage	Min, Max, average values	X	X	X
Frequency		X	X	X
Unbalance		X	X	X
Lfl, Pst and Plt flicker	Pst 10 min, Plt 2 h, Selectable storage range	X	X	X
Signalling voltages	< 3,000 Hz	X	X	X
THD-F		X	X	X
Individual harmonics	Up to 50th order	X	X	X
Interharmonics	Up to 50th group	X	X	X
Voltage surges	Number of times and variation (%)	X	X	X
Sliding reference	Complies with IEC 61000-4-30 Class A	X	X	X
<b>Other parameters</b>				
Current	Min, Max and average values	-	X	X
Current harmonics	Up to 50th order	-	X	X
Power measurement	P/Q/S, PF/cosp	-	X	X
Energy measurement in the software	active, reactive, apparent	-	X	X
<b>Event-related</b>				
Dips / overvoltages / interruptions / outages	1/2-1 cycles RMS, Class A	X	X	X
Calculation of event direction	Upstream/Downstream	-	X	X
Signature recording	12.8 kHz, half-period RMS curve	X	X	X
Pre-/post-triggering	Pre/post configurable, Pre+Post ≤ 15 s	X	X	X
Waveform recording	Configurable up to 12.8 kHz	X	X	X
Pre-/post-triggering	Pre/post configurable, Pre+Post ≤ 20 cycles	610-300	X	X
HF transients, peak detection	2 MHz	610-300	X	X
Recording of waveforms and HF transients		-	-	X
<b>Power supply</b>				
Power supply input range	85-264 Vac / 110-375 Vdc, (47-63 Hz)	X	X	X
Internal back-up		X	X	X
<b>Compliance with standards</b>				
IEC 61000-4-30, Class A	< 0.1%, reference standard	X	X	X
IEC 61000-4-7	Measurement of harmonics	X	X	X
IEC 61000-4-15	Flicker measurement	X	X	X
EN 50 160	Calculated in the equipment	X	X	X
Customized reports	Calculated in the equipment	X	X	X
PQDIF format		Option	Option	Option
<b>Hardware</b>				
Memory	128 MB Flash memory (NAND)	X	X	X
Sampling frequency		12.8 kHz	12.8 kHz	12.8 kHz / 2 MHz
Voltage accuracy		< 0.1 %	< 0.1 %	< 0.1 %
Resolution		16 bit	16 bit	16/10 bit
Standard bandwidth / HF		3.5 kHz / -	3.5 kHz / -	3.5 kHz / 1 MHz
Input impedance - voltage input		1 MΩ	1 MΩ	1 MΩ
Input impedance – current input		-	10 mΩ	10 mΩ
Anti-aliasing filter		X	X	X
<b>Communication</b>				
RS-232	PC port	X	X	X
RS-232	Modems, external couplers, etc.	X	X	X
CL port	Current loop port	X	X	X
Ethernet port (RJ-45)	Ethernet port	Option	Option	Option
<b>Mechanical specifications</b>				
Dimensions (L x H x D) in mm		160 x 240 x 60	160 x 240 x 90	160 x 240 x 90
Weight		1.3 kg	1.3 kg	1.7 kg
Operating temperature		-10°C / +50°C	-10°C / +50°C	-10°C / +50°C

TO ORDER, GO TO PAGE 88



## Non-intrusive analyzers - Three-phase

Inputs	Specifications	Voltage	Voltage / Current
		MAP 612-NI	MAP 620-NI
Voltage	275/400 VRMS, reference equipment (Class A)	3	3
Voltage range	400/690 V RMS	Option	Option
HF voltage	high frequency (2 MHz)	-	-
Current via external sensor	120 A, 1.2 kA, 1 kA flex RMS selectable	-	4*
<b>Network quality parameters</b>			
Voltage	Min, Max and average values	X	X
Frequency		X	X
Unbalance		X	X
Lfr, Pst and Plt flicker	Pst 10 min, Plt 2 h, Selectable storage range	X	X
Signalling voltages	< 3,000 Hz	X	X
THD-F		X	X
Individual harmonics	Up to 50th order	X	X
Interharmonics	Up to 50th group	X	X
Voltage surges	Number of times and variation (%)	X	X
Sliding reference	Complies with IEC 61000-4-30 Class A	X	X
<b>Other parameters</b>			
Current	Min, Max and average values	-	X
Current harmonics	Up to 50th order	-	X
Power measurement	P/Q/S, FP/cosφ	-	X
Energy measurement in the software	active, reactive, apparent	-	X
<b>Event-related</b>			
Dips / overvoltages / interruptions / outages	1/2-1 cycles RMS, Class A	X	X
Calculation of event direction	Upstream/Downstream	-	X
Signature recording	12.8 kHz, half-period RMS curve	X	X
Pre-/post-triggering	Pre/post configurable, Pre+Post ≤15 s	X	X
Waveform recording	Configurable up to 12.8 kHz	-	X
Pre-/post-triggering	Pre/post configurable, Pre+Post ≤20 cycles	-	X
HF transients, peak detection	2 MHz	-	-
Recording of waveforms and HF transients		-	-
<b>Power supply</b>			
Power supply input range	85-264 Vac, (47-63 Hz) powered on phase 1 measurement	X	X
Separate power supply input	85-264 Vac / 110-375 Vdc, (47-63 Hz)	Option	Option
Internal back-up		X	X
<b>Compliance with standards</b>			
IEC 61000-4-30, Class A	< 0.1%, reference standard	X	X
IEC 61000-4-7	Measurement of harmonics	X	X
IEC 61000-4-15	Flicker measurement	X	X
EN 50 160	Calculated in the equipment	X	X
Customized reports	Calculated in the equipment	X	X
PQDIF format		Option	Option
<b>Hardware</b>			
Memory	128 MB Flash memory (NAND)	X	X
Sampling frequency		12.8 kHz	12.8 kHz
Voltage accuracy		< 0.1 %	< 0.1 %
Resolution		16 bits	16 bits
Standard bandwidth / HF		3.5 kHz / -	3.5 kHz / -
Input impedance – voltage input		1 MΩ	1 MΩ
Input impedance – current input		-	ext. sensor
Anti-aliasing filter		X	X
<b>Communication</b>			
RS 232	PC port	X	X
RS 232	Modems, external couplers, etc.	X	X
CL Port	Current loop port	-	-
Ethernet port (RJ-45)	Ethernet port	Option	Option
<b>Mechanical specifications</b>			
Dimensions (L x H x D) in mm		160 x 240 x 60	160 x 240 x 90
IP65 casing and connections		-	-
Weight		1.3 kg	1.3 kg
Operating temperature		-10 °C / +50 °C	-10 °C / +50 °C

\* Accessory for external power supply for flex

TO ORDER, PLEASE CONTACT US





# MAP Range

Self-powered analyzer – Measurement in pole-mounted boxes

Power Quality Analyzers

MAP 620-NI in its pole-mount box with the voltage coil and the current-sensor torch



Output via leakproof connectors on the underside of the box



TO ORDER,  
PLEASE CONTACT US

## Environment

### Operating temperature:

-10°C to + 50°C

### Relative humidity:

10% - 85%, without condensation

### Installation category:

Category III, 600 V (300 V for the MAP607)

### Pollution level: 2

## Compliance with standards

### Measurements:

- EN 61000-4-30: Voltage quality measurement method (Class A RMS values)
- EN 61000-4-7: General guide to harmonic and interharmonic measurements
- EN 61000-4-15: Test and measurement technique: flickermeter

### Safety (Low Voltage Directive):

- EN 61010-1: Safety rules for electrical equipment for measurement, testing and laboratory use
- EN 60950: Safety of data processing equipment

### Communication:

- Protocol compatible with the associated Qual-SRT, E.Qual-Premium and E.Qual-Premium Server software, TCP/IP encapsulation on internal Ethernet port (option)

### Electromagnetic compatibility:

- EN 61326-1: Instructions concerning EMC for electrical measurement, control and laboratory equipment including:
  - EN 61000-4-2: Electrostatic discharge Level 3 (Air 8 kV / Contact 4 kV)
  - EN 61000-4-3: Immunity to radiated electrostatic fields – Level 3 (10 V/m)
  - EN 61000-4-4: Fast electrical transients – Level 4 (2 kV)
  - EN 61000-4-5: Immunity to voltage surges – Level 4 (common mode 2 kV, differential mode 1 kV)
  - EN 61000-4-6: Immunity to conducted disturbances – Level 3 (3 Vrms)
  - EN 61000-4-8: Level 4 (30 A/m)
  - EN 61000-4-11: Level 0 (duration 0.5 period – voltage dip and short interruption 100% U)
  - EN 61000-4-12: Level 3 (common mode 2.5 kV / diff. mode 1.0 kV)
- CISPR 16-2-1, CISPR 16-2-3, EN55011 (EN5022 required by the generic standard EN 61326)

## Mechanical specifications

### Weight:

- 1.3 kg (MAP 610, MAP612-NI, MAP 620 and MAP640)
- Mechanical shock test: EN60068-2-27: table 1: 30 g/18 m sec

### Connection:

- 4 mm<sup>2</sup> cable for U and I
- 2.5 mm<sup>2</sup> cable for inputs/outputs

## ► Electrical connections

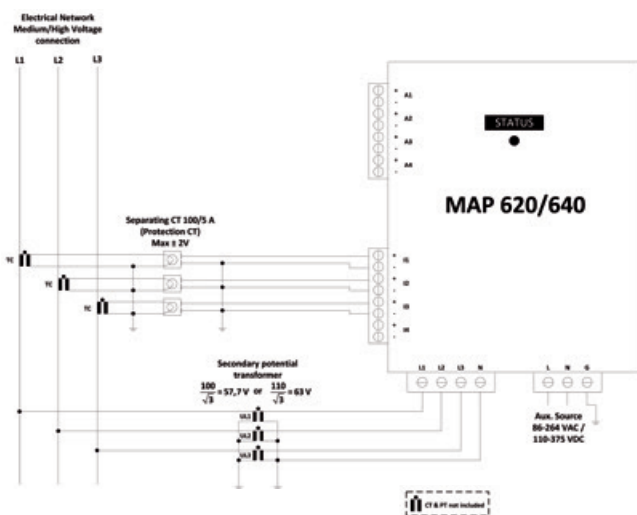
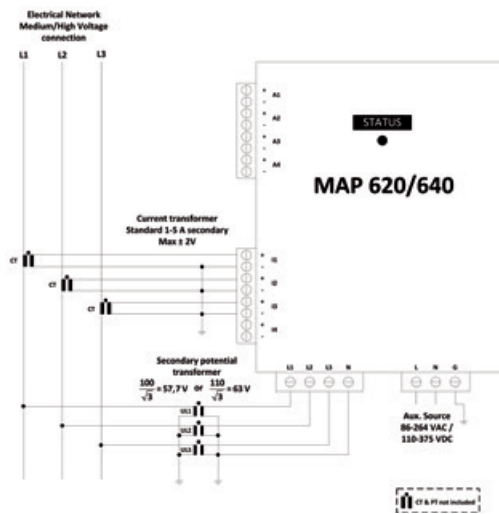
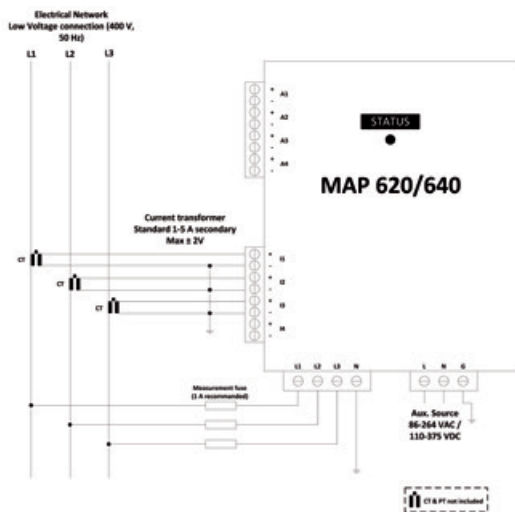

## ► Dimensions

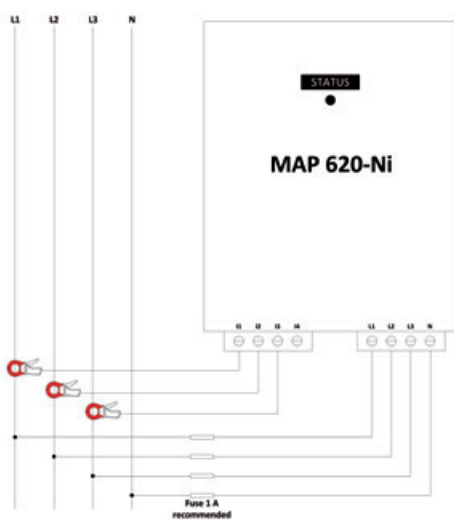
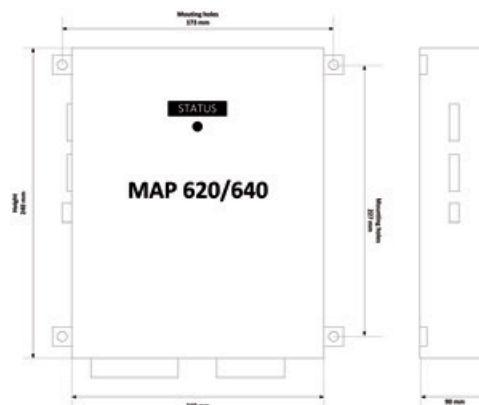



# MAP Range

Power Quality Analyzers

## ▶ Connection systems

### Permanent analyzers MAP

	MAP 610	MAP 620	MAP 640	MAP Compact
	Screw-on connectors			Screw-on connectors
Voltage				
Current	-			

### Non-intrusive MAP

MAP 612-NI / Nix	MAP 620-NI / Nix
Quick connection systems	¼ turn connection systems
612-NI 	620-NI 
612-Nix (independent power supply) 	620-Nix (independent power supply) 

### TO ORDER

	MAP6	X	0	X	X	X	X
<b>Model</b>							
1: Three-phase voltage only							
2: Three-phase voltage + Current							
4: Three-phase voltage + Current + HF transient capture							
<b>Digital outputs</b>							
-: No digital outputs							
C: Digital outputs							
<b>Communication</b>							
0: Without Ethernet port (only COM and MODEM)							
E: Without Ethernet port (+ COM and MODEM)							
<b>Power supply</b>							
0: Standard power supply (85-264 Vac / 110-375 Vdc)							
4: 48Vdc power supply							
<b>Voltage input range</b>							
0: Standard voltage input range (0-275/400 VRMS)							
6: 690 VRMS (L-L) voltage input							

Example: • **order MAP640-E40** for a MAP640 Model + Without digital outputs + Ethernet port + 48Vdc power supply  
 • **order MAP610C046** for a MAP610 Model + With digital outputs + Without Ethernet port + 48Vdc power supply + 690 VRMS voltage inputs

# MAP Compact

Compact Power Quality Analyzer— Class A with monitoring of EN50160  
template and calculation of energy values



- Built-in display
- Measurement compliant with IEC 61000-4-30 Class A
- Integrated EN50160 report generation function
- Recording of voltage dips / swells / outages
- Waveform capture with programmable pre-time and post-time
- Measurement of power and energy values as primary quantities
- Communication interfaces
- Compact format for installation in existing cabinets
- Configuration and display software: Qual-SRTc, Qual-View
- Management and analysis software: E.Qual-Premium Server

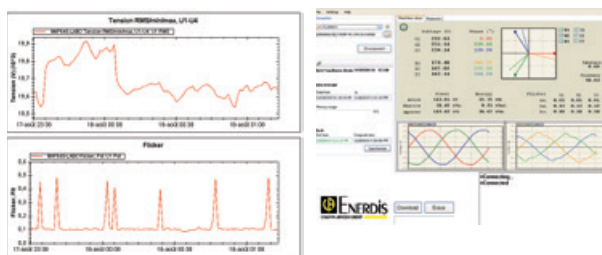

## ► Specifications

Inputs		Characteristics	
PH/N, PH/PH voltage input	3	0-364/0-630 VRMS	Impedance 1 M $\Omega$
Current input	3	0-6 A RMS	Impedance 10 m $\Omega$
CT and VT ratio	•	-	-
Sampling and algorithmic conformity			
Sampling	-	12.8 kHz / 16 bits	Anti-aliasing filter and PLL synchronization
Bandwidth	-	3.5 kHz	-
Network quality	-	IEC 61000-4-30 Class A	-
Harmonics	-	IEC 61000-4-7	50th order
Flicker	-	IEC 61000-4-15	-
Voltage surges	-	IEC 61000-3-3	-
Template monitoring	-	EN50160	-
Parameters measured			
Voltage	•	-	EN 50160
Frequency	•	-	EN 50160
Unbalance	•	-	EN 50160
Harmonics	•	-	EN 50160
Flicker (Pst, Plt, Ifl)	•	-	EN 50160
Current	•	-	10 mn
Power	•	P/Q/S, FP, cos $\phi$	Selectable integration
Energy	•	kWh, kVarh	Selectable integration
Storage, communication and display			
Mini-USB	•	-	-
CL port	•	-	-
RS232 port	•	-	-
Ethernet port	Available as an option	-	-
Storage capacity	Flash, circular	64 MB	-
Display	Navigation keys	3 lines	U, I, events
Power supply and power reserve			
Power supply	-	175 Vac to 255 Vac	-
Internal power reserve	-	10 s	-
Mechanical specifications			
Dimensions	-	155 x 165 x 68 mm	-
Weight	-	0.9 kg	-
Operating temperature	-	-10°C to +55°C	-
<b>Advantages</b>	Integrated EN50160 reports Display Measurement of network quality and energy in kWh / kVarh Compact format		

TO ORDER, PLEASE CONTACT US

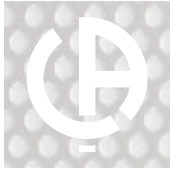

# MAP Software Range

Management and analysis software

Power Quality Software

## PRODUCT ADVANTAGES

- +** PARTICULARLY USER-FRIENDLY software
- +** ANALYSIS and DIAGNOSTICS according to the applicable standards
- +** SET-UP of all the parameters in the EN 50160 standard on A SINGLE SCREEN

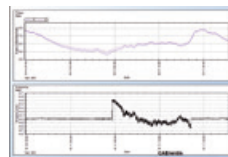

Graphic display of all the available parameters

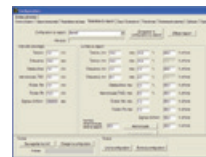

Configuration and manual or automatic retrieval of the data



Generation of reports

## ► Description

Depending on the model, the range of software for MAP allows:

- configuration of the **MAP**
- creation of call sessions
- display of the electrical parameters (monitoring mode)
- retrieval of recorded data
- analysis of the disturbances and transients
- EN 50160 analysis
- a point-to-point or client/server architecture
- an automatic data retrieval engine
- multi-equipment analysis sessions
- external synchronization by server
- an event viewer module for standby control rooms
- report printing
- transmission of alarms by e-mail, SMS, etc.

## ► Recommended configuration

PC platform  
 Operating system: Windows 2000, ME, XP  
 Processor: Pentium II  
 Frequency: 400 MHz  
 Memory: 128 MB RAM  
 Hard disk space: 70 MB

## Software for MAP 607

# Qual-SRT and Qual-View

Qual-SRT and Qual-View are dedicated software modules for the MAP607 single-phase network analyzer.

**Qual-SRT:** configuration and real-time display module for “online” display of:

- the measurements on the MAP607's two channels
- the number of dips / swells / long interruptions / short interruptions / transients recorded
- the overall status of the last EN 50160 report
- the memory occupation rate
- the equipment date and time

Dynamic views are also available: trend curve (logger-type view) and bargraph of harmonics up to the 50th order. Thanks to the ultra-fast self-declaring USB 2.0 link, this module can also be used for almost instantaneous recovery of the data and deletion of the data from the equipment.

**Qual-View:** analysis and report generation module for MAP607-type data.

This provides a view of all the trend curves generated by the equipment and includes zoom and graphic display functions concerning the limits of the power quality profile for each parameter.

Event-related views such as event signatures, waveforms and time/date-stamped event log can also be obtained using dedicated tabs in the Qual-View software. It is possible to apply a power quality profile to the measurement campaign retrieved from the MAP607.

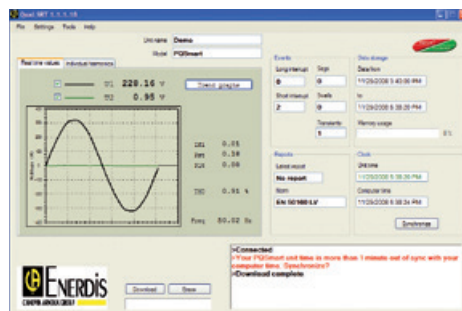

Qual-SRT: real-time display of the waveform in connection with a MAP607

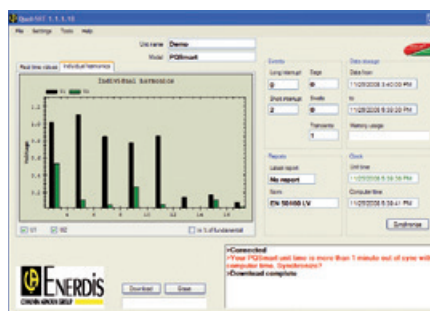

Qual-SRT: real-time display of harmonics bargraph

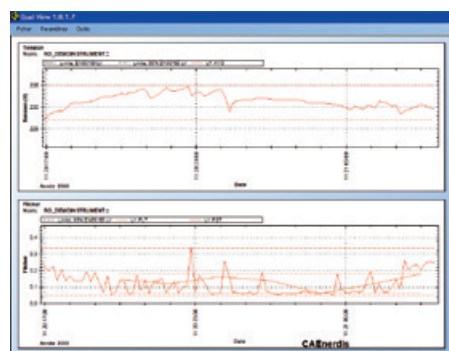

Qual-View: graphic display of the measurement campaign retrieved (trends)

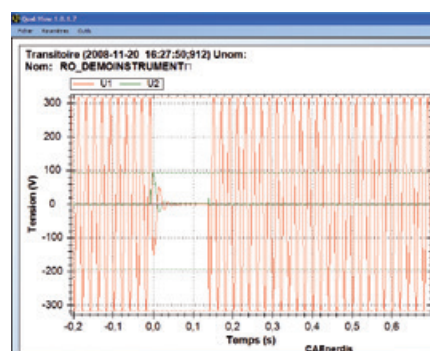

Qual-View: display of the waveform of a retrieved event (interruption)

### TO ORDER

Model	Reference
Configuration software	QUAL-SRT
Display software	QUAL-VIEW

## ► Associated products

MAP range

► page 84

Single-phase network analyzer

► page 85

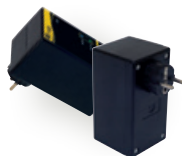





# MAP Software Range

Management and analysis software for the MAP range

Software  
 ▲ Power Quality

## E.Qual-Premium and E.Qual-Premium Server

The **E.Qual-Premium** software can be used to generate different views corresponding to the different parameters present in the measurement campaign recovered with:

- the views of the events
- the views of the transients
- the views of trend curves
- the views of the measurement campaign summaries
- the reports generated directly in MS Word® format and, in addition for the client / server version **E.Qual-Premium Server**:
- the multi-equipment graphic views
- the multi-equipment event logs
- the statistical views

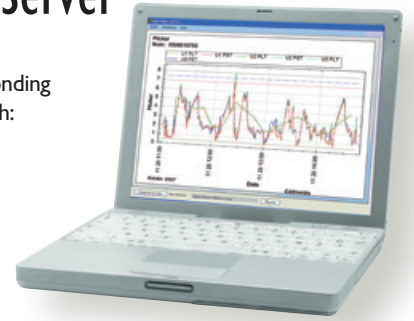

The E.Qual-Premium and E.Qual-Premium Server software modules are compatible with all the products in the MAP range.

	E.Qual-Premium	E.Qual-Premium Server5	E.Qual-Premium Server
<b>Architecture</b>			
Point to point	•	•	•
Multi-equipment by successive targeting	•	•	•
Management of measurements in database	-	•	•
Multi-site / multi-equipment	-	•	•
Client / Server architecture	-	•	•
Number of devices managed	5	5	> 5
<b>Data transfer</b>			
Manual	•	•	•
Selective transfer	•	•	•
Automatic transfer	-	•	•
Communication log	-	•	•
<b>Measurement display</b>			
Real-time waveform and vectorial	•	•	•
Recorded curves	•	•	•
Curves with multi-equipment parameters	-	•	•
Global measurement campaign	-	•	•
<b>Event display</b>			
List of events	•	•	•
Waveform and fast RMS	•	•	•
Sorted views	-	•	•
Statistical view of events	-	•	•
<b>Report generation</b>			
Standard report covering one week	•	•	•
Report covering customizable period	-	•	•

## Management and analysis software for the MAP range

	E.Qual-Premium	E.Qual-Premium Server5	E.Qual-Premium Server
<b>Architecture</b>			
Multilingual structure	•	•	•
Multi-equipment point-to-point by successive targeting	•	•	•
Number of devices managed	5	5	> 5
Licence for managing additional equipment	•	-	•
Measurement management in file mode	•	•	•
Measurement management in SQL Server database	-	•	•
Multi-site / multi-equipment	-	•	•
Client / Server and single-station Client / Server architecture	-	•	•
Possibility of remote clients	-	•	•
<b>Data transfer and type</b>			
Manual transfer	•	•	•
Automatic transfer	-	•	•
Selective transfer between start date and end date	•	•	•
Transfer of average, minimum and maximum values	•	•	•
Transfer of harmonics and interharmonics order by order	•	•	•
Transfer of frequencies	•	•	•
Transfer of summarized events	•	•	•
Transfer of half-period RMS curve signatures	•	•	•
Transfer of waveforms	•	•	•
Transfer of EN50160 reports and customized profiles	•	•	•
<b>Real-time display</b>			
Measurement time period	•	•	•
Voltage / current / power values / unbalance / frequency	•	•	•
Dip / swell / transient counter	•	•	•
Macroscopic status of internal power quality report	•	•	•
U/I waveforms and Fresnel vector	•	•	•
THD U / THD I	•	•	•
Individual harmonics up to 50th order	•	•	•
Bargraph of U/I harmonics up to 50th order	•	•	•
Flicker indicator: LfI, Pst, Plt	•	•	•
<b>Configuration</b>			
CT / VT ratios	•	•	•
Storage intervals	•	•	•
Max / min limits of profile	•	•	•
Statistical integration (X%) for each parameter	•	•	•
Limit for dips / swells	•	•	•
Pre-time and post-time for RMS signature and waveform	•	•	•
Limit for transients	•	•	•
Pre-time and post-time for transients	•	•	•
Alarm events	•	•	•
SMS alarms	•	•	•
Unit, scale factor and offset for general inputs	•	•	•
Triggering on digital channels	option	option	option
<b>Measurement campaign analysis</b>			
Graph of average values	•	•	•
Superimposing of half-period min / max envelope	•	•	•
Superimposing of min/max limit reached	•	•	•
Superimposing of power quality profile min/max limit	•	•	•
Multi-curve / multi-parameter graph	•	•	•
Zoom in / out	•	•	•
Synchronized zoom on several curves	•	•	•
Synchronized displacement of several curves	•	•	•

	E.Qual-Premium	E.Qual-Premium Server5	E.Qual-Premium Server
<b>Analysis of events</b>			
Filtered lists of summarized events	•	•	•
Detailed view of event parameters	•	•	•
Fast RMS envelope event view	•	•	•
Graphic overlay of U/I envelope	•	•	•
Fast RMS envelope view displacement	•	•	•
Event waveform view	•	•	•
Superimposing of U/I waveform	•	•	•
Zoom in / out	•	•	•
Waveform view displacement	•	•	•
Event	•	•	•
<b>Functions on the views</b>			
Graphic copy in clipboard	•	•	•
Graphic recording on hard disk	•	•	•
Configuration of graph axis scales	•	•	•
Graphic printing configuration	•	•	•
Graphic printing	•	•	•
<b>Report generation</b>			
Standard report generation	•	•	•
Customized report generation	•	•	•
One-week report generation	•	•	•
Customizable-period report generation	option	•	•
<b>Multi-site / multi-equipment mode</b>			
Regional multi-base data source	-	•	•
Possibility of inserting retrieved file in base	-	•	•
Multi-parameter / multi-equipment graphics	-	•	•
Summarized multi-equipment event impact view	-	•	•
Multi-equipment list of summarized events	-	•	•
Interactive viewer: list / summarized view / detailed view	-	•	•
Multi-equipment event list sorting	-	•	•
Filtered multi-equipment summarized event list	-	•	•
Advanced event list filter	-	•	•
Event CSV export	-	•	•
Multi-equipment communication log	-	•	•
ITIC statistical viewer	-	•	•
SEMI47 statistical viewer	-	•	•
UNPEDE table statistical viewer	-	•	•
Measurement campaign Excel export	-	•	•
Measurement campaign PQDIF export	-	option	option
Overview of energy values in selectable interval	-	•	•
CSV export of energy values	-	•	•
<b>Administration of automatic remote retrieval</b>			
Frequency of automatic remote retrieval	-	•	•
Frequency: never/immediate/10 min / hour / day / week	-	•	•
Normal transfer / all data / with harmonics	-	•	•
Possibility of automatic deletion after retrieval	-	•	•
Automatic remote retrieval start date / time	-	•	•
Communication for remote retrieval for each device	-	•	•



# MAP Software Range

Management and analysis software for the MAP range

Power Quality Software

## ► General specifications

### Parameters according to EN 50160

- Network frequency
- Power supply voltage
- Slow and rapid voltage variations
- Short and long outages
- Voltage dips and asymmetries
- Harmonic and interharmonic voltages
- 50 Hz transient overvoltages

### Flicker

- Flicker measurement according to EN 61000-4-15: short-term flicker (Pst), long-term flicker (Plt)

### Voltage and current

- TRMS value and average value
- Peak value and crest factor

### Power / Energy values

- Active power produced and consumed
- Inductive or capacitive reactive power
- Apparent power, power factor and  $\cos \varphi$
- Active energy produced and consumed
- Inductive or capacitive reactive energy
- Apparent energy

### Harmonic breakdown up to 50<sup>th</sup> order

- Harmonics: current, voltage, power in relation to the fundamental and in absolute terms
- Phase shift of each harmonic order
- Global THD global and order by order
- Recognition of the direction of each harmonic order

### Analysis of three-phase system unbalance

- Measurement of a system's symmetry: positive, negative, zero sequence components
- Phase shift
- Vectorial representation of voltage and current

### Analysis on networks

- Recording of "short-circuit" events (faultograph function)
- Location of the fault, duration of the phenomenon
- Analysis of the network impedance
- Analysis of remote control signals: definition and verification of the frame
- Verification of equipment operation (capacitors, filters, circuit-breakers)

## ► Dip / overvoltage / interruption / outage events

After retrieving the data recorded by the MAP network analyzers, the dip/overvoltage/interruption/outage events captured when outside the programmed profile can be displayed in different views available in the E.Qual-Premium software. The zoom function can be used on the views.

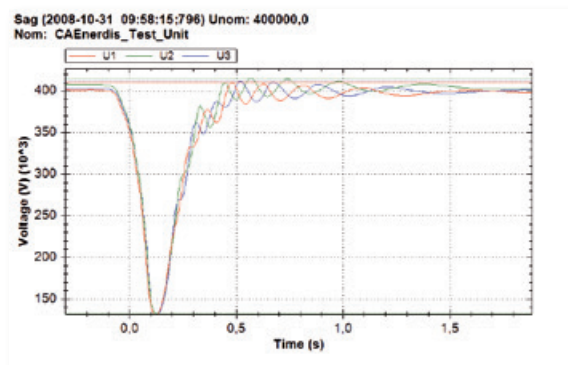

View of the signature curve of a voltage dip, obtained using the fast RMS values refreshed every half-period. The pre-time and post-time for recording are those programmed in the MAP network analyzer.

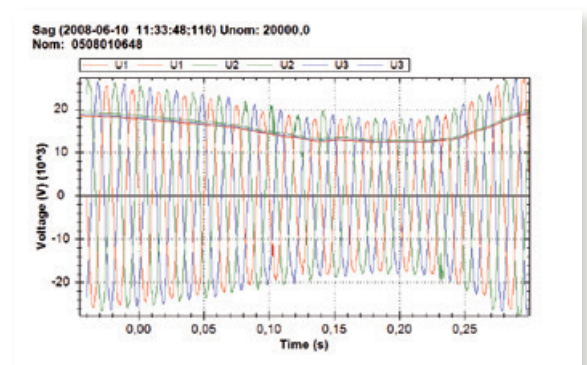

View of the signature curve of a voltage dip superimposed with the waveforms of the real signals on the three phases. The waveforms are displayed with a high resolution matching the sampling rate, i.e. 12,800 Hz. The event-related view is given directly in the primary quantity, taking into account the CT and VT transformation ratios of the substation where the measurements were taken.

## Management and analysis software for the MAP range

### ► Subcyclic transients

With the fast transient capture mode, transient events can be viewed with a resolution of 12.8 KHz or 2 MHz, depending on the MAP model. The detection templates are in positive and/or negative dV/dT.

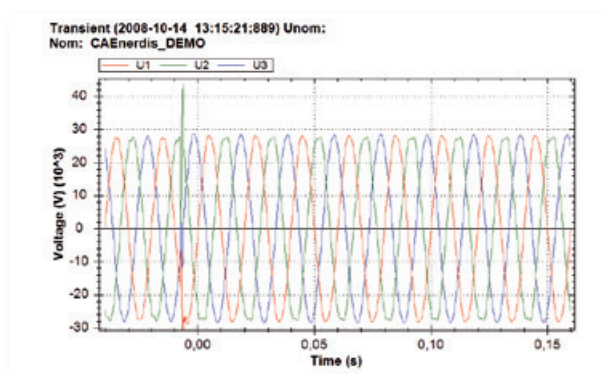

Three-phase view of a fast transient affecting the network's phases.

### ► Trend curves of the parameters recorded by the MAPs

The E.Qual-Premium software can manage a large number of trend curves. After retrieval the curves containing all the parameters covered by the EN 50160 standard, as well as the power values, power factors and Cos  $\varphi$  can be viewed and zoomed on.

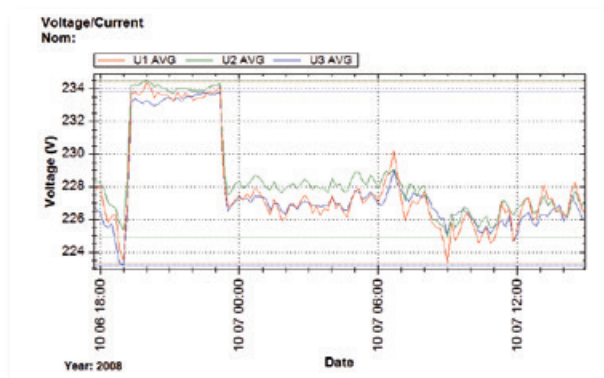

View of the trend curves of the three-phase voltages during a MAP measurement campaign, as analysed by the graphic module of the E.Qual-Premium software.

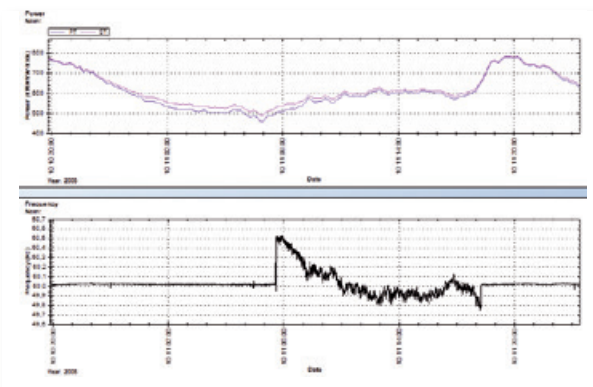

Stacked view of two different graphs from the same measurement campaign. The E.Qual-Premium software allows you to stack as many curves as you wish.

### ► Summary of the measurement campaign

Category	Subcategory	Start	End	Count
Voltage	Line-to-line	2/10/2008 10:44:00	5/10/2008 13:00:00	20
	Line-to-neutral, U1-U2	2/10/2008 10:44:00	5/10/2008 13:00:00	20
	Line-to-neutral, U1-U3	2/10/2008 10:44:00	5/10/2008 13:00:00	20
	Line-to-neutral, U2-U3	2/10/2008 10:44:00	5/10/2008 13:00:00	20
	Phase U1	2/10/2008 10:44:00	5/10/2008 13:00:00	20
	Phase U2	2/10/2008 10:44:00	5/10/2008 13:00:00	20
	Phase U3	2/10/2008 10:44:00	5/10/2008 13:00:00	20
	Line-to-neutral, U1-U2	2/10/2008 10:44:00	5/10/2008 13:00:00	20
	Line-to-neutral, U1-U3	2/10/2008 10:44:00	5/10/2008 13:00:00	20
	Line-to-neutral, U2-U3	2/10/2008 10:44:00	5/10/2008 13:00:00	20
Current	Line-to-line	2/10/2008 10:44:00	5/10/2008 13:00:00	20
	Line-to-neutral, I1-I2	2/10/2008 10:44:00	5/10/2008 13:00:00	20
	Line-to-neutral, I1-I3	2/10/2008 10:44:00	5/10/2008 13:00:00	20
	Line-to-neutral, I2-I3	2/10/2008 10:44:00	5/10/2008 13:00:00	20
	Phase I1	2/10/2008 10:44:00	5/10/2008 13:00:00	20
	Phase I2	2/10/2008 10:44:00	5/10/2008 13:00:00	20
	Phase I3	2/10/2008 10:44:00	5/10/2008 13:00:00	20
	Line-to-neutral, I1-I2	2/10/2008 10:44:00	5/10/2008 13:00:00	20
	Line-to-neutral, I1-I3	2/10/2008 10:44:00	5/10/2008 13:00:00	20
	Line-to-neutral, I2-I3	2/10/2008 10:44:00	5/10/2008 13:00:00	20

View of the summary of the measurement campaign with the time periods present for each type of parameter.

### ► Power Quality report view

Report: EN 50160 LV	
<b>Site information</b>	
Test site:	MAP040-Lab
Measured voltage:	230 V
Measuring unit ID#:	000000020
Measuring unit model:	MAP040
Measuring unit accuracy:	< 0.1%
Transformer accuracy:	
Reference:	Chapter
<b>Report information</b>	
Date:	2008-09-01 12:37:36
Card name:	EN 50160 LV

View of preformatted or customized reports generated directly in MS Word® format. It is possible to create new report models which will then be added to the existing report model library.



# MAP Software Range

Management and analysis software for the MAP range

Software  
Power Quality

## E.Qual-Premium Server

The client/server version of the E.Qual-Premium Server software provides a multi-equipment, multi-parameter view of the measurements recovered by the automatic remote retrieval engine. It is then possible to put together totally customized views by “dragging and dropping” the parameters of different equipment items into the display area. Summarized and statistical views are also available.

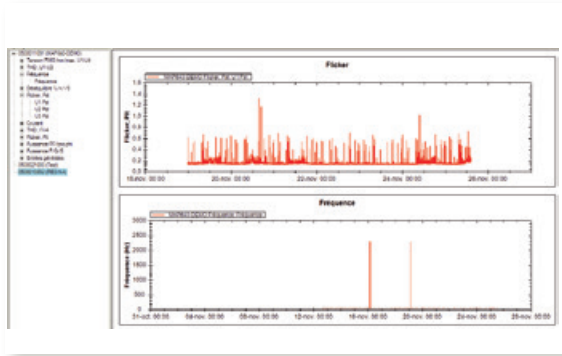

Multi-equipment view with the client/server version of E.Qual-Premium. The parameters featuring in the view are chosen in the equipment / parameters / phases tree structure located on the left-hand side of the analysis window.

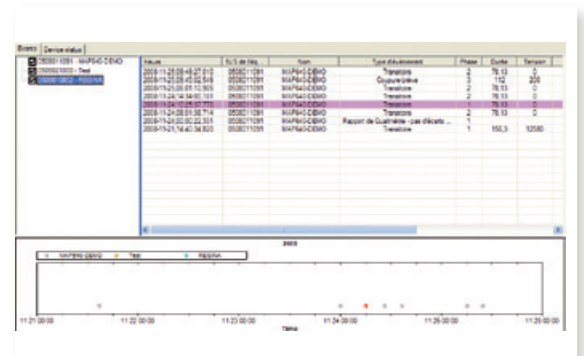

Multi-equipment log view of the dip / overvoltage / interruption / outage events. A summarized view shows the occurrence times of all the events recovered by the automatic remote retrieval engine. When you select an event in the list, the same event is automatically highlighted in the summarized view. You can open the RMS / waveform signature view by double-clicking on the event.

- ▶ Statistical views of the impacts of dips / overvoltages / interruptions and outages compared with standardized templates such as the ITI profile, SEMI 47 and UNIPEDE table.

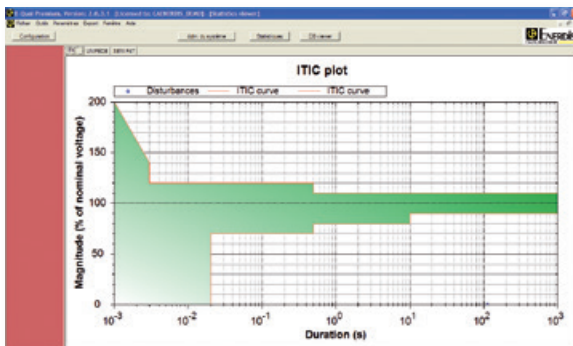

Statistical view of the dip / overvoltage / interruption / outage events compared with the ITI template

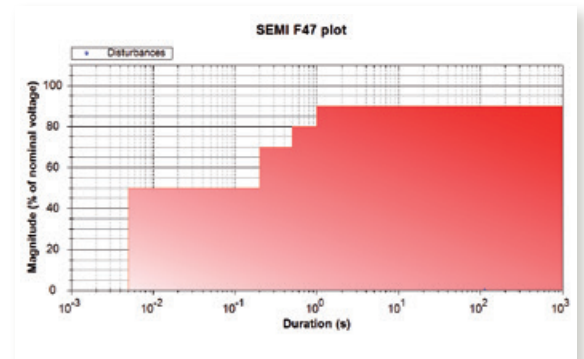

Statistical view of the dip / overvoltage / interruption / outage events compared with the SEMI 47 template.



## Management and analysis software for the MAP range

# E.Qual-Premium Server architecture

The E.Qual-Premium Server architecture is ideal for applications where you want to analyse the energy quality measurements gathered from several points in the electrical network and compile data supplied by different models in the MAP range. Thanks to its automatic remote retrieval engine, the E.Qual-Premium Server software is capable of transferring the data from the different network analyzers and integrating them into the system's SQL-server® base. The multi-equipment analysis module can then use the measurements stored in the database to generate composite views and statistics grouping information from several measurement points.

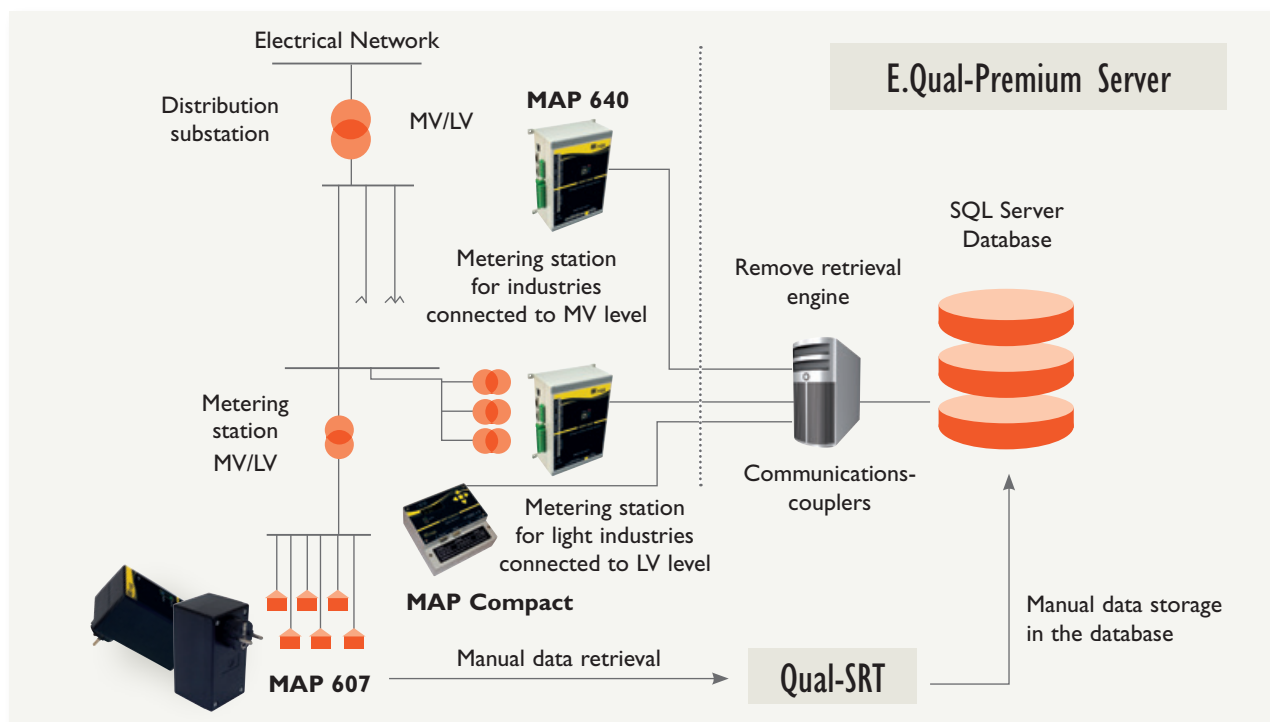

Components of an E.Qual-Premium Server with the network analyzers, the communication links, the database and the analysis and graphic display modules.

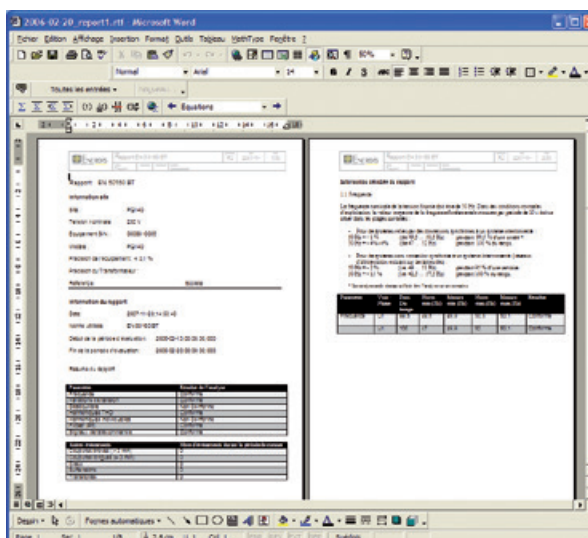
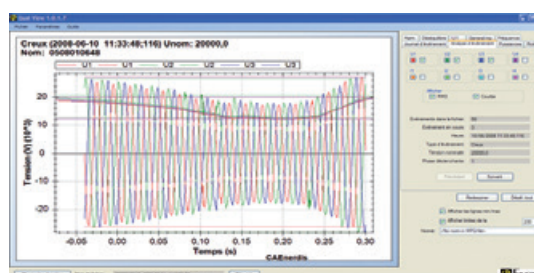
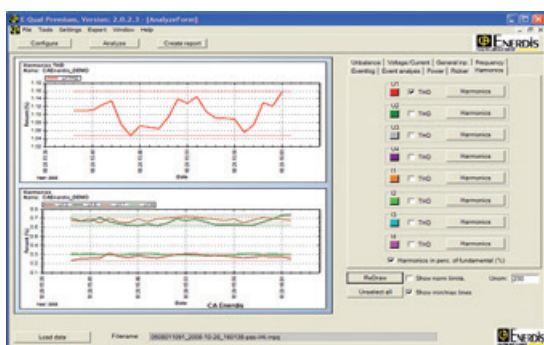





# Audit and Troubleshooting Department

Engineers ready to listen and support any approach for electrical network optimization.

Service  
Power Quality

## PRODUCT ADVANTAGES

- + A **DEDICATED TEAM** to support your project
- + **CUSTOMIZED AUDITS** based on your specifications
- + Targeted studies **FROM DOWNSTREAM OF THE MV/LV TRANSFORMER THROUGH TO YOUR TERMINAL DISTRIBUTION SYSTEM**



Enerdis uses Chauvin Arnoux® and Metrix® instruments for its troubleshooting activities

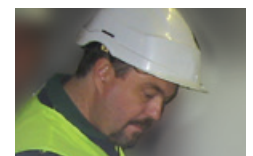

Experts carry out a totally customized study

## ► Description

The specialized engineers comprising the **ENERDIS TROUBLESHOOTING DEPARTMENT** propose electrical network auditing services. The goal is to help you identify the main features of your industrial, tertiary and infrastructure networks.

**Analysis** of the parameters liable to cause malfunctions or excessive loads on the installations.

**Recommendation** of solutions to meet the energy quality requirements.

Power supply faults and deterioration of electrical power supply quality cause disturbances whose cost is a major concern for industrial companies. Prevention is the best strategy for dealing with harmonic distortion, outages, voltage variations and transient phenomena.

### Consequences of harmonic currents on the network

Often underestimated, harmonic currents cause problems at the level of both the distribution system and the installation:

- overheating of the neutral
- overheating of the transformers
- untimely tripping of protective devices
- overloading of capacitors
- skin effect in the conductors

The Enerdis Audit and Troubleshooting Department helps you to gain a better understanding of your electrical network and supports you in your search for suitable solutions.

### Power quality

- Measurement of the energy quality parameters and compliance with the levels required by the EN 50160 standard
- Evaluation of the parameters outside the template and analysis of the danger for equipment and loads downstreams
- Evaluation of the interconnection parameters over several integration periods for measurement periods of up to one week

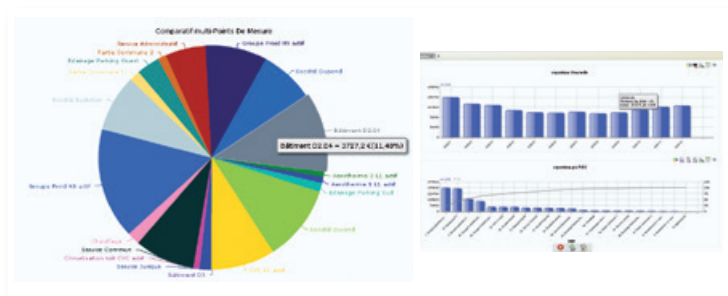

### Study of the need for Power Factor Correction

- Evaluation of the power factor ( $\cos \phi$ ) with activation of different types of loads
- Study of the need for Power Factor Correction to avoid penalties during the period of reference
- Recommendations for capacitor bank sizing: type of fixed/regulated compensation, standard type of reinforcement, H or SAH



### Study of harmonic pollution

- Measurement of harmonic pollution and evaluation at different points in the electrical distribution system
- Correlation with the activation of loads causing disturbances
- Global survey of harmonic pollution over a cycle representative of the site's load profile
- Recommendation of filtering solutions

### Study of load profile

- Global energy survey of the site with study of the power components over a significant load period
- Evaluation of the load on the site's MV/LV transformers and possible overloading
- Evaluation of the load profile observed and the threshold effects on the tariff contract

### Study of common-mode components

- Measurement of the common-mode currents liable to cause untimely tripping of CBs
- Measurement of the common-mode voltages liable to cause malfunctioning of sensitive downstream loads

### Customized audits

In the context of the TROUBLESHOOTING activity, a made-to-measure audit can be performed. Our experts carry out a customized survey of the different technical points stipulated in your specifications.

#### Work method: keeping as close as possible to the statement of requirements

- Contact to assess the precise requirements in a partnership between the customer and ENERDIS
- Drafting of a customized technical and sales offer
- Definition of a work schedule and the work method proposed
- Troubleshooting inspection by experienced staff with all the necessary electrical authorizations needed for on-site measurement work
- Instrumentation of the measurement points defined in the troubleshooting work method and recording of relevant measurements
- Generation of a troubleshooting report with recommendations



# Current transformers (CTs) &

▶ Measurement and instrumentation

## Standard industrial transformers

TCR  
Wound primary  
▶ page 113



TCR  
Cable/busbar primary  
▶ page 114



TCR  
Busbar primary  
▶ page 117



TCRO  
Split core  
▶ page 118



TC CLIP  
Split core  
▶ page 121



## Adaptable industrial transformers

JVR  
Wound primary  
▶ page 124



JVO  
Cable primary  
▶ page 125



JVO  
Cable/busbar primary  
▶ page 126



JVP  
Busbar primary  
▶ page 128



## Transformers for energy metering

JVS  
Cable/busbar primary  
▶ page 130



JVS  
Busbar primary  
▶ page 132



# shunts

## Transformers for price metering

### Single-phase, single-rating

JVP 1045B  
▶ page 134



JVO 40-100  
▶ page 135



### Single-phase, multi-rating

JVO 40-100S  
▶ page 136



JVO 90-160S  
▶ page 137



JVS 1145S  
▶ page 138



### Three-phase, single-rating

TRI 500  
▶ page 139



### Three-phase, multi-rating

TRI 700  
▶ page 140



## Current summation

JVM 15  
▶ page 141



## Associated product

PRTC  
CT short-circuiting switch  
▶ page 142



## Shunts

### Class 0.5

76/2 – 77/2 range  
▶ page 145

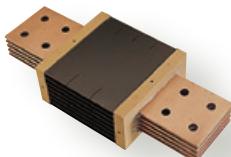

SHMO range  
DIN rail mounting  
▶ page 150



### Class 1

SHMI range  
▶ page 147

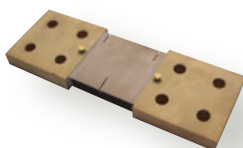

SHEL range  
▶ page 149





# Choosing your **standard industrial**

Choosing your **adaptable** industrial current transformer: page 106  
 Choosing your transformer **for energy metering**: page 108

## Current transformers (CTs)

### Measurement and instrumentation



TCR Wound primary				TCR Cable/busbar primary						
▶ page 113				▶ page 114						
	TCR 10	TCR 11	TCR 15	TCR 21	TCR 31	TCR 41	TCR 51	TCR 61	TCR 71	TCR 75
Wound primary (threaded rod)	aperture 25 x 25	Ø M6	wire 16 mm <sup>2</sup>							
Cable primary (mm)				Ø 20	Ø 22	Ø 26	Ø 28	Ø 44	Ø 63	
Busbar primary (mm)				15 x 10 20 x 10 25 x 5	20 x 12 25 x 11 30 x 10	20 x 20 25 x 12 30 x 10	20 x 25 30 x 15 40 x 10	50 x 30 60 x 12	50 x 50 60 x 37 80 x 30	3 x 100 x 10
Primary	5 A									
	10 A									
	15 A									
	20 A									
	25 A									
	30 A									
	40 A									
	50 A									
	60 A									
	75 A									
	100 A									
	125 A									
	150 A									
	200 A									
	250 A									
	300 A									
	400 A									
	500 A									
	600 A									
	750 A									
	800 A									
	1000 A									
	1200 A									
	1500 A									
	2000 A									
	2500 A									
	3000 A									
	4000 A									
	5000 A									
<b>Strengths</b>	Combining a high level of accuracy and compact design.			Come in a wide range of primaries. Mounting accessories supplied as standard.						

5 A or 1 A secondary as standard

5 A secondary as standard  
1 A on request

5 A secondary only

# current transformer

TCR Busbar primary			TCRO Split core					TC CLIP Split core				
▶ page 117			▶ page 118					▶ page 121				
												
TCR 80	TCR 90	TCR 100	TCRO 2030	TCRO 5080	TCRO 8080	TCRO 80120	TCRO 80160	TCC 176	TCC 241	TCC 242	TCC 364	TCC 366
								Ø 17	Ø 24	Ø 24	Ø 36	Ø 36
100 x 20	100 x 30	1025 x 60	20 x 30	50 x 80	80 x 80	80 x 120	80 x 160					
Complete products for 100 and 125 mm busbar type.			A wide range suitable for most primaries. Installation without disconnecting busbars.					Implementation without disconnecting the power cables. Compact format.				







# Choosing your **adaptable industrial**

Choosing your **standard** industrial current transformer: page 104

Choosing your transformer **for energy metering**: page 108



## Current transformers (CTs)

### Measurement and instrumentation

	JVR Wound primary			JVO Cable primary						
	▶ page 124			▶ page 125						
										
	JVR 64	JVR 75	JVR 86	JVO 12-46	JVO 18-51	JVO 21-64	JVO 21-75	JVO 32-75	JVO 36-75	J3R 80 B
Wound primary (threaded rod)	M8	M8 - M10	M8 - M10							
Cable primary (mm)				Ø 12	Ø 18	Ø 21	Ø 21	Ø 32	Ø 36	Ø 66
Busbar primary (mm)										
Primary	5 A									
	10 A									
	15 A									
	20 A									
	25 A									
	30 A									
	40 A									
	50 A									
	60 A									
	75 A									
	100 A									
	125 A									
	150 A									
	200 A									
	250 A									
	300 A									
	400 A									
	500 A									
	600 A									
	750 A									
	800 A									
	1000 A									
	1200 A									
	1250 A									
	1500 A									
	2000 A									
	2500 A									
	3000 A									
<b>Strengths</b>	Primary connection via threaded rod for more compact size.			A wide choice of primaries.						
	<b>SPECIFIC PRODUCTS POSSIBLE IN THIS RANGE</b>									

5 A secondary as standard / 1 A on request

# current transformer

JVO Cable/busbar primary		JVP Busbar primary		
▶ page 126		▶ page 128		
				
JVO 25 CR	JVO 32 CR	JVP 624	JVP 1025	JVP 1045
32.5 x 10.5	40.5 x 10.5	65 x 22	105 x 22	105 x 42
JVO version for cable or busbar primary.	A wide choice of busbars from 60 to 100 mm.			
<b>SPECIFIC PRODUCTS POSSIBLE IN THIS RANGE</b>				



# Choosing your current transformer for

Choosing your **standard** industrial current transformer: page 104

Choosing your **adaptable** industrial current transformer: page 106

▲ Measurement and instrumentation Current transformers (CTs)

JVS Cable/busbar primary
JVS Busbar primary

▶ page 130



▶ page 132









		JVS 25B	JVS 26B	JVS 30B	JVS 38B	JVS 39B	JVS 40	JVS 50	JVS 60
Cable primary (mm)		Ø 26	Ø 28	Ø 44	Ø 63				
Busbar primary (mm)		20 x 20 25 x 12 30 x 10	20 x 25 30 x 15 40 x 10	50 x 30 60 x 12	50 x 50 60 x 30 80 x 30	3 x 100 x 10	100 x 20	100 x 30	125 x 60
Primary	100 A								
	150 A								
	200 A								
	250 A								
	300 A								
	400 A								
	500 A								
	600 A								
	750 A								
	800 A								
	1000 A								
	1200 A								
	1500 A								
	2000 A								
2500 A									
3000 A									
4000 A									
5000 A									
<b>Strengths</b>		High-accuracy range with very low phase shift, ideal for electronic measurement instruments, including energy metering							

5 A secondary as standard

5 A secondary as standard with individual test certificate

1 A secondary with individual test certificate on request

# energy and price metering

	Single-phase single-rating		Single-phase multi-rating			Three-phase single-rating	Three-phase multi-rating			
	▶ pages 134-135		▶ pages 136-137-138			▶ page 139	▶ page 140			
										
	<b>JVP 1045 B</b>	<b>JVO 40-100</b>	<b>JVO 40-100 S bi-rating</b>	<b>JVO 90-160 S tri-rating</b>	<b>JVS 1145 S tri-rating</b>	<b>TRI 500</b>	<b>TRI 700 S 50-100/5 A</b>	<b>TRI 700 S 100-200/5 A</b>	<b>TRI 700 S 200-500/5 A</b>	<b>TRI 700 100-200- 500/5 A</b>
Accuracy class (according to EN 60044-1)	0.5	0.5	0.2s	0.2s	0.2s	0.5	0.2s	0.2s	0.2s	0.5
Cable primary (diameter in mm)		Ø 42 mm	Ø 40 mm	Ø 90 mm	Ø 40 mm					
Busbar primary (mm)	100 x 40				63 x 12 100 x 12					
Cable clamp (section in mm <sup>2</sup> )						22 to 240 mm <sup>2</sup>	50 to 240 mm <sup>2</sup>	50 to 240 mm <sup>2</sup>	50 to 240 mm <sup>2</sup>	50 to 240 mm <sup>2</sup>
Primary (secondary 5 A)	50 A									
	100 A									
	150 A									
	200 A									
	300 A									
	500 A									
	1000 A									
	2000 A									

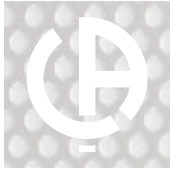

# Info & advice

## TRANSFORMERS

### Function

Current transformers power low-voltage measuring instruments and isolate them from the network. They supply their secondary winding with a standard current proportional to the primary current. They are divided into four main families:

- wound primaries;
- split-core primaries;
- cable primaries;
- busbar primaries.

These transformers can be used with all types of measuring instruments: ammeters, energy meters, power monitors, etc.

### How to choose a current transformer?

The choice is based on two main criteria:

- the current on the primary (transformation ratio  $I_p / 5 A$ );
- the type of installation.

In other words, the choice **depends on the type of cable or busbar** on the installation and the **intensity of the currents flowing through them**.

### Determining a CT's accuracy class

The accuracy class of a current transformer depends on the transformer's apparent power (VA) and the consumption of the entire measurement line. It is the result of the measurement errors of each element in the line and must therefore be less than or equal to the accuracy class of the measuring instrument which it supplies, particularly for energy metering where accuracy has a direct impact on billing. For a given accuracy class, the measurement line's consumption must not exceed the current transformer's apparent power (VA).

### Example of measurement chain consumption at 20 °C

Copper-wire section (mm <sup>2</sup> )	Power dissipated per metre of line (2 ways)	
	Secondary 5 A	Secondary 1 A
1.5	0.61	0.025 VA
2.5	0.37	0.015 VA
4	0.23	0.009 VA
6	0.15	0.006 VA
<b>Enerium 50 Power Monitor</b>		
	0.15 VA	
5 m of double 2.5 mm <sup>2</sup> wire		
	0.37 x 5 = 1.85 VA	
<b>Measurement line consumption</b>		
	0.15 + 1.85 = 2 VA	

The transformer's accuracy class can then be deduced from the results obtained by referring to the table opposite (provided as an example):

- Class 3 for a CT with a ratio of 150/5
- Class 1 for a CT with a ratio of 200/5
- Class 0.5 for a CT with a ratio of 250/5

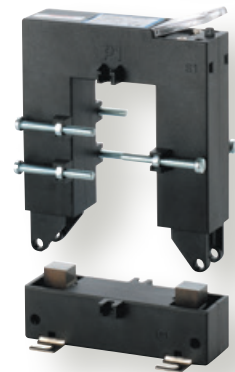

Primary	Power (VA) on Class		
	0.5	1	3
100 A	-	1	1.5
125 A	-	1	1.5
150 A	1	1.75	2.5
200 A	1.5	2.75	3.75
250 A	2	3.25	3.75
300 A	2.5	3.25	4
400 A	3	3.75	5
500 A	3.5	3.75	5
600 A	3.75	5	7.5

## SELECTING A TRANSFORMER

Enerdis current transformers offer 4 types of connection:

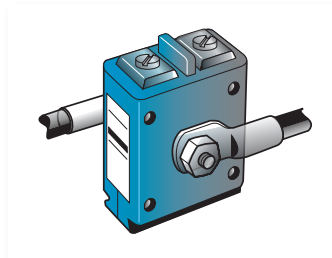

**WOUND PRIMARY**  
for currents less than 200 A

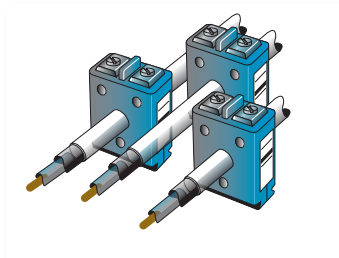

**CABLE PRIMARY**  
for currents between 40 and 2,500 A

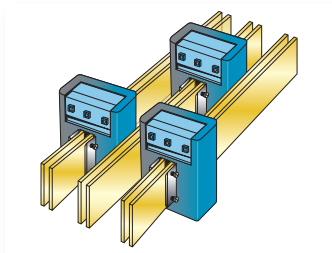

**BUSBAR PRIMARY**  
for currents between 750 and 5,000 A

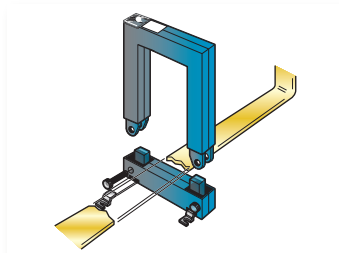

**SPLIT CORE PRIMARY**  
for easy connection to an existing installation  
using a busbar or cable primary

## CONNECTING YOUR CT

It is important to always install the transformer in the right direction, especially on three-phase networks, so as not to invert the phase shift between the current and the voltage on one or more of the phases.

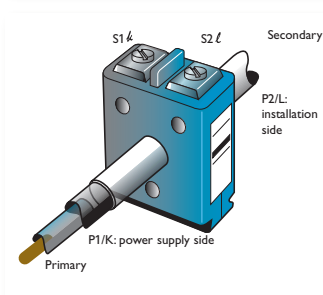
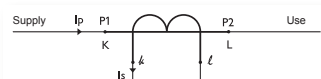

## Accuracy limit tables according to the IEC 60044-1 standard

Class	Limit errors – Table 1			
	± Error (in %) depending on In (in %)			
	5	20	100	120
0.2	0.75	0.35	0.20	0.20
0.5	1.50	0.75	0.50	0.50
1	3.00	1.50	1.00	1.00

Class	Limit errors – Table 2				
	± Error (in %) depending on In (in %)				
	1	5	20	100	120
0.2 S	0.75	0.35	0.20	0.20	0.20
0.5 S	1.50	0.75	0.50	0.50	0.50

### FOCUS

#### Financial impact of a TC's accuracy class

For a consumption of 12,000 MWh/year and a cost of € 0.10/kWh

- CT class 1: ±120,000 kWh = ±€ 12,000
- CT class 0.5: ±60,000 kWh = ±€ 6,000
- CT class 0.2S: ±2,500 kWh = ±€ 2,500

This calculation takes into account neither the class of the measuring instruments, nor loss occurring on the network cables.

#### CT safety rules

You must never open the secondary circuit of a CT supplied on the primary. The very high voltage created may cause bodily harm or irreparable damage to the transformer.

Before working on the secondary of a CT, it must be short-circuited.

When a CT is not in use (secondary open) the secondary must be short-circuited before powering up the system.





# TCR Range

CTs designed for submetering. Accuracy class 0.5/1/3

Current transformers (CTs)

Measurement and instrumentation

**PRODUCT ADVANTAGES**

- + EXTENDED RANGE:**  
primary currents from 5 to 5,000 A and 5 A or 1 A secondary currents
- + DIN RAIL MOUNTING:**  
on plate mounting or fixed around busbars
- + COMPACT DESIGN**

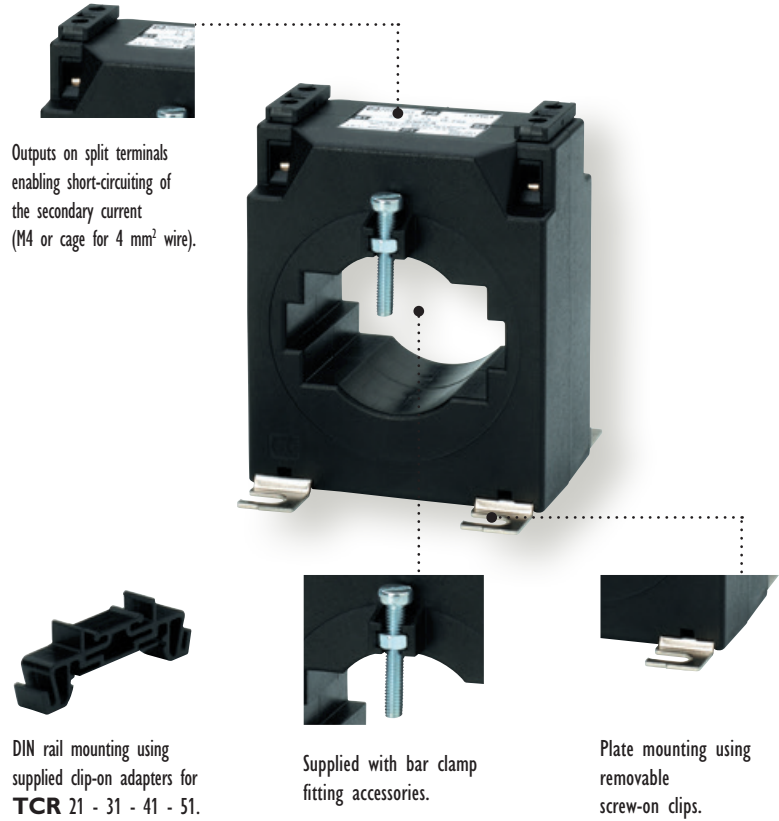

## ► General specifications

**Reference standards:**  
EN 60044-1 (ex IEC 185)  
**Maximum network voltage:**  
720 Vac  
**Dielectric test voltage:**  
3 kV/50 Hz/1 min  
**Frequency response:** 50/60 Hz  
**Short-circuit thermal current (I<sub>th</sub>):** 60 I<sub>n</sub> - 1 second  
**Dynamic current (I<sub>dyn</sub>):** 2.5 I<sub>th</sub>  
**Safety factor:** < 5

**Operating conditions**  
Temperature: -10°C to +50°C  
Relative humidity: < 90%  
**Protection**  
Protection rating: IP 50 (terminal covers supplied)  
Dry winding with self-extinguishing ABS covering (UL 94VO)

## ► 3CT Mounting

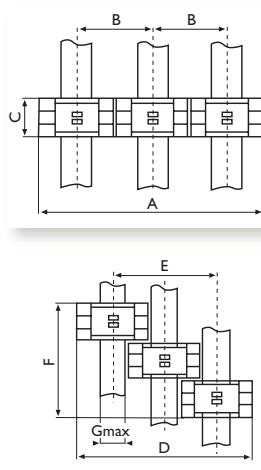

Model	Dimensions						
	A	B	C	D	E	F	G
TCR 10	-	-	-	-	-	-	-
TCR 11	-	-	-	-	-	-	-
TCR 15	-	-	-	-	-	-	-
TCR 21	176	59	32	143.6	85.6	98	25.6
TCR 31	176	59	32	148.6	90.6	98	30.6
TCR 41	194	65	44	160.6	96.6	134	30.6
TCR 51	194	65	44	170.6	106.6	134	40.6
TCR 61	255.5	85.5	50	231.6	147.1	152	60.6
TCR 71	326	109	50	298.6	190.6	152	80.6
TCR 80	287	96	59	215	120	179	23
TCR 90	347	116	44	264	149	134	32
TCR 100	374	125	44	310	186	134	60

## ► Mounting accessories

Model	DIN rail fittings	Plate mounting fittings	Sealable terminal cover*
TCR 10	1923 0021	•	•
TCR 11	1923 0021	•	•
TCR 15	•	•	•
TCR 21	•	•	1923 0022
TCR 31	•	•	1923 0022
TCR 41	•	•	1923 0022
TCR 51	•	•	1923 0022
TCR 61	•	•	1923 0022
TCR 71	•	•	1923 0022
TCR 75	•	•	1923 0022
TCR 80	•	•	•
TCR 90	•	•	•
TCR 100	•	•	•

• Standard accessories

\* sold in pairs

## TCR Wound primary

## TCR 10

25 x 25 mm aperture

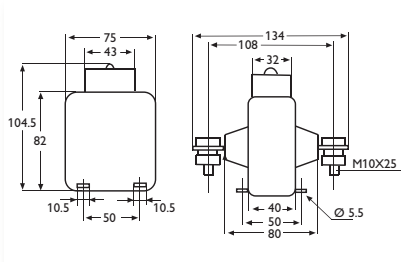

Primary	Power (VA) class			Weight (kg)
	0.5	1	3	
5 A	15	20	30	0.70
10 A	15	20	30	0.70
15 A	15	20	30	0.70
20 A	15	20	30	0.70
25 A	15	20	30	0.70
30 A	15	20	30	0.70
40 A	15	20	30	0.70
50 A	15	20	30	0.80
60 A	15	20	30	0.80
75 A	15	20	30	0.75
100 A	15	20	30	0.70
125 A	15	20	30	0.70
150 A	15	20	30	0.70

## TCR 11

Ø M4 and M6

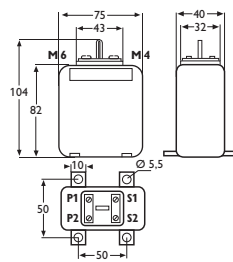

Primary	Power (VA) class		Weight (kg)
	1	3	
5 A	5	5	0.50
10 A	5	5	0.50
15 A	5	5	0.50
20 A	5	5	0.50
25 A	5	5	0.50
30 A	5	5	0.50
40 A	5	5	0.50
50 A	5	5	0.50
60 A	5	5	0.50

## TCR 15

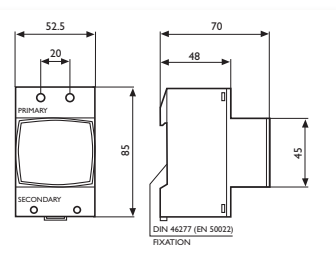
Primary: 16 mm<sup>2</sup> wire  
Secondary: 4 mm<sup>2</sup> wire

Primary	Power (VA) class			Weight (kg)
	0.5	1	3	
5 A	2.5	5	7	0.28
10 A	2.5	5	7	0.28
15 A	2.5	5	7	0.28
20 A	2.5	5	7	0.28
25 A	2.5	5	7	0.28
30 A	2.5	5	7	0.28
40 A	2.5	5	7	0.28
50 A	2.5	5	7	0.28

## TO ORDER

Primary	Secondary 1 A	Secondary 5 A
5 A	1921 1507	1920 1507
10 A	1921 1512	1920 1512
15 A	1921 1514	1920 1514
20 A	1921 1515	1920 1515
25 A	1921 1516	1920 1516
30 A	1921 1517	1920 1517
40 A	1921 1518	1920 1518
50 A	1921 1519	1920 1519
60 A	1921 1521	1920 1521
75 A	1921 1523	1920 1523
100 A		1920 1525
125 A		1920 1526
150 A		1920 1528

Primary	Secondary 1 A	Secondary 5 A
5 A	1921 1607	1920 1607
10 A	1921 1612	1920 1612
15 A	1921 1614	1920 1614
20 A	1921 1615	1920 1615
25 A	1921 1616	1920 1616
30 A	1921 1617	1920 1617
40 A	1921 1618	1920 1618
50 A	1921 1619	1920 1619
60 A	1921 1621	1920 1621

Primary	Secondary 1 A	Secondary 5 A
5 A	1921 1707	1920 1707
10 A	1921 1712	1920 1712
15 A	1921 1714	1920 1714
20 A	1921 1715	1920 1715
25 A	1921 1716	1920 1716
30 A	1921 1717	1920 1717
40 A	1921 1718	1920 1718
50 A	1921 1719	1920 1719

## ► Associated products

PRTC  
CT protection unit

► page 143

Mounting  
accessories

► page 112





# TCR Range

Cable/busbar primary

Current transformers (CTs)

► Measurement and instrumentation

## TCR 21

Cable Ø 20 mm  
Bar: 15 x 10 mm - 20 x 10 mm  
25 x 5 mm

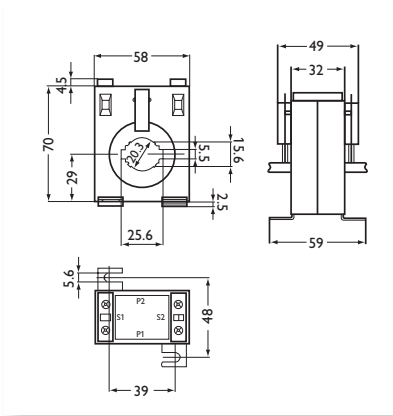

Primary	Power (VA) class			Weight (kg)
	0.5	1	3	
40 A	-	-	1.5	0.41
50 A	-	-	3	0.42
60 A	-	1.25	3.5	0.43
75 A	-	2	3.5	0.44
100 A	1.5	2.5	3.75	0.44
125 A	1.75	3.5	5	0.45
150 A	2.5	3.5	5	0.29
200 A	3.75	5	5	0.30
250 A	5	7.5	7.5	0.31

## TCR 31

Cable Ø 22 mm  
Bar: 20 x 12 mm - 25 x 11 mm  
30 x 10 mm

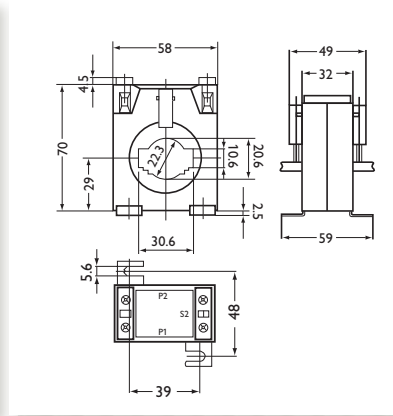

Primary	Power (VA) class			Weight (kg)
	0.5	1	3	
100 A	-	1	1.5	0.53
125 A	-	1	2	0.53
150 A	1	2	2.5	0.53
200 A	2.5	3	3.5	0.54
250 A	3.5	3.75	5	0.54
300 A	3.5	3.75	5	0.51
400 A	3.5	5	7.5	0.51
500 A	5	7.5	10	0.51
600 A	5	7.5	10	0.52

## TCR 41

Cable Ø 26 mm  
Bar: 20 x 20 mm - 25 x 12 mm  
30 x 10 mm

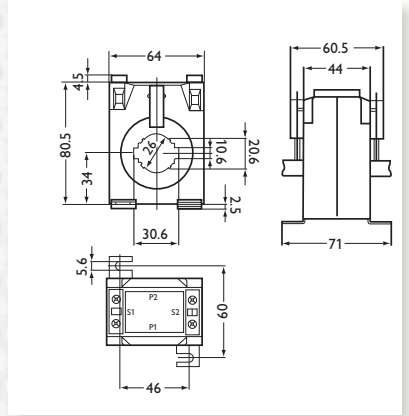

Primary	Power (VA) class			Weight (kg)
	0.5	1	3	
100 A	1.75	3.75	7.5	0.53
125 A	3.75	7.5	10	0.53
150 A	5	7.5	10	0.53
200 A	7.5	10	10	0.54
250 A	7.5	10	15	0.54
300 A	10	10	15	0.51
400 A	10	10	15	0.51
500 A	15	15	20	0.51
600 A	15	20	25	0.51

### TO ORDER

Primary	Secondary 1 A	Secondary 5 A
40 A	1921 2318B	1920 2318B
50 A	1921 2319B	1920 2319B
60 A	1921 2321B	1920 2321B
75 A	1921 2323B	1920 2323B
100 A	1921 2325B	1920 2325B
125 A	1921 2326B	1920 2326B
150 A	1921 2328B	1920 2328B
200 A	1921 2330B	1920 2330B
250 A	1921 2331B	1920 2331B

Primary	Secondary 1 A	Secondary 5 A
100 A	1921 2425B	1920 2425B
125 A	1921 2426B	1920 2426B
150 A	1921 2428B	1920 2428B
200 A	1921 2430B	1920 2430B
250 A	1921 2431B	1920 2431B
300 A	1921 2433B	1920 2433B
400 A	1921 2435B	1920 2435B
500 A	1921 2436B	1920 2436B
600 A	1921 2438B	1920 2438B

Primary	Secondary 1 A	Secondary 5 A
100 A	1921 2525B	1920 2525B
125 A	1921 2526B	1920 2526B
150 A	1921 2528B	1920 2528B
200 A	1921 2530B	1920 2530B
250 A	1921 2531B	1920 2531B
300 A	1921 2533B	1920 2533B
400 A	1921 2535B	1920 2535B
500 A	1921 2536B	1920 2536B
600 A	1921 2538B	1920 2538B

### ► Associated products

PRTC  
CT protection unit

► page 142



Mounting  
accessories

► page 112



## TCR 51

Cable Ø 28 mm  
Bar: 20 x 25 mm - 30 x 15 mm  
40 x 10 mm

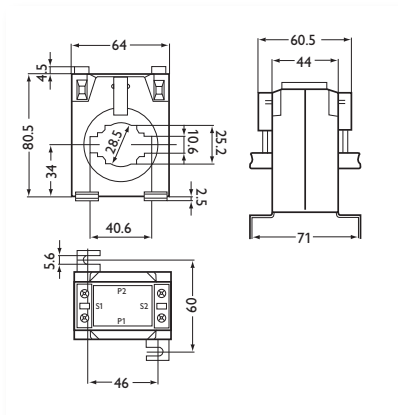

Primary	Power (VA) class			Weight (kg)
	0.5	1	3	
100 A	0.5	1	2.5	0.36
125 A	0.75	1.5	3.75	0.37
150 A	1	3.5	5	0.37
200 A	3.5	5	7.5	0.38
250 A	5	7.5	10	0.39
300 A	5	7.5	10	0.40
400 A	5	7.5	10	0.41
500 A	7.5	10	15	0.41
600 A	7.5	10	15	0.42
750 A	10	15	20	0.43
800 A	10	15	20	0.44

## TCR 61

Cable Ø 44 mm  
Bar: 50 x 30 mm - 60 x 12 mm

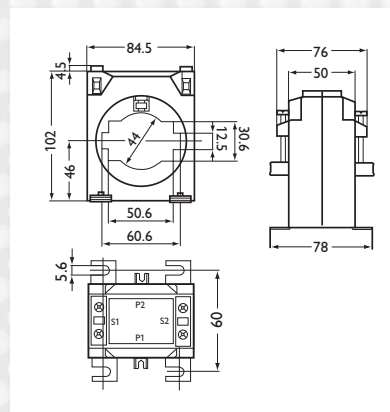

Primary	Power (VA) class			Weight (kg)
	0.5	1	3	
400 A	5	7.5	10	0.5
500 A	7.5	10	15	0.52
600 A	10	15	20	0.52
750 A	15	20	25	0.59
800 A	15	20	30	0.60
1000 A	15	20	30	0.61
1200 A	15	20	30	0.63
1500 A	15	20	30	0.65

### TO ORDER

Primary	Secondary 1 A	Secondary 5 A
100 A	1921 3425B	1920 3425B
125 A	1921 3426B	1920 3426B
150 A	1921 3428B	1920 3428B
200 A	1921 3430B	1920 3430B
250 A	1921 3431B	1920 3431B
300 A	1921 3433B	1920 3433B
400 A	1921 3435B	1920 3435B
500 A	1921 3436B	1920 3436B
600 A	1921 3438B	1920 3438B
750 A	1921 3440B	1920 3440B
800 A	1921 3441B	1920 3441B

Primary	Secondary 1 A	Secondary 5 A
400 A	1921 4735B	1920 4735B
500 A	1921 4736B	1920 4736B
600 A	1921 4738B	1920 4738B
750 A	1921 4740B	1920 4740B
800 A	1921 4741B	1920 4741B
1000 A	1921 4742B	1920 4742B
1200 A	1921 4751B	1920 4751B
1500 A	1921 4744B	1920 4744B

### ► Associated products

PRTC  
CT protection unit

► page 142



Mounting  
accessories

► page 112





# TCR Range

Cable/busbar primary

Current transformers (CTs)

▶ Measurement and instrumentation

## TCR 71

Cable Ø 63 mm  
Bar: 50 x 50 mm - 60 x 37 mm  
80 x 30 mm

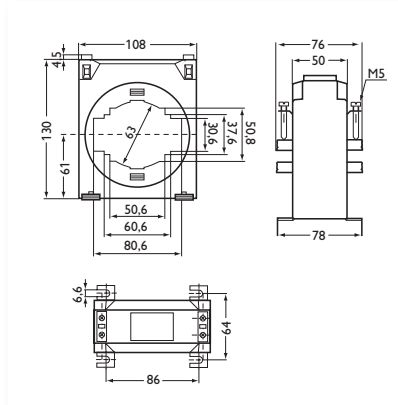

Primary	Power (VA) class			Weight (kg)
	0.5	1	3	
400 A	5	7.5	10	0.82
500 A	5	7.5	10	0.80
600 A	7.5	10	15	0.83
750 A	7.5	10	15	0.88
800 A	7.5	10	15	0.66
1000 A	10	15	20	0.72
1200 A	10	15	20	0.68
1500 A	15	20	25	0.84
2000 A	15	20	25	0.82
2500 A	15	20	30	0.88
3000 A	15	20	30	0.88

## TCR 75

Bar: 3 x 100 mm x 10 mm

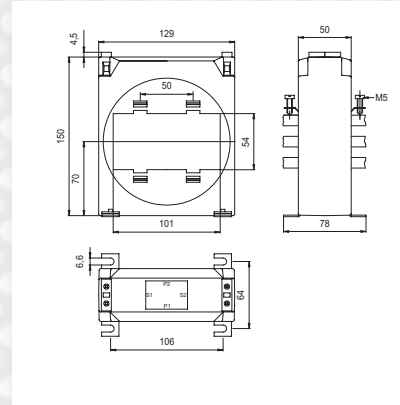

Primary	Power (VA) class			Weight (kg)
	0.5	1	3	
1500 A	15	20	30	1.47
2000 A	15	20	30	1.55
2500 A	20	30	40	1.63
3000 A	30	40	60	1.71
4000 A	35	40	60	1.87

### TO ORDER

Primary	Secondary 1 A	Secondary 5 A
400 A	1921 4635B	1920 4635B
500 A	1921 4636B	1920 4636B
600 A	1921 4638B	1920 4638B
750 A	1921 4640B	1920 4640B
800 A	1921 4641B	1920 4641B
1000 A	1921 4642B	1920 4642B
1200 A	1921 4651B	1920 4651B
1500 A	1921 4644B	1920 4644B
2000 A	1921 4645B	1920 4645B
2500 A	1921 4646B	1920 4646B
3000 A	1921 4647B	1920 4647B

Primary	Secondary 1 A	Secondary 5 A
1500 A	1921 5044B	1920 5044B
2000 A	1922 5045B	1920 5045B
2500 A	1923 5046B	1920 5046B
3000 A	1924 5047B	1920 5047B
4000 A	1925 5049B	1920 5049B

### ▶ Associated products

PRTC  
CT protection unit

▶ page 142



Mounting  
accessories

▶ page 112





# TCR Range

Busbar primary

## TCR 80

Bar: 100 x 20 mm

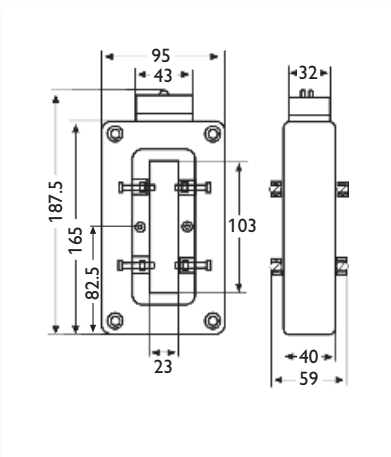

Primary	Power (VA) class			Weight (kg)
	0.5	1	3	
750 A	15	20	30	0.80
800 A	15	20	30	0.80
1000 A	15	20	30	0.76
1200 A	15	20	30	0.76
1500 A	15	30	40	0.76
2000 A	20	40	50	0.76

## TCR 90

Bar: 100 x 30 mm

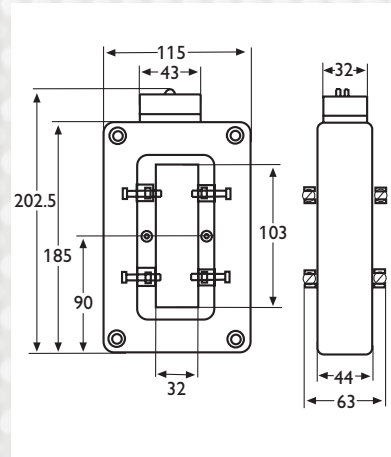

Primary	Power (VA) class			Weight (kg)
	0.5	1	3	
1500 A	15	30	40	0.76
2000 A	20	40	50	0.82
2500 A	20	40	50	0.78
3000 A	20	45	60	0.90
4000 A	35	50	70	0.90

## TCR 100

Bar: 125 x 60 mm

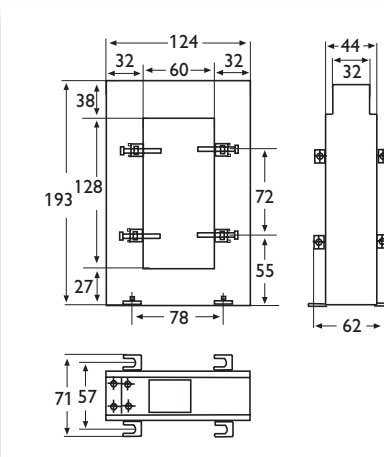

Primary	Power (VA) class			Weight (kg)
	0.5	1	3	
1000 A	15	20	30	0.75
1200 A	15	20	30	0.80
1500 A	15	20	30	0.83
2000 A	15	20	30	0.92
2500 A	20	30	40	1.01
3000 A	30	40	60	1.09
4000 A	35	50	70	1.21
5000 A	40	60	80	1.44

### TO ORDER

Primary	Secondary 1 A	Secondary 5 A
750 A	1921 5640	1920 5640
800 A	1921 5641	1920 5641
1000 A	1921 5642	1920 5642
1200 A	1921 5651	1920 5651
1500 A	1921 5644	1920 5644
2000 A	1921 5645	1920 5645

Primary	Secondary 1 A	Secondary 5 A
1500 A	1921 6644	1920 6644
2000 A	1921 6645	1920 6645
2500 A	1921 6646	1920 6646
3000 A	1921 6647	1920 6647
4000 A	1921 6649	1920 6649

Primary	Secondary 1 A	Secondary 5 A
1000 A	1921 6842	1920 6842
1200 A	1921 6851	1920 6851
1500 A	1921 6844	1920 6844
2000 A	1921 6845	1920 6845
2500 A	1921 6846	1920 6846
3000 A	1921 6847	1920 6847
4000 A	1921 6849	1920 6849
5000 A		1920 6850

### ► Associated products

PRTC  
CT protection unit

► page 142







# TCRO Range

CTs designed for insertion on electrical installations without opening the conductor.

Current transformers (CTs)

Measurement and instrumentation

## PRODUCT ADVANTAGES

- +** **PRIMARY**  
from 200 to 5,000 A  
and wide choice of  
primary options
- +** **FULLY OPENING**  
primary

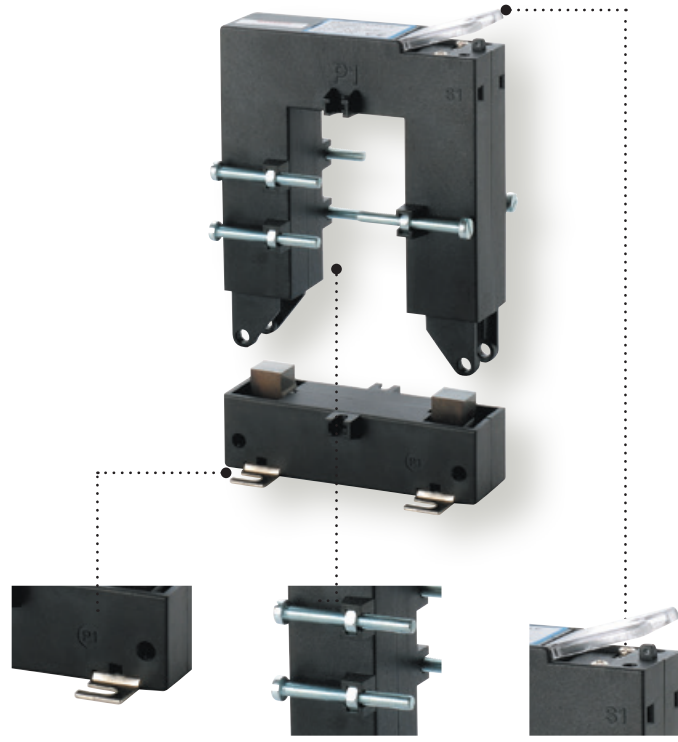

Plate mounting fitting

Bar clamp fitting

Captive sealable terminal covers. Split output terminals enabling risk-free short-circuiting of the secondary current (cage for 4 mm<sup>2</sup> wire)

## ► General specifications

**Reference standard:**  
EN 60044-1 (ex IEC 185)  
**Maximum network voltage:**  
720 Vac  
**Dielectric test voltage:**  
3 kV/50 Hz/1 min  
**Frequency response:** 50/60 Hz  
**Short-circuit thermal current (I<sub>th</sub>):** 60 I<sub>n</sub> - 1 second  
**Dynamic current (I<sub>dyn</sub>):** 2.5 I<sub>th</sub>  
**Safety factor:** < 5

**Operating conditions:**  
Temperature: -10°C to +50°C  
Relative humidity: < 90%  
**Protection:**  
Protection rating: IP 50 (terminal covers supplied)  
Dry winding with self-extinguishing ABS covering (UL 94 VO)

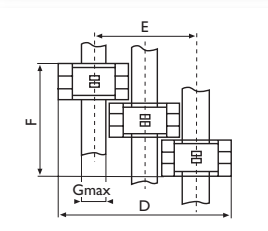
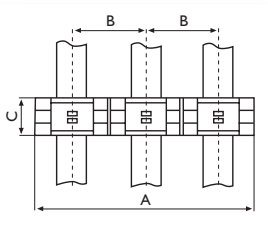

## ► 3CT Mounting

Model	Dimensions						
	A	B	C	D	E	F	G
TCRO 2030	269	90	40	200	111	122	20
TCRO 5080	344	115	32	280	166	98	50
TCRO 8080	434	145	32	370	226	98	80
TCRO 80120	434	145	32	370	226	98	80
TCRO 80160	554	185	52	450	266	158	80

## ► Mounting accessories

Model	Plate mounting fittings	Busbar clamp
	TCRO 2030	•
TCRO 5080	•	•
TCRO 8080	•	•
TCRO 80120	•	•
TCRO 80160	•	•

• Standard accessories

## TCRO 2030

Bar: 20 x 30 mm

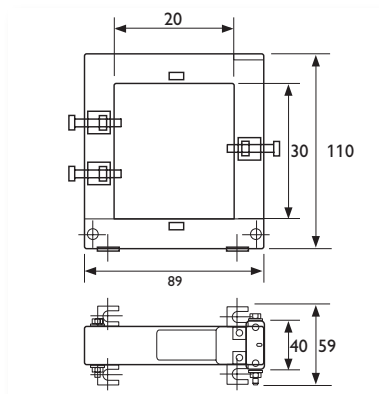

Primary	Power (VA) class			Weight (kg)
	0.5	1	3	
100 A	-	-	1.5	0.75
150 A	-	-	2	0.75
200 A	-	1.5	2.5	0.75
250 A	-	2	4	0.75
300 A	1.5	4	6	0.75
400 A	2.5	6	10	0.75

## TCRO 5080

Bar: 50 x 80 mm

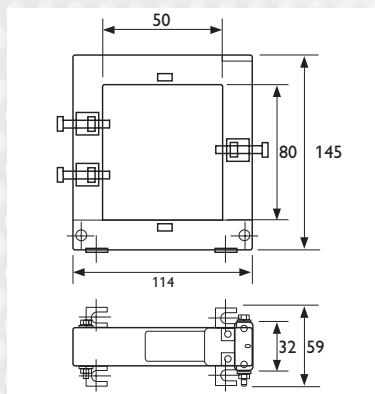

Primary	Power (VA) class			Weight (kg)
	0.5	1	3	
250 A	1	2	4	0.90
300 A	1.5	3	6	0.90
400 A	1.5	3	10	0.90
500 A	2.5	5	15	0.90
600 A	2.5	5	17.5	0.90
800 A	3	7	18	0.90
1000 A	5	10	20	0.90

## TCRO 8080

Bar: 80 x 80 mm

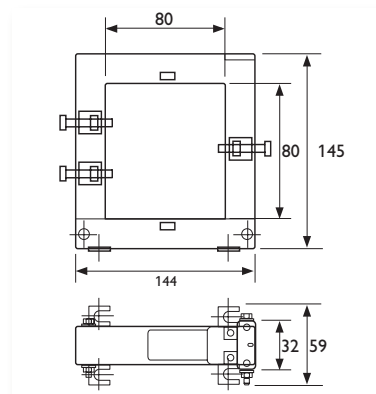

Primary	Power (VA) class			Weight (kg)
	0.5	1	3	
250 A	1	2	4	1.00
300 A	1.5	3	6	1.00
400 A	1.5	3	10	1.00
500 A	2.5	5	15	1.00
600 A	2.5	5	17.5	1.00
800 A	3	7	18	1.00
1000 A	5	10	20	1.00

### TO ORDER

Primary	Secondary 5 A
100 A	1920 8328
150 A	1920 8329
200 A	1920 8330
250 A	1920 8331
300 A	1920 8333
400 A	1920 8335

1 A on request

Primary	Secondary 5 A
250 A	1920 8431
300 A	1920 8433
400 A	1920 8435
500 A	1920 8436
600 A	1920 8438
800 A	1920 8441
1000 A	1920 8442

1 A secondary on request

Primary	Secondary 5 A
250 A	1920 8531
300 A	1920 8533
400 A	1920 8535
500 A	1920 8536
600 A	1920 8538
800 A	1920 8541
1000 A	1920 8542

1 A secondary on request

## ► Associated products

PRTC  
CT protection unit

► page 142





# TCRO Range

Split core

Current transformers (CTs)

Measurement and instrumentation

## TCRO 80120

Bar: 80 x 120 mm

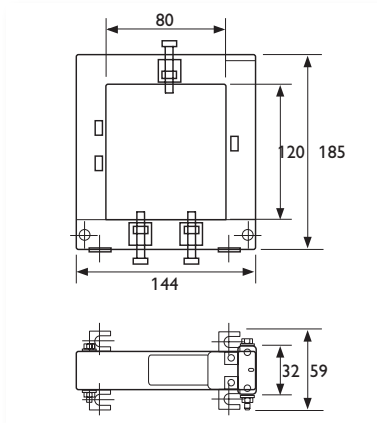

Primary	Power (VA) class			Weight (kg)
	0.5	1	3	
500 A	-	4	12	1.20
600 A	-	5	14	1.20
800 A	3	7	18	1.20
1000 A	5	9	20	1.20
1200 A	6	11	28	1.20
1500 A	8	17	30	1.20

## TCRO 80160

Bar: 80 x 160 mm

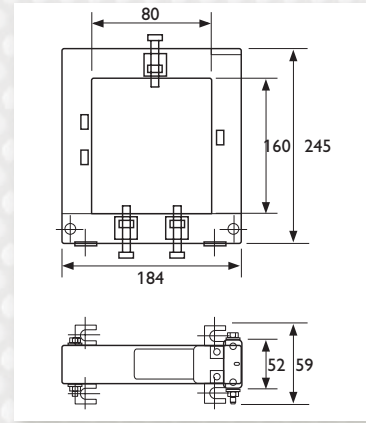

Primary	Power (VA) class			Weight (kg)
	0.5	1	3	
1000 A	10	15	20	3.50
1500 A	15	20	25	3.50
2000 A	15	20	25	3.50
2500 A	15	20	25	3.50
3000 A	20	25	30	3.50
4000 A	20	25	30	3.50
5000 A	20	25	30	3.50

TO ORDER

Primary	Secondary 5 A
500 A	1920 8636
600 A	1920 8638
800 A	1920 8641
1000 A	1920 8642
1200 A	1920 8643
1500 A	1920 8644

1 A on request

Primary	Secondary 5 A
1000 A	1920 8742
1500 A	1920 8744
2000 A	1920 8745
2500 A	1920 8746
3000 A	1920 8747
4000 A	1920 8749
5000 A	1920 8750

1 A on request

### ► Associated products

PRTC  
CT protection unit

► page 142



# TC CLIP Range

Very compact current transformer for inclusion on electrical installations without disconnecting the power cables

## PRODUCT ADVANTAGES

- + **QUICK AND EASY IMPLEMENTATION**  
without cutting off the power
- + **Built-in SHORT-CIRCUITING SWITCH**
- + **REINFORCED HINGE**
- + **VERY COMPACT**
- + **PRIMARY**  
from 60 to 600 A



## ► General specifications

**Maximum network voltage:** 720 Vac  
**Dielectric test voltage:** 3 kV 50 Hz 1 min  
**Secondary current:** 1 A  
**Power:** 0.5 VA  
**Frequency:** 50/60 Hz  
**Operating temperature:** -20°C to +50°C  
**Storage temperature:** -30°C to 90°C  
**Accuracy class:** 1 %

The **TC CLIP** models are compatible with all the measuring products with input on CT available on the market, and particularly ENERIUM power monitors and ULYS submeters from ENERDIS®.



# Current transformers (CTs)

## Measurement and instrumentation

### TCC176

Cable Ø 17 mm

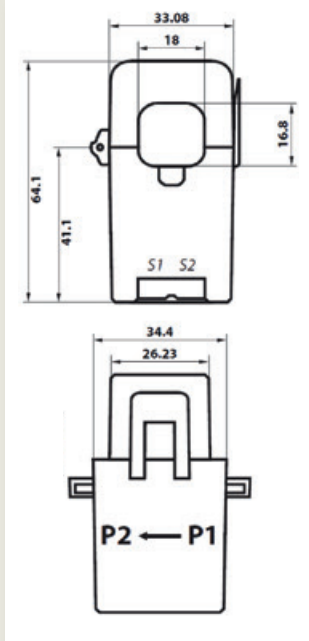

### TCC241 / TCC242

Cable Ø 24 mm

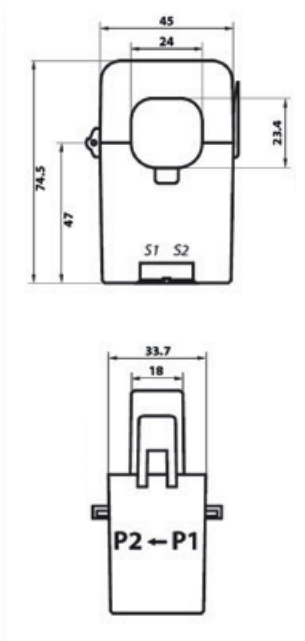

### TCC364 / TCC366

Cable Ø 36 mm

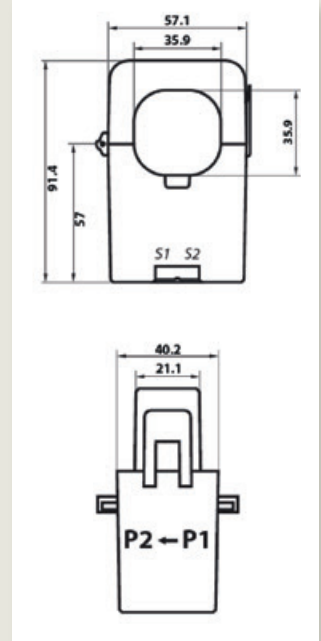

	TCC 176	TCC 241	TCC 242	TCC 364	TCC 366
Primary	60 A	100 A	250 A	400 A	600 A
Secondary	1A				
Power	0,2 VA				0,5 VA
Accuracy class	3 %				1 %
Diameter	17 mm	24 mm	24 mm	36 mm	36 mm
Dimensions (mm)	64 x 33 x 34,4	74,5 x 45 x 34	74,5 x 45 x 34	91 x 57 x 40,5	91 x 57 x 40,5
Weight (g)	128	162	187	263	300

### TO ORDER

Model	Primary / Secondary	Reference	Pack of 3 TC CLIP	Reference
TCC 176	60 A / 1 A	P01379609	Pack of 3 TCC 176	P01379610
TCC 241	100 A / 1 A	P01379601	Pack of 3 TCC 241	P01379605
TCC 242	250 A / 1 A	P01379602	Pack of 3 TCC 242	P01379606
TCC 364	400 A / 1 A	P01379603	Pack of 3 TCC 364	P01379607
TCC 366	600 A / 1 A	P01379604	Pack of 3 TCC 366	P01379608

## Associated products

RENOV ENERGY  
Metering solutions

► page 52



# JVR-JVO-JVP Ranges

CTs designed to supply analogue or digital measurement instruments.  
Accuracy class 0.5/1/3

## PRODUCT ADVANTAGES

- + COMPLETE RANGE:**  
primary from 1 to 3,000 A  
and 5 A or 1 A secondary
- + TOTALLY ADAPTABLE RANGE**  
for specific requirements  
(primary, secondary,  
power class, frequency)



Sealable cover  
M5 terminals with  
2 grooves for dual  
connection on secondary



Central pipe accessory on cable  
primary JVO for compact lateral  
primary connection

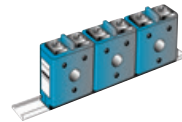

Mounting on symmetrical  
rail (except for JVP) or plate  
mounting in cabinet

## ► General specifications

**Reference standard:** EN 60044-1  
(ex IEC 185)

**Maximum network voltage:**  
720 Vac

**Dielectric test voltage:**  
3 kV/50 Hz/1 min

**Frequency response:** 50/60 Hz

**Short-circuit thermal current (I<sub>th</sub>):**

JVO, JVP: 80 I<sub>n</sub>

JVR 86: 60 I<sub>n</sub>

JVR 64, JVR 75: 40 I<sub>n</sub>

**Dynamic current (I<sub>dyn</sub>):** 2.5 I<sub>th</sub>

**Safety factor:** 5 in Class 1

**Operating conditions:**

Temperature: -5°C to +50°C

Relative humidity: 93% at 40°C

**Protection:**

Protection rating: IP 50

(with terminal cover supplied)

Dry winding with self-extinguishing ABS  
covering (UL 94 VO)

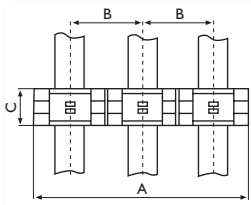

## ► 3 CT mounting

Dimensions

Model	A	B	C	D	E	F	G
JVO 25 CR	227	76	45	184.5	109.5	137	32.5
JVO 32 CR	260	87	58	214.5	128.5	176	40.5
JVP 624	296	99	35	220	122	107	22
JVP 1025	344	115	45	252	138	137	22
JVP 1045	404	135	45	312	178	137	42

## ► Mounting accessories

For model	1CT mounting rail	2CT mounting rail	3CT mounting rail
JVR	ACCE 7652	ACCE 7653	ACCE 7655
JVO 12-18	ACCE 7650	ACCE 7651	ACCE 7654
JVO 21-25-32-36	ACCE 7652	ACCE 7653	ACCE 7655
J3R 80 B	ACCE 7640		

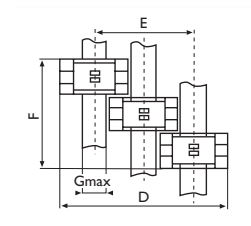





# JVR-JVO-JVP Ranges

JVR – Wound primary

Current transformers (CTs)

Measurement and instrumentation

## JVR 64

Ø M8

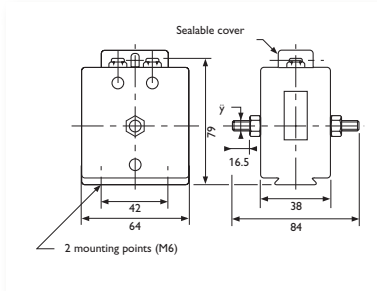

Primary	Power (VA) class			Weight (kg)
	0.5	1	3	
5 A	*	5	5	0.45
10 A	*	5	5	0.45
15 A	*	5	5	0.45
20 A	*	5	5	0.45
25 A	*	5	5	0.45
30 A	*	5	5	0.45
40 A	*	5	5	0.45
50 A	*	5	5	0.45
60 A	*	5	5	0.45
75 A	*	5	5	0.45
100 A	*	5	5	0.45

\*On request

## JVR 75

Ø M8/M10 > 75 A

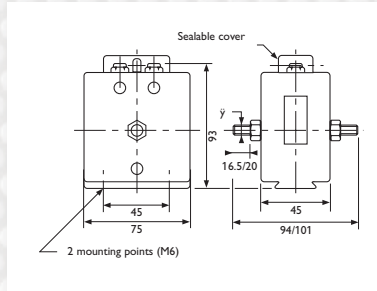

Primary	Power (VA) class			Weight (kg)
	0.5	1	3	
5 A	*	10	10	0.6
10 A	*	10	10	0.6
15 A	*	10	10	0.6
20 A	*	10	10	0.6
25 A	*	10	10	0.6
30 A	*	10	10	0.6
40 A	*	10	10	0.6
50 A	*	10	10	0.6
60 A	*	10	10	0.6
75 A	*	10	10	0.6
100 A	*	10	10	0.6
125 A	*	10	10	0.6
150 A	*	10	10	0.6
200 A	*	10	10	0.6

\*On request

## JVR 86

Ø M8/M10 > 75 A

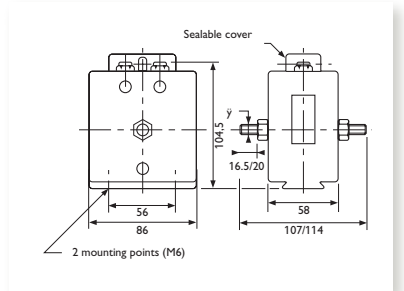

Primary	Power (VA) class			Weight (kg)
	0.5	1	3	
5 A	*	20	30	1.2
10 A	*	20	30	1.2
15 A	*	20	30	1.2
20 A	*	20	30	1.2
25 A	*	20	30	1.2
30 A	*	20	30	1.2
40 A	*	20	30	1.2
50 A	*	20	30	1.2
60 A	*	20	30	1.2
75 A	*	20	30	1.2
100 A	*	20	30	1.2
125 A	*	20	30	1.2
150 A	*	20	30	1.2
200 A	*	20	30	1.2

\*On request

### TO ORDER

Primary	Secondary 5 A
5 A	JVRA 8700
10 A	JVRA 8701
15 A	JVRA 8702
20 A	JVRA 8703
25 A	JVRA 8704
30 A	JVRA 8705
40 A	JVRA 8706
50 A	JVRA 8707
60 A	JVRA 8708
75 A	JVRA 8709
100 A	JVRA 8710
Sealable cover	ACCE 7668

Primary	Secondary 5 A
5 A	JVRB 8725
10 A	JVRB 8726
15 A	JVRB 8727
20 A	JVRB 8728
25 A	JVRB 8729
30 A	JVRB 8730
40 A	JVRB 8731
50 A	JVRB 8732
60 A	JVRB 8733
75 A	JVRB 8734
100 A	JVRB 8735
125 A	JVRB 8736
150 A	JVRB 8737
200 A	JVRB 8738
Sealable cover	ACCE 7668

Primary	Secondary 5 A
5 A	JVRC 8742
10 A	JVRC 8743
15 A	JVRC 8744
20 A	JVRC 8745
25 A	JVRC 8746
30 A	JVRC 8747
40 A	JVRC 8748
50 A	JVRC 8749
60 A	JVRC 8750
75 A	JVRC 8751
100 A	JVRC 8752
125 A	JVRC 8753
150 A	JVRC 8754
200 A	JVRC 8755
Sealable cover	ACCE 7668

### Customized product

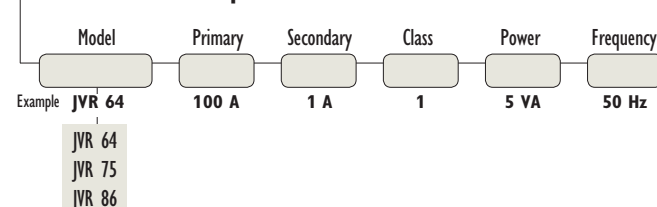

### Associated products

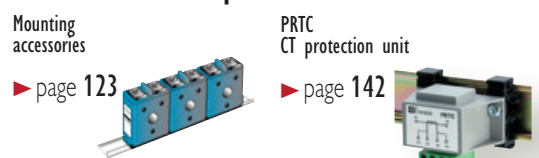

# JVR-JVO-JVP Ranges

## JVO – Cable primary

### JVO 12-46

Cable Ø 12 mm

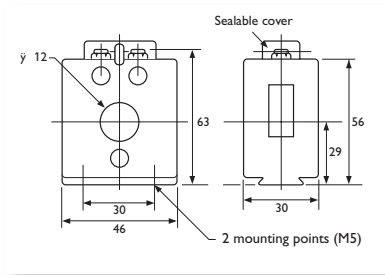

Primary	Power (VA) class			Weight (kg)
	0.5	1	3	
40 A	-	-	1.5	0.20
50 A	-	-	2	0.20
60 A	-	-	2.5	0.20
75 A	-	-	3	0.20
100 A	-	-	4	0.20
125 A	-	-	5	0.20
150 A	-	-	5	0.20

### JVO 18-51

Cable Ø 18 mm

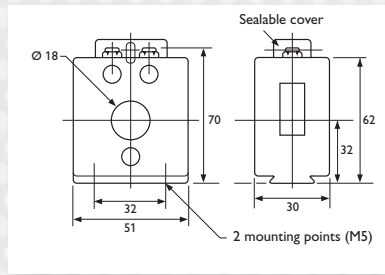

Primary	Power (VA) class			Weight (kg)
	0.5	1	3	
100 A	-	-	2	0.25
125 A	-	2.5	3	0.25
150 A	-	3	4	0.25
200 A	-	4	6	0.25
250 A	-	5	7	0.25
300 A	-	5	8	0.25

### JVO 21-64

Cable Ø 21 mm

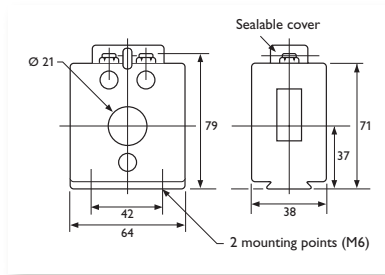

Primary	Power (VA) class			Weight (kg)
	0.5	1	3	
100 A	-	-	4	0.35
125 A	-	-	5	0.35
150 A	-	-	5	0.35
200 A	-	5	5	0.35
250 A	-	5	5	0.35
300 A	*	5	10	0.35
400 A	*	5	10	0.35
500 A	*	10	20	0.35
600 A	*	10	20	0.35

\*On request

### TO ORDER

Primary	Secondary 5 A
40 A	JVOA 8759
50 A	JVOA 8760
60 A	JVOA 8761
75 A	JVOA 8762
100 A	JVOA 8763
125 A	JVOA 8764
150 A	JVOA 8765
Central tube	ACCE 7660

Primary	Secondary 5 A
100 A	JVOB 8769
125 A	JVOB 8770
150 A	JVOB 8771
200 A	JVOB 8772
250 A	JVOB 8773
300 A	JVOB 8774
Central tube	ACCE 7661

Primary	Secondary 5 A
100 A	JVOC 8778
125 A	JVOC 8779
150 A	JVOC 8780
200 A	JVOC 8781
250 A	JVOC 8782
300 A	JVOC 8783
400 A	JVOC 8784
500 A	JVOC 8785
600 A	JVOC 8786
Central tube	ACCE 7662
Sealable cover	ACCE 7668

### Customized product

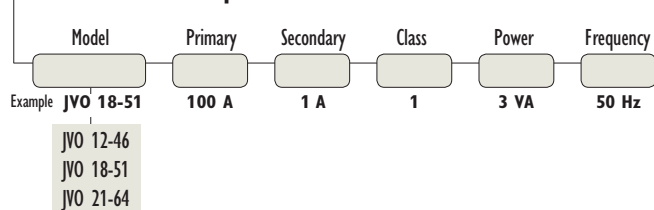

### Associated products

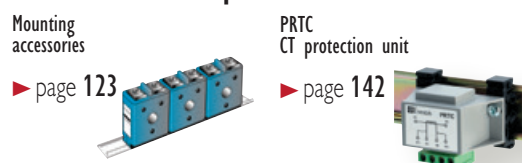



# JVR-JVO-JVP Ranges

JVO – Cable primary

Current transformers (CTs)

Measurement and instrumentation

## JVO 21-75

Cable Ø 21 mm

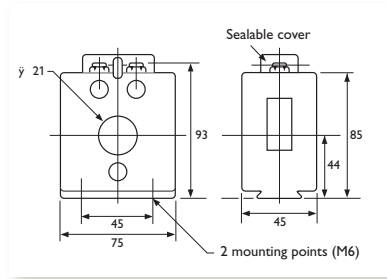

Primary	Power (VA) class			Weight (kg)
	0.5	1	3	
50 A	-	-	5	0.65
60 A	-	-	5	0.65
75 A	-	-	10	0.65
100 A	-	4	10	0.65
125 A	-	5	10	0.65
150 A	*	10	15	0.65
200 A	*	10	15	0.65
250 A	*	15	20	0.65
300 A	*	15	20	0.65
400 A	*	20	30	0.65
500 A	*	30	30	0.65
600 A	*	30	30	0.65

\*On request

## JVO 32-75

Cable Ø 32 mm

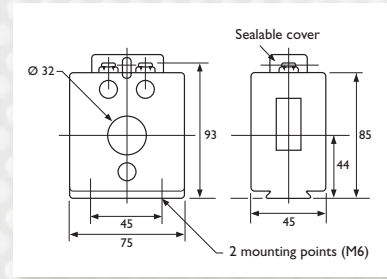

Primary	Power (VA) class			Weight (kg)
	0.5	1	3	
100 A	-	-	5	0.65
125 A	-	-	5	0.65
150 A	-	5	10	0.65
200 A	-	5	10	0.65
250 A	*	5	15	0.65
300 A	*	10	15	0.65
400 A	*	10	15	0.65
500 A	*	10	20	0.65
600 A	*	10	20	0.65

\*On request

## JVO 36-75

Cable Ø 36 mm

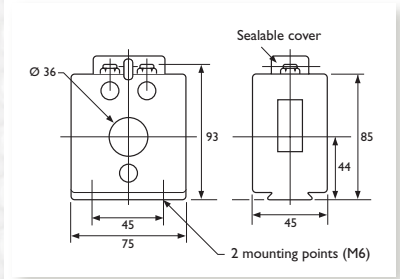

Primary	Power (VA) class			Weight (kg)
	0.5	1	3	
100 A	-	-	5	0.45
125 A	-	-	5	0.45
150 A	-	-	10	0.45
200 A	-	5	10	0.45
250 A	*	5	15	0.45
300 A	*	5	15	0.45
400 A	*	5	15	0.45
500 A	*	10	20	0.45
600 A	*	20	20	0.45

\*On request

### TO ORDER

Primary	Secondary 5 A
50 A	JVOE 8795
60 A	JVOE 8796
75 A	JVOE 8797
100 A	JVOE 8798
125 A	JVOE 8799
150 A	JVOE 8800
200 A	JVOE 8801
250 A	JVOE 8802
300 A	JVOE 8803
400 A	JVOE 8804
500 A	JVOE 8805
600 A	JVOE 8806
Central tube	ACCE 7663
Sealable cover	ACCE 7668

Primary	Secondary 5 A
100 A	JVOF 8814
125 A	JVOF 8815
150 A	JVOF 8816
200 A	JVOF 8817
250 A	JVOF 8818
300 A	JVOF 8819
400 A	JVOF 8820
500 A	JVOF 8821
600 A	JVOF 8822
Sealable cover	ACCE 7668

Primary	Secondary 5 A
100 A	JVOG 8829
125 A	JVOG 8830
150 A	JVOG 8831
200 A	JVOG 8832
250 A	JVOG 8833
300 A	JVOG 8834
400 A	JVOG 8835
500 A	JVOG 8836
600 A	JVOG 8837
Sealable cover	ACCE 7668

### Customized product

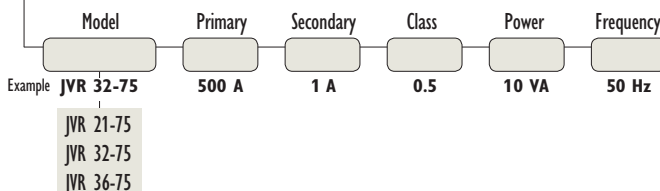

### Associated products

Mounting accessories

▶ page 123

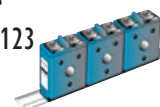

PRTC CT protection unit

▶ page 142



# JVR-JVO-JVP Ranges

## JVO – Cable primary

### J3R 80 B

Cable Ø 66 mm

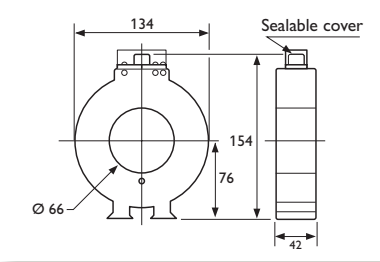

Primary	Power (VA) class			Weight (kg)
	0.5	1	3	
200 A	-	5	10	1.6
250 A	-	5	10	1.6
300 A	5	10	15	1.6
400 A	10	20	25	1.6
500 A	15	20	25	1.6
600 A	15	20	25	1.6
750 A	15	20	25	1.6
800 A	15	20	25	1.6
1000 A	15	20	25	1.6
1250 A	15	20	25	1.6
1500 A	15	20	25	1.6

### JVO 25 CR

Cable Ø 25 mm  
Bar: 32 x 10 mm

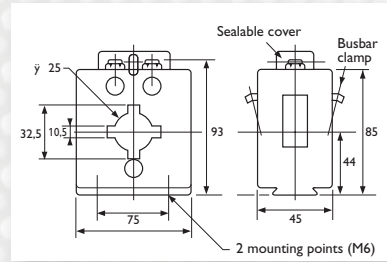

Primary	Power (VA) class			Weight (kg)
	0.5	1	3	
100 A	-	-	5	0.6
125 A	-	-	5	0.6
150 A	-	-	5	0.6
200 A	-	5	10	0.6
250 A	*	5	15	0.6
300 A	*	5	15	0.6
400 A	*	10	15	0.6
500 A	*	20	20	0.6
600 A	*	20	20	0.6

\*On request

### JVO 32 CR

Cable Ø 32 mm  
Bar: 40 x 10 mm

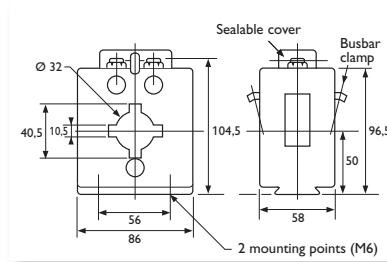

Primary	Power (VA) class			Weight (kg)
	0.5	1	3	
100 A	-	-	5	0.9
125 A	-	-	10	0.9
150 A	-	5	15	0.9
200 A	-	5	15	0.9
250 A	*	10	20	0.9
300 A	*	10	30	0.9
400 A	*	15	30	0.9
500 A	*	15	30	0.9
600 A	*	15	30	0.9

\*On request

## T O O R D E R

Primary	Secondary 5 A
200 A	J3RC 7514
250 A	J3RC 7524
300 A	J3RC 7525
400 A	J3RC 7528
500 A	J3RC 7527
600 A	J3RC 7529
750 A	J3RC 7526
800 A	J3RC 7531
1000 A	J3RC 7530
1250 A	J3RC 7532
1500 A	J3RC 7533
Sealable cover	ACCE 7671

Primary	Secondary 5 A
100 A	JVOD 8850
125 A	JVOD 8851
150 A	JVOD 8852
200 A	JVOD 8853
250 A	JVOD 8854
300 A	JVOD 8855
400 A	JVOD 8856
500 A	JVOD 8857
600 A	JVOD 8858
Busbar clamp	ACCE 7665
Sealable cover	ACCE 7668

Primary	Secondary 5 A
100 A	JVOH 8866
125 A	JVOH 8867
150 A	JVOH 8868
200 A	JVOH 8869
250 A	JVOH 8870
300 A	JVOH 8871
400 A	JVOH 8872
500 A	JVOH 8873
600 A	JVOH 8874
Busbar clamp	ACCE 7666
Sealable cover	ACCE 7668

### Customized product

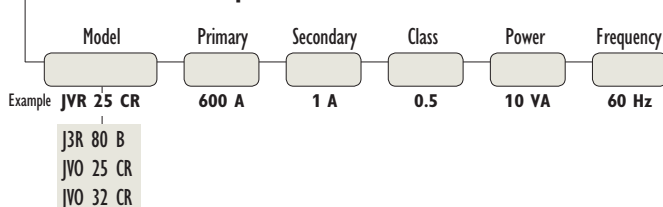

### Associated products

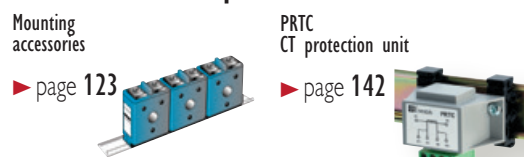

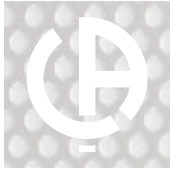

# JVR-JVO-JVP Ranges

JVP – Busbar primary

Current transformers (CTs)

Measurement and instrumentation

## JVP 624

Bar: 63 x 20 mm

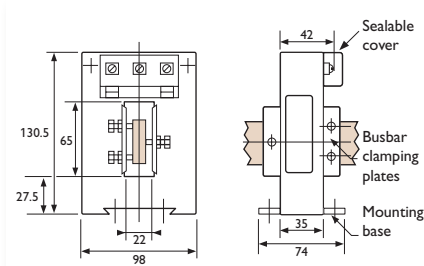

Primary	Power (VA) class			Weight (kg)
	0.5	1	3	
100 A	-	-	5	1.2
125 A	-	-	5	1.2
150 A	-	-	5	1.2
200 A	-	-	5	1.2
250 A	-	5	15	1.2
300 A	-	5	15	1.2
400 A	*	10	15	1.2
500 A	*	15	20	1.2
600 A	*	20	20	1.2
750 A	*	20	20	1.2
800 A	*	20	20	1.2
1000 A	*	20	20	1.2

\*On request

## JVP 1025

Bar: 100 x 20 mm

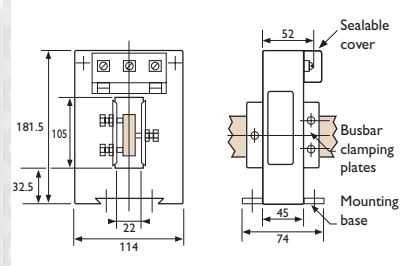

Primary	Power (VA) class			Weight (kg)
	0.5	1	3	
200 A	-	-	5	2
250 A	-	-	5	2
300 A	-	10	20	2
400 A	*	5	30	2
500 A	*	15	15	2
600 A	*	15	15	2
750 A	*	20	20	2
800 A	*	20	30	2
1000 A	*	30	30	2
1250 A	*	30	30	2
1500 A	*	30	30	2
2000 A	*	30	30	2
2500 A	*	30	30	2
3000 A	*	30	30	2

\*On request

## JVP 1045

Bar: 100 x 40 mm

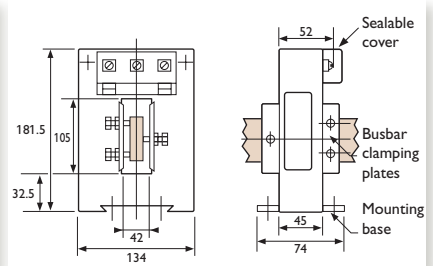

Primary	Power (VA) class			Weight (kg)
	0.5	1	3	
300 A	-	5	5	2.5
400 A	*	5	10	2.5
500 A	*	10	15	2.5
600 A	*	15	15	2.5
750 A	*	20	20	2.5
800 A	*	20	20	2.5
1000 A	*	30	30	2.5
1250 A	*	30	30	2.5
1500 A	*	30	30	2.5
2000 A	*	30	30	2.5
2500 A	*	30	30	2.5
3000 A	*	30	30	2.5

\*On request

### TO ORDER

Primary	Secondary 5 A
100 A	JVPR 8879
125 A	JVPR 8880
150 A	JVPR 8881
200 A	JVPR 8882
250 A	JVPR 8883
300 A	JVPR 8884
400 A	JVPR 8885
500 A	JVPR 8886
600 A	JVPR 8887
750 A	JVPR 8888
800 A	JVPR 8890
1000 A	JVPR 8889
Mounting base	ACCE 7669
Sealable cover	ACCE 7672

Primary	Secondary 5 A
200 A	JVPT 8890
250 A	JVPT 8891
300 A	JVPT 8892
400 A	JVPT 8893
500 A	JVPT 8896
600 A	JVPT 8897
750 A	JVPT 8898
800 A	JVPT 8895
1000 A	JVPT 8899
1250 A	JVPT 8900
1500 A	JVPT 8901
2000 A	JVPT 8902
2500 A	JVPT 8921
3000 A	JVPT 8922
Mounting base	ACCE 7669
Sealable cover	ACCE 7672

Primary	Secondary 5 A
300 A	JVPU 8906
400 A	JVPU 8918
500 A	JVPU 8907
600 A	JVPU 8908
750 A	JVPU 8909
800 A	JVPU 8919
1000 A	JVPU 8910
1250 A	JVPU 8911
1500 A	JVPU 8912
2000 A	JVPU 8913
2500 A	JVPU 8920
3000 A	JVPU 8914
Mounting base	ACCE 7669
Sealable cover	ACCE 7672

### Customized product

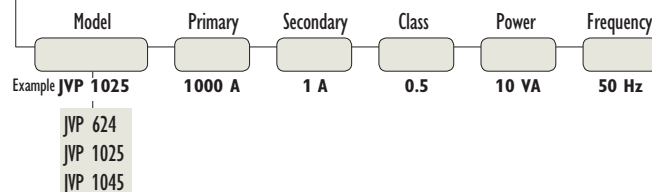

### Associated products

PRTC  
CT protection unit

page 143





# JVS Range

CTs designed to supply electronic measurement instruments, power monitors, digital transducers, etc.

## PRODUCT ADVANTAGES

**+ CHOICE OF PRIMARY**  
from 100 to 5,000 A

**+ ACCURACY CLASS:**  
0.2 S for high-performance applications

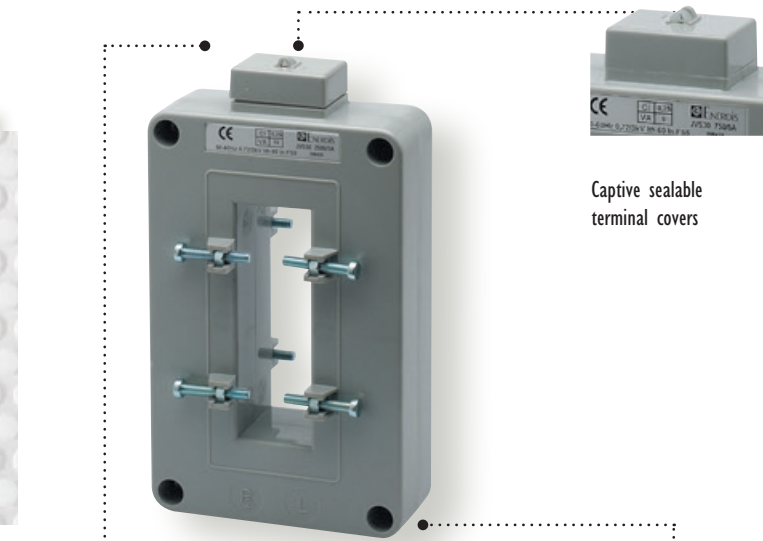

Captive sealable terminal covers



Split output terminals enabling risk-free short-circuiting of the secondary current (M4 or cage for 4 mm<sup>2</sup> wire)



Cabinet base fitting (or directly on busbar primary)

## ► General specifications

**Reference standard:** EN 60044-1 (ex IEC 185)

**Maximum network voltage:** 720 Vac

**Dielectric test voltage:** 3 kV/50 Hz/1 min

**Frequency response:** 50/60 Hz  
**Short-circuit thermal current (I<sub>th</sub>):** 60 I<sub>n</sub> - 1 second

**Dynamic current (I<sub>dyn</sub>):** 2.5 I<sub>th</sub>

**Safety factor:** < 5

**Operating conditions:**  
Temperature: -10°C to +50°C  
Relative humidity: < 90%

**Protection:**  
Protection rating: IP 50 (terminal covers supplied)  
Dry winding with self-extinguishing ABS covering (UL 94 VO)

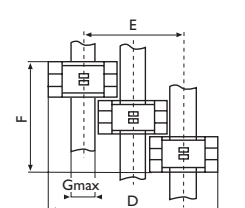
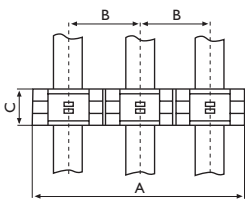

## ► 3CT Mounting

Model	Dimensions						
	A	B	C	D	E	F	G
JVS 25B	243.5	81.5	60.5	189	108.5	183.5	26
JVS 26B	243.5	81.5	60.5	191	110.5	183.5	28
JVS 30B	308	103	69	250	148	209	44
JVS 38B	392	131	69	325	195	209	63
JVS 40	287	96	40	215	120	122	23
JVS 50	347	116	44	264	149	134	32
JVS 60	374	125	44	310	186	134	60

## ► Mounting accessories

Model	Plate mounting fittings	Busbar clamp	Sealable terminal cover*
JVS 25B	•	•	1923 0022
JVS 26B	•	•	1923 0022
JVS 30B	•	•	1923 0022
JVS 38B	•	•	1923 0022
JVS 39B	•	•	1923 0022
JVS 40	•	•	•
JVS 50	•	•	•
JVS 60	•	•	•

• Standard accessories

\* sold in pairs





# JVS Range

Cable/busbar primary

Current transformers (CTs)

▶ Measurement and instrumentation

## JVS 25B

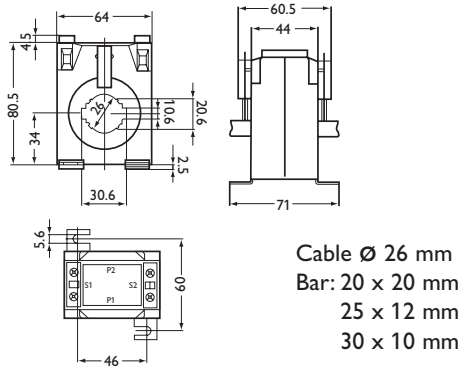

Primary	Power (VA) in class 0.2 S	Weight (kg)
100 A	1	0.53
150 A	2.5	0.53
200 A	3.5	0.54
250 A	5	0.54
300 A	5	0.51
400 A	7.5	0.51

## JVS 26B

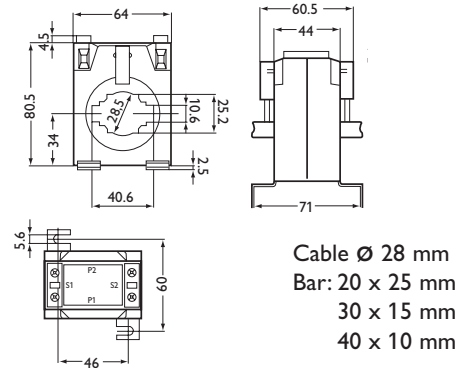

Primary	Power (VA) in class 0.2 S	Weight (kg)
150 A	1	0.37
200 A	1.25	0.38
250 A	1.5	0.39
300 A	1.75	0.4
400 A	1	0.41
500 A	5	0.41
600 A	5	0.42
750 A	7.5	0.43
800 A	7.5	0.44

### TO ORDER

Primary	Secondary 5 A
100 A	JVSB25 100/5
150 A	JVSB25 150/5
200 A	JVSB25 200/5
250 A	JVSB25 250/5
300 A	JVSB25 300/5
400 A	JVSB25 400/5

Primary	Secondary 5 A
150 A	JVSB26 100/5
200 A	JVSB26 200/5
250 A	JVSB26 250/5
300 A	JVSB26 300/5
400 A	JVSB26 400/5
500 A	JVSB26 500/5
600 A	JVSB26 600/5
750 A	JVSB26 750/5
800 A	JVSB26 800/5

### ▶ Associated products

Mounting accessories

▶ page 129



PRTC  
CT protection unit

▶ page 142



# JVS Range

Cable/busbar primary

## JVS 30B

Cable  $\varnothing$  44 mm  
Bar: 50 x 30 mm  
60 x 12 mm

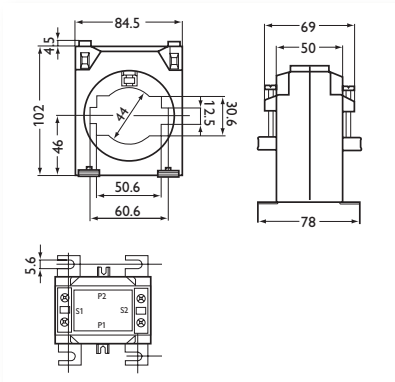

Primary	Power (VA) Class 0.2 S	Weight (kg)
600 A	5	0.52
750 A	7.5	0.59
800 A	7.5	0.60
1000 A	10	0.61
1200 A	10	0.63
1500 A	10	0.65

## JVS 38B

Cable  $\varnothing$  63 mm  
Bar: 50 x 50 mm  
60 x 30 mm  
80 x 30 mm

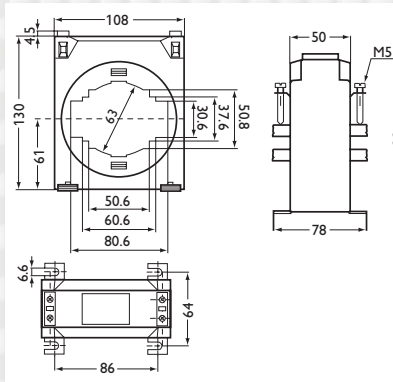

Primary	Power (VA) Class 0.2 S	Weight (kg)
1000 A	7.5	0.72
1200 A	10	0.68
1500 A	10	0.84
2000 A	10	0.82
2500 A	10	0.88
3000 A	10	0.88

## JVS 39B

Bar: 3 x 100 x 10 mm

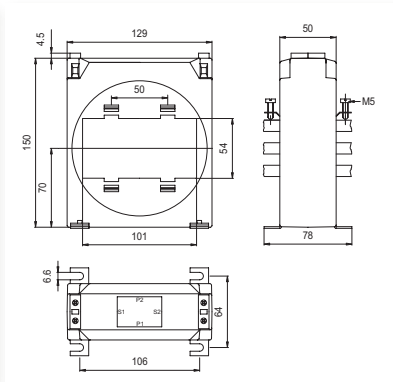

Primary	Power (VA) Class 0.2 S	Weight (kg)
1500 A	10	1.47
2000 A	10	1.55
2500 A	15	1.63
3000 A	20	1.71
4000 A	25	1.83

### TO ORDER

Primary	Secondary 5 A
600 A	JVSB30 600/5
750 A	JVSB30 750/5
800 A	JVSB30 800/5
1000 A	JVSB30 1000/5
1200 A	JVSB30 1200/5
1500 A	JVSB30 1500/5

Primary	Secondary 5 A
1000 A	JVSB38 1000/5
1200 A	JVSB38 1200/5
1500 A	JVSB38 1500/5
2000 A	JVSB38 2000/5
2500 A	JVSB38 2500/5
3000 A	JVSB38 3000/5

Primary	Secondary 5 A
1500 A	JVSB39 1500/5
2000 A	JVSB39 2000/5
2500 A	JVSB39 2500/5
3000 A	JVSB39 3000/5
4000 A	JVSB39 4000/5

### Associated products

Mounting accessories

► page 129



PRTC CT protection unit

► page 142





# JVS Range

Busbar primary

Current transformers (CTs)

Measurement and instrumentation

## JVS 40

Bar: 100 x 20 mm

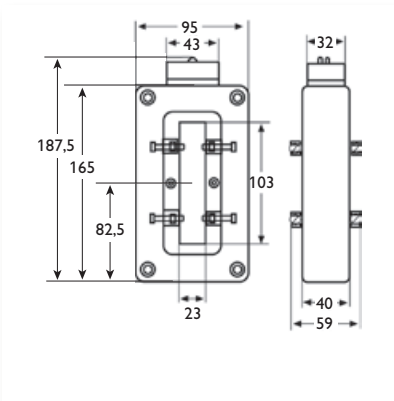

Primary	Power (VA) Class 0.2 S	Weight (kg)
1000 A	1.5	0,76
1200 A	4	0,76
1500 A	10	0,76
2000 A	10	0,76

## JVS 50

Bar: 100 x 30 mm

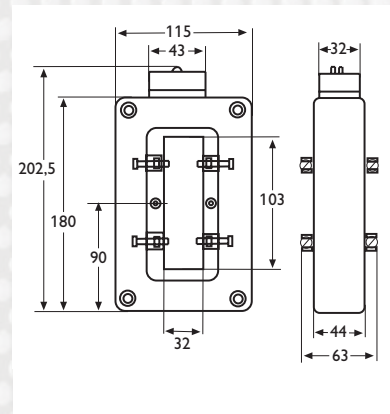

Primary	Power (VA) Class 0.2 S	Weight (kg)
1500 A	10	0,76
2000 A	10	0,82
2500 A	10	0,78
3000 A	10	0,90
4000 A	10	0,90

### TO ORDER

Primary	Secondary 5 A
1000 A	JVS40-1000/5
1200 A	JVS40-1200/5
1500 A	JVS40-1500/5
2000 A	JVS40-2000/5

Primary	Secondary 5 A
1500 A	JVSS0-1500/5
2000 A	JVSS0-2000/5
2500 A	JVSS0-2500/5
3000 A	JVSS0-3000/5
4000 A	JVSS0-4000/5

### Associated products

PRTC  
CT protection unit

▶ page 142



# JVS 60

Bar: 125 x 60 mm

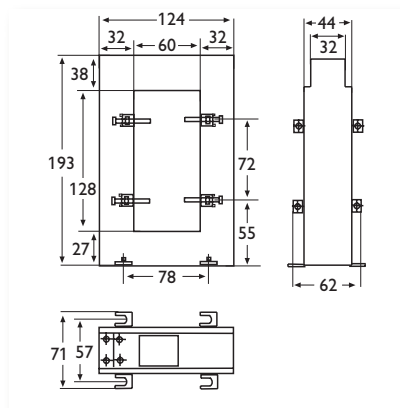

Primary	Power (VA) Class 0.2 S	Weight (kg)
1000 A	1.5	0.75
1500 A	7.5	0.83
2000 A	10	0.92
2500 A	10	1.01
3000 A	10	1.09
4000 A	10	1.21
5000 A	10	1.44

## TO ORDER

Primary	Secondary 5 A
1000 A	JVS60-1000/5
1500 A	JVS60-1500/5
2000 A	JVS60-2000/5
2500 A	JVS60-2500/5
3000 A	JVS60-3000/5
4000 A	JVS60-4000/5
5000 A	JVS60-5000/5

## ► Associated products

PRTC  
CT protection unit

► page 142



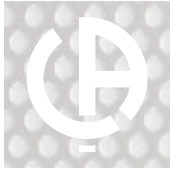

# Single-phase, single-rating: **JVP1045 B**

Transformers for tariff metering

Current transformers (CTs)

## JVP1045 B

Busbar primary

### PRODUCT ADVANTAGES

- +** **DELIVERED WITH SEALABLE PROTECTIVE COVER** for the secondary. Simple M5 terminals
- +** **DIRECT MOUNTING** on primary busbar by means of plate and tightening screw or panel mounting with mounting plate



### ► General specifications

**Reference standard:**  
EN 60044-1 (ex-IEC 185)  
and NFC 42-502

**Maximum network voltage:**  
720 Vac

**Dielectric test voltage:**  
3 kV/50 Hz/1 min

**Frequency response:**  
50/60 Hz

**Thermal short-circuit current (I<sub>th</sub>):** 80 In

**Dynamic current (I<sub>dyn</sub>):**  
2.5 I<sub>th</sub>

**Safety factor:**

10 in class 0.5  
Except \* SF = 6.4/10.5  
and \*\*SF = 4.7/8.2

**Operating conditions:**

Temperature: -20°C to +60°C  
Relative humidity: 93% to 40°C

**Protection:**

Protection rating: IP 50  
Dry winding in self-extinguishing ABS envelope (UL 94 VO)

► Measurement and instrumentation

### TO ORDER

	Power (VA) in class 0.5		Weight (kg)
	7.5	15	
Primary	Secondary 5 A		
500 A		JVPA 7569	2.50
1000 A		JVPA 7573	2.50
2000 A		JVPA 7576	2.50
500-1000 A*	JVPA 7589	JVPA 7585	2.50
1000-2000 A**	JVPA 7590	JVPA 7588	2.50

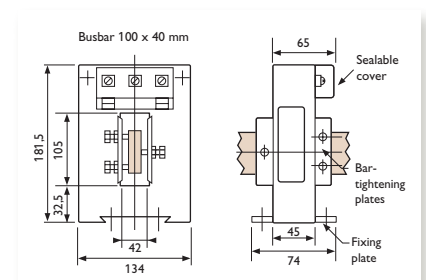

# Single-phase, single-rating: **JVO 40-100**

Transformers for tariff metering

## JVO 40-100

Cable primary

### PRODUCT ADVANTAGES

- + DELIVERED WITH SEALABLE TERMINAL COVER** for the secondary. Simple M5 terminals with two grooves for double connection
- + MOUNTING ON SYMMETRICAL MOUNTING RAIL** or panel mounting



### ► General specifications

**Reference standard:**  
EN 60044-1 (ex-IEC185) and NFC 42-502

**Maximum network voltage:**  
720 Vac

**Dielectric test voltage:**  
3 kV/50 Hz/1 min

**Frequency response:**  
50/60 Hz

**Thermal short-circuit current (I<sub>th</sub>):** 80 In

**Dynamic current (I<sub>dyn</sub>):** 2.5 I<sub>th</sub>

**Safety factor:**  
10 in class 0.5  
Except \* SF = 6.4/10.5  
and \*\*SF = 4.7/8.2

**Operating conditions:**  
Temperature: -5 °C to +50 °C  
Relative humidity: 93 % to 40 °C

**Protection:**  
Protection rating: IP 50  
Dry winding in self-extinguishing ABS envelope (UL 94 VO)

### TO ORDER

	Power (VA) in class 0.5			Weight (kg)
	15	7.5	15	
Primary Secondary	2.5 A	5 A	5 A	
200 A	JVON 7103		JVON 7100	0.97
500 A				0.97
200-500	JVON 7104		JVON 7102	0.97
1-CT mounting rail	ACCE 7679			
2-CT mounting rail	ACCE 7680			
3-CT mounting rail	ACCE 7681			

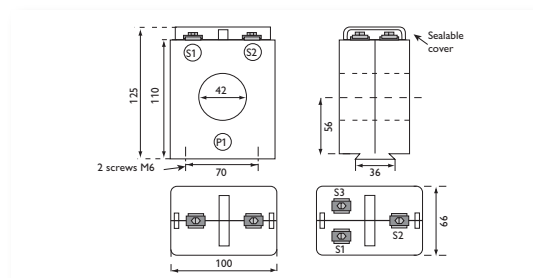





# Single-phase, multi-rating: **JVO 40-100 S**

Transformers for tariff metering – ERDF application

Current transformers (CTs)  
Measurement and instrumentation

## JVO 40-100 S

Cable primary Ø 40 mm



### ► General specifications

**Cable primary:** Ø 40 mm  
**Transformation ratio:**  
 200 - 500 / 5 A  
**Accuracy class:** 0.2s  
**Precision power:** 7.5 VA  
**Highest network voltage:** 720 Vac  
**Rated frequency:** 50/60 Hz  
**Rated short-circuit thermal current (I<sub>th</sub>):** 20 kA for 1 s  
**Rated dynamic current (I<sub>dyn</sub>):** 2.5 I<sub>th</sub>  
**Safety factor:**  
 SF = 3 (200/5 A); SF = 6 (500/5 A)  
**Rated thermal current:** 1.2 I<sub>pn</sub>  
**Operating temperature:**  
 -25°C to +40°C

**Type of casing:**  
 Self-extinguishing thermoplastic (UL94V0)  
**Protection:** IP30  
**Mechanical shock resistance:** IK7  
**Rated withstand voltage:**  
 3 kV (RMS value) at 50 Hz for 1 minute  
**Rated lightning impulse withstand voltage:**  
 8 kV (peak value) – Wave 1.2/50 µs  
**Insulation class:**  
 E (heating limit: 75 K)  
**Weight:** 1.1 kg

### TO ORDER

Model	Reference
JVO 40-100 S bi-rating	P01379512

### ► Dimensions

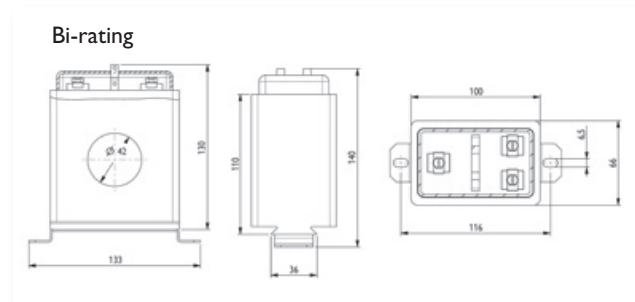

# Single-phase, multi-rating: **JVO 90-160 S**

Transformers for tariff metering – ERDF application

## JVO 90-160 S

Cable primary  $\varnothing$  90 mm

### PRODUCT ADVANTAGES

**+** CLASS 0.2s  
ACCORDING TO  
IEC 60044-1  
Particularly **SUITABLE**  
FOR ERDF-QUALIFIED  
**TRI-RATING**  
ELECTRONIC METERS



### ► General specifications

**Cable primary:**  $\varnothing$  90 mm  
**Transformation ratio:**  
500-1,000-2,000/5 A  
**Accuracy class:** 0.2s  
**Precision power:** 7.5 VA  
**Highest network voltage:** 720 Vac  
**Rated frequency:** 50/60 Hz  
**Rated short-circuit thermal current (I<sub>th</sub>):** 30 kA for 1 s  
**Rated dynamic current (I<sub>dyn</sub>):** 2.5 I<sub>th</sub>  
**Safety factor:**  
SF = 4 (500/5 A); SF = 6 (1 000/5 A) ;  
SF = 9 (2 000/5 A)  
**Rated thermal current:** 1.2 I<sub>pn</sub>  
**Operating temperature:**  
-25°C to +40°C

**Type of casing:**  
Self-extinguishing thermoplastic (UL94V0)  
**Protection:** IP30  
**Mechanical shock resistance:** IK7  
**Rated withstand voltage:**  
3 kV (RMS value) at 50 Hz for 1 minute  
**Rated lightning impulse withstand voltage:**  
8 kV (peak value) – Wave 1.2/50  $\mu$ s  
**Insulation class:** E(heating limit: 75 K)  
**Weight:** 1.9 kg

### TO ORDER

Model	Reference
JVO 90-160 S tri-rating	P01379513

### ► Dimensions

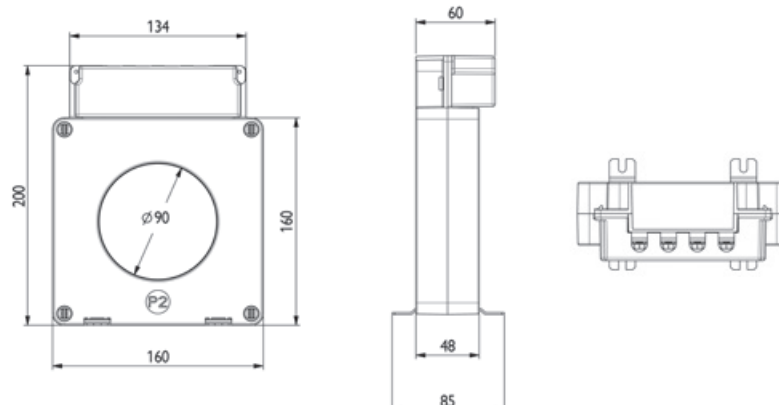



# Single-phase, multi-rating: **JVP 1145 S**

Transformers for tariff metering – ERDF application

Current transformers (CTs)

Measurement and instrumentation

## JVP 1145 S

Cable/busbar primary

### PRODUCT ADVANTAGES

**+** CLASS 0.2s  
ACCORDING TO  
IEC 60044-1  
Particularly **SUITABLE**  
FOR ERDF-QUALIFIED  
**TRI-RATING**  
ELECTRONIC METERS



### ► General specifications

**Cable primary:**  
Busbar: 63 x 12 mm or 100 x 12 mm  
**Cable:** Ø 40 mm  
**Transformation ratio:**  
500 – 1,000 – 2,000 / 5 A  
**Accuracy class:** 0.2s  
**Precision power:** 7.5 VA  
**Highest network voltage:** 720 Vac  
**Rated frequency:** 50/60 Hz  
**Rated short-circuit thermal current (I<sub>th</sub>):** 30 kA for 1 s  
**Rated dynamic current (I<sub>dyn</sub>):** 2.5 I<sub>th</sub>  
**Safety factor:**  
SF = 3 (500/5 A); SF = 4 (1000/5 A);  
SF = 6 (2000/5 A)  
**Rated thermal current:** 1.2 I<sub>pn</sub>

**Operating temperature:**  
-25°C to +40°C  
**Type of casing:**  
Self-extinguishing thermoplastic (UL94V0)  
**Protection:** IP30  
**Mechanical shock resistance:** IK7  
**Rated withstand voltage:**  
3 kV (RMS value) at 50 Hz for 1 minute  
**Rated lightning impulse withstand voltage:**  
8 kV (peak value) – Wave 1.2/50 µs  
**Insulation class:** E (heating limit: 75 K)  
**Weight:** 1.7 kg

### TO ORDER

Model	Reference
JVP 1145 S tri-rating	P01379510

### ► Dimensions

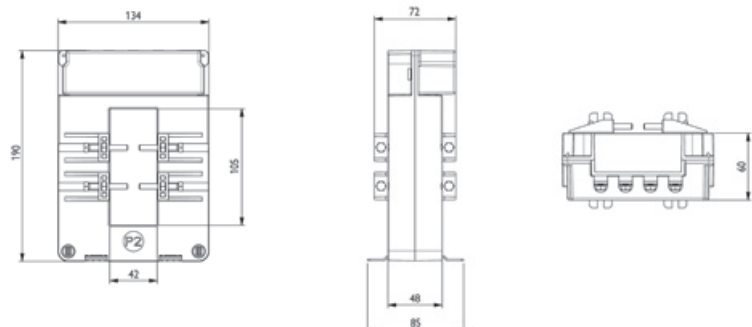

# Single-phase, multi-rating: TRI 500

Transformers for tariff metering

## TRI 500

### PRODUCT ADVANTAGES

- +** COMPLIANT with NF-C-42-502 standard
- +** DESIGNED FOR THREE-PHASE LV METERING

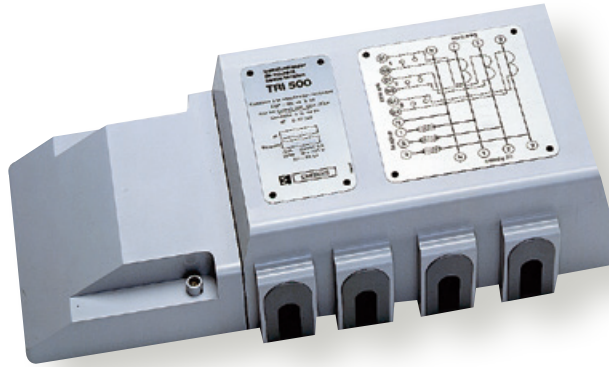

### ► General specifications

- Maximum network voltage:** 500 Vac
- Dielectric test voltage:** 2 kV - 50 Hz - 1 min
- Rated withstand voltage:** 8 kV
- Frequency response:** 50 Hz
- Primary via cable clamp:** conductors from 50 to 240 mm<sup>2</sup>

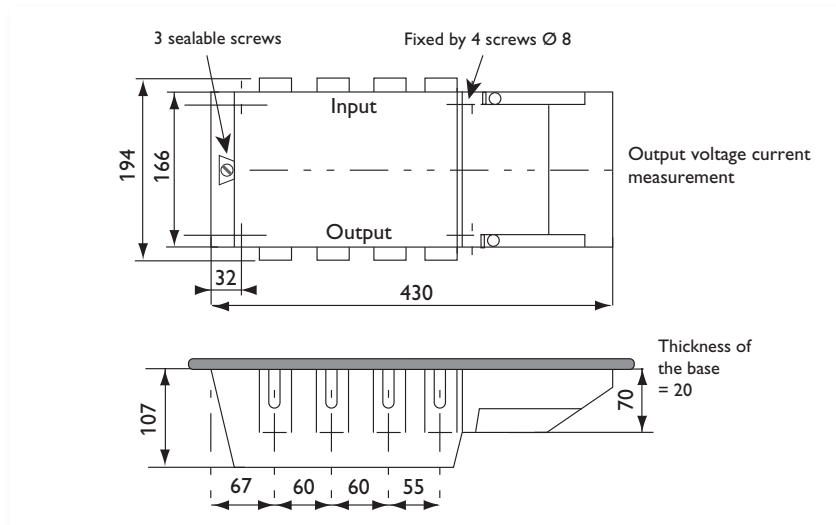

### TO ORDER

Primary	Power (VA) Class 0.5	Weight (kg)
50 A	15	7.50
100 A	15	7.50
150 A	15	7.50
200 A	15	7.50
300 A	15	7.50
500 A	15	7.50

Primary	5 A Secondary
50 A	TRIS 7823
100 A	TRIS 7825
150 A	TRIS 7826
200 A	TRIS 7827
300 A	TRIS 7828
500 A	TRIS 7831



# Three-phase, multi-rating: **TRI 700**

Transformers for tariff metering – ERDF application

Measurement and instrumentation **Current transformers (CTs)**

**PRODUCT ADVANTAGES**

- +** CLASS 0.2S ACCORDING TO IEC 60044-1
- +** CHOICE OF PRIMARY CONDUCTOR type: copper or aluminium
- +** Built-in short-circuiting switch



## ► General specifications

### Primary via cable clamp:

Conductor cross-section from 50 mm<sup>2</sup> to 240 mm<sup>2</sup>

### Transformation ratio:

TRI700S bi-rating model 50 A - 100 A / 5 A  
 TRI700S bi-rating model 100 A - 200 A / 5 A  
 TRI700S bi-rating model 200 A - 500 A / 5 A  
 TRI700 tri-rating model 100 A - 200 A - 500 A / 5 A

### Accuracy class:

Bi-rating model 0.2s; tri-rating model: 0.5

### Precision power:

Bi-rating model: 7.5 VA; tri-rating model: 3.75 VA

### Maximum network voltage:

Bi-rating / tri-rating model: 720 Vac

### Rated frequency:

Bi-rating / tri-rating model: 50/60 Hz

### Rated thermal short-circuit current (I<sub>th</sub>):

Bi-rating / tri-rating model:  
 80 I<sub>pn</sub> with a maximum of 20 kA for 1 s

### Rated dynamic current (I<sub>dyn</sub>):

Bi-rating / tri-rating model: 2.5 I<sub>th</sub>

### Safety factor:

TRI700S 50 - 100 / 5 A:  
 FS = 2.3 (50 A); FS = 4.2 (100 A)  
 TRI700S 100-200/5 A:  
 FS = 2.3 (100 A); FS = 4.2 (200 A)  
 TRI700S 200 - 500 / 5 A:  
 FS = 2,3 (200 A); FS = 5 (500 A)  
 TRI700 100 - 200 - 500 / 5 A:  
 FS = 4 (100 A); FS = 7 (200 A); FS = 10 (500 A)

### Rated thermal current:

Bi-rating / tri-rating model: 1.2 I<sub>pn</sub>

### Operating temperature:

Bi-rating / tri-rating model: -25°C to +40°C

### Type of casing:

Bi-rating / tri-rating model:  
 Self-extinguishing thermoplastic (UL94V0)

### Protection rating:

With additional cover: IP40

### Mechanical shock resistance:

Bi-rating / tri-rating model: (IK7)

### Rated withstand voltage:

Bi-rating / tri-rating model: 3 kV  
 (RMS value) at 50 Hz for 1 minute

### Lightning impulse withstand voltage:

Bi-rating / tri-rating model:  
 (8 kV) (peak value) – Wave 1.2/50 μs

### Insulation class:

Bi-rating / tri-rating model:  
 E (heating limit: 75 K)

**Weight:** Bi-rating / tri-rating model: 9 Kg

## TO ORDER

Model	Reference
TRI 700 tri-rating	P01379514
TRI 700 S bi-rating 50 - 100 / 5 A	P01379515
TRI 700 S bi-rating 100 - 200 / 5 A	P01379516
TRI 700 S bi-rating 200 - 500 / 5 A	P01379517

## ► Dimensions

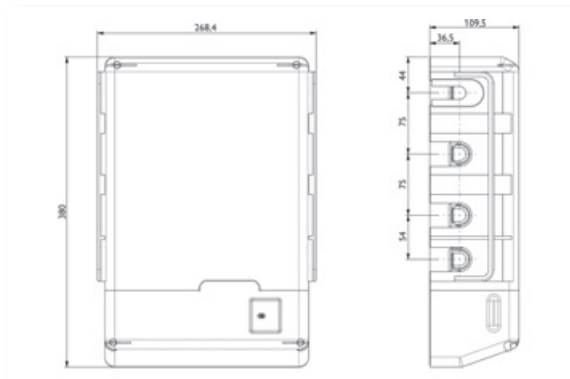



# Current summation: JVM 15

CT designed for adding or subtracting instantaneous values from the secondaries of 2 or 3 current transformers. Used to supply measuring or metering instruments on installations with several feeder and feed points.

**PRODUCT ADVANTAGES**

- + COMPACT DESIGN
- + Mounting on plate or rail



Sealable cover.  
Terminal connections:  
M5; 2 secondary slots  
for double connections;  
primary side connections.

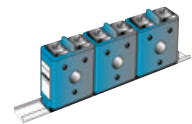

Mounting on plate or  
symmetrical rail

## ► General specifications

**Reference standard:**  
EN 60044-1 (Ex IEC 185)  
**Maximum network voltage:** 720 Vac  
**Dielectric test voltage:**  
3 kV/50 Hz/1 min  
**Frequency response:** 50/60 Hz  
**Short-circuit thermal current**  
(I<sub>th</sub>): 80 I<sub>n</sub> - 1 second  
**Dynamic current (I<sub>dyn</sub>):** 2.5 I<sub>th</sub>  
**Safety factor:** < 5  
**Internal power:** 4 VA  
**Operating conditions:**  
Temperature: -5°C to +60°C  
Relative humidity: 93% at 40°C  
**Protection:**  
Protection rating:  
IP 40 (module casing) and IP 10 (terminals)  
Dry winding with self-extinguishing ABS  
covering (UL 94 VO)

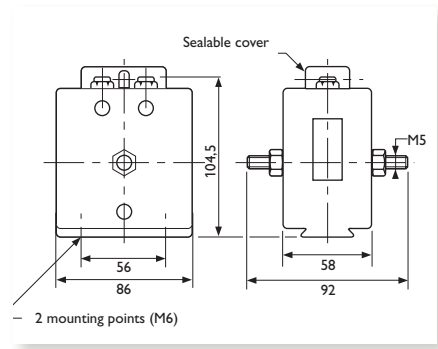

	Power (VA)	class		Weight
Primary	0.5	1	3	(kg)
5+5 A	15	20	30	1.20
5+5+5 A	15	20	30	1.20

## TO ORDER

Primary	Secondary 5 A
5+5 A	JVMA 7523
5+5+5 A	JVMA 7524
Sealable cover	ACCE 7668

## ► Cabinet accessories

Model	1 CT slide rail mounting	2 CT slide rail mounting	3 CT slide rail mounting
JVM 15	ACCE 7652	ACCE 7653	ACCE 7655





# Transformer short-circuit switch

Protection against the dangers caused by opening the secondary circuit on low-voltage measurement CTs

Current transformers (CTs)  
Measurement and instrumentation

## PRODUCT ADVANTAGES

- PROTECTS USERS AND EQUIPMENT AGAINST OVERVOLTAGES** caused by opening the CT 5 A or 1 A secondary
- AUTOMATIC SHORT-CIRCUITING** of CT secondary to which it is permanently connected
- Equipment connected on CT secondary side can be operated by user without supply interruption

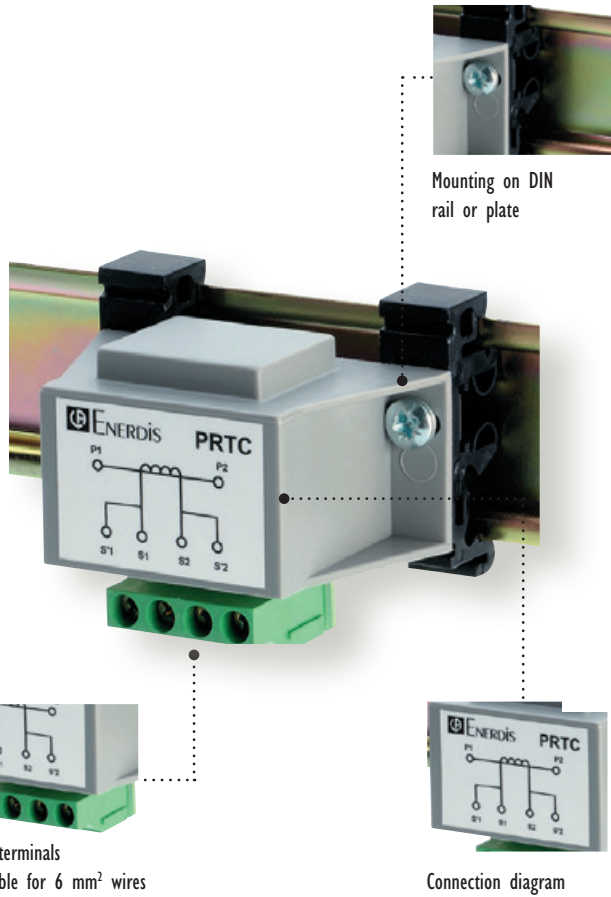

## General specifications

### Reference standards:

NFC 15100 art 411-1)  
Connections: double terminals capable of receiving 6 mm<sup>2</sup> cables. DIN rail mounting (supplied with fittings) or plate mounting using clamp bolts.  
Weight: 90 g

### Operating conditions:

Temperature: -10°C to +50°C  
Relative humidity: < 95%

### Protection:

Protection rating: IP 20  
Self-extinguishing polyamide casing (UL 94VO)  
Measurement current: 5 A/50 Hz or 1 A/50 Hz  
Maximum permitted current: 25 Aac  
Peak voltage: 22 Vac

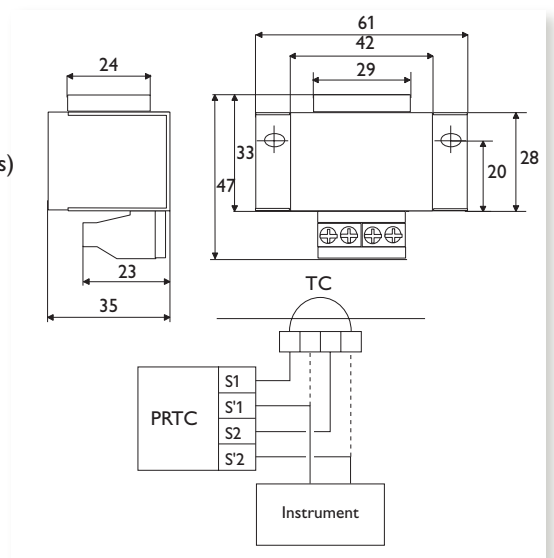

TO ORDER

Reference





PRTC 1001

# Notes

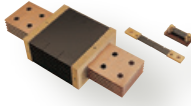

# Choosing your shunt

Shunts  
 Measurement and instrumentation

	76-2 and 77-2			SHMI			SHEL	SHMO
	▶ page 145			▶ page 147			▶ page 149	▶ page 150
								
Type	76-2	76-2	77-2	SHMI	SHMI	SHMI	SHEL	SHMO
Type	Eye connection on base	Eye connection	Plate connection for busbar	Screw connection	Eye connection	Connection to block for busbar	Direct connection to measuring component	Modular casing
Voltage drop	100 mV							
Accuracy class	0.2 and 0.5			0.5 and 1			1	
1 A								
1.25 A								
1.5 A								
2 A								
2.5 A								
3 A								
4 A								
5 A								
6 A								
7.5 A								
10 A								
15 A								
20 A								
25 A								
30 A								
40 A								
50 A								
60 A								
75 A								
100 A								
125 A								
150 A								
200 A								
250 A								
300 A								
400 A								
500 A								
600 A								
750 A								
1000 A								
1250 A								
1500 A								
2000 A								
2500 A								
3000 A								
4000 A								
5000 A								
6000 A								
Strengths	High-performance range. High overload capacity. Treated against corrosion.			Range with a good performance/price trade-off. Large choice of voltage drop ratings (on request).			The most economical range.	Range for mounting on DIN 46277 rail.
<b>SPECIFIC PRODUCTS POSSIBLE IN THIS RANGE</b>								

# 76-2 and 77-2 Ranges

A reference for measurements on demanding applications

**PRODUCT  
ADVANTAGES**

- + HIGH-PERFORMANCE  
RANGE**
- + HIGH OVERLOAD  
CAPACITY**

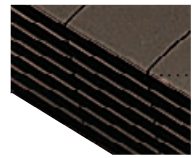
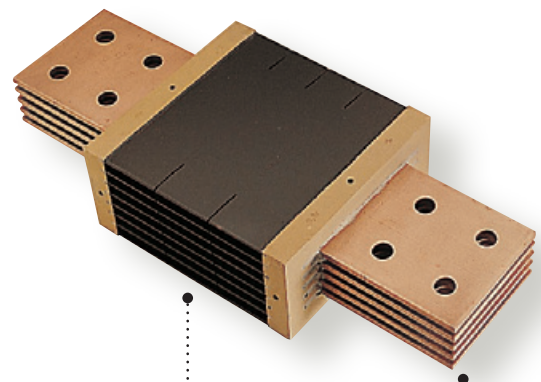

Protection against corrosion with epoxy-modified acrylic paint



Large-area fittings to facilitate heat dissipation

## ► General specifications

**Accuracy class defined in the following domain:**  
Over the whole measurement range, for an ambient temperature of:

- -10°C to +35°C (Class 0.2)
- -25°C to +40°C (Class 0.5 and 1)

For a blade temperature of 80°C  
For a shunt current ≤ 5 mA

**Permitted rated calibres:**  
In = 1 A - 1.25 A - 1.5 A - 2 A - 2.5 A - 3 A - 4 A - 5 A - 6 A - 7.5 A;  
their multiples or sub-multiples

**Voltage drops:**  
50 mV - 60 mV - 100 mV - 150 mV - 200 mV - 300 mV - 1 V

**Permitted overloads:**  
On average and in normal operating conditions

I rated (In)	2 h	5 s Class 0.2	5 s Class 0.5 and 1
< 250 A	1.2 In	2 In	10 In
250 to 2,000 A	1.2 In	2 In	5 In
> 2,000 A	1.2 In	2 In	2 In

**Compliance with standards:**  
Accuracy and influence factor:  
IEC 60051-1 to 9  
Preferred calibres and dimensions for 100 mV shunts:  
NFC 42-151/152/153z  
Lead-free range: RoHS directive (2002/95/CE)





# 76-2 and 77-2 Ranges

Shunts  
Measurement and instrumentation

## 76-2

Eye connection on base

Voltage drop: 100 mV  
Class 0.2 and 0.5

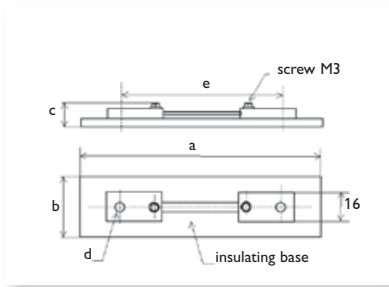

Current	Dimensions (mm)				
	a	b	c	d	e
1 A	150	20	13	6	130
1.25 A	150	20	13	6	130
1.5 A	150	20	13	6	130
2 A	150	20	13	6	130
2.5 A	150	20	13	6	130
3 A	150	20	13	6	130
4 A	150	20	13	6	130
5 A	150	20	13	6	130
6 A	150	20	13	6	130
7.5 A	150	20	13	6	130

## 76-2

Eye connection

Voltage drop: 100 mV  
Class 0.2 and 0.5

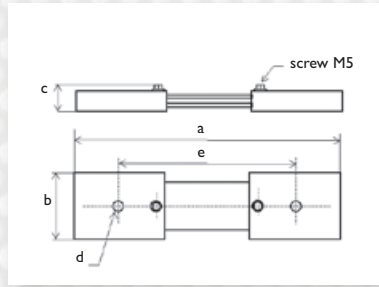

Current	Dimensions (mm)				
	a	b	c	d	e
10 A	160	16	11	6	130
15 A	160	16	11	6	130
20 A	160	16	11	6	130
25 A	160	16	11	6	130
30 A	190	25	11	10	160
40 A	190	25	11	10	160
50 A	190	25	11	10	160
60 A	190	25	11	10	160
75 A	190	25	11	10	160
100 A	190	32	11	10	160
125 A	220	32	13	14	180
150 A	220	32	13	14	180
200 A	220	32	13	14	180
250 A	220	50	13	14	180
300 A	220	50	13	14	180
400 A	240	60	17	18	200
500 A	240	60	17	18	200

## 77-2

Blade connection for bar

Voltage drop: 100 mV  
Class 0.2 and 0.5

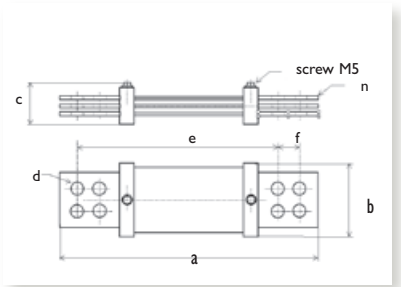

Current	Dimensions (mm)						
	a	b	c	d	e	f	n
600 A	280	80	35	11	220	25	1
750 A	280	80	35	11	220	25	1
1000 A	380	115	35	14	280	50	1
1250 A	380	115	35	14	280	50	1
1500 A	380	115	55	14	280	50	2
2000 A	380	115	55	14	280	50	2
2500 A	400	168	55	14	300	50	3
3000 A	400	168	65	14	300	50	4
4000 A	400	168	85	14	300	50	5

### TO ORDER

Current	Reference for 100 mV	
	Class 0.2	Class 0.5
1 A	SHUN 1200	SHUN 1300
1.25 A	SHUN 1201	SHUN 1301
1.5 A	SHUN 1202	SHUN 1302
2 A	SHUN 1203	SHUN 1303
2.5 A	SHUN 1204	SHUN 1304
3 A	SHUN 1205	SHUN 1305
4 A	SHUN 1206	SHUN 1306
5 A	SHUN 1207	P01 3042 11
6 A	SHUN 1208	SHUN 1308
7.5 A	SHUN 1209	SHUN 1309

Current	Reference for 100 mV	
	Class 0.2	Class 0.5
10 A	SHUN 1210	P01 3042 01
15 A	SHUN 1211	P01 3042 08
20 A	SHUN 1212	P01 3042 02
25 A	SHUN 1213	P01 3042 09
30 A	SHUN 1214	P01 3042 03
40 A	SHUN 1215	P01 3042 10
50 A	SHUN 1216	P01 3042 04
60 A	SHUN 1217	P01 3042 12
75 A	SHUN 1218	P01 3042 13
100 A	SHUN 1219	P01 3042 05
125 A	SHUN 1220	P01 3042 15
150 A	SHUN 1221	P01 3042 16
200 A	SHUN 1222	P01 3042 06
250 A	SHUN 1223	P01 3042 17
300 A	SHUN 1224	P01 3042 07
400 A	SHUN 1225	P01 3042 18
500 A	SHUN 1226	P01 3042 14

Current	Reference for 100 mV	
	Class 0.2	Class 0.5
600 A	SHUN 1227	P01 3042 48
750 A	SHUN 1228	P01 3042 41
1000 A	SHUN 1229	P01 3042 42
1250 A	SHUN 1230	P01 3042 49
1500 A	SHUN 1231	P01 3042 43
2000 A	SHUN 1232	P01 3042 44
2500 A	SHUN 1233	P01 3042 45
3000 A	SHUN 1234	P01 3042 46
4000 A	SHUN 1235	P01 3042 47

### Customized products

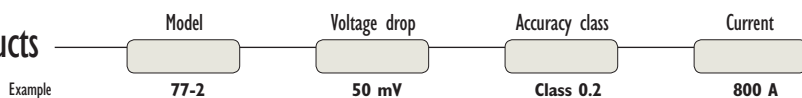

# SHMI Range

Offering a vast range of industrial applications

## PRODUCT ADVANTAGES

- +** Range with excellent **PERFORMANCE/PRICE** trade-off
- +** **A WIDE CHOICE** of voltage drops
- +** **COMPACT DESIGN** that respects accepted thermal dissipation requirements

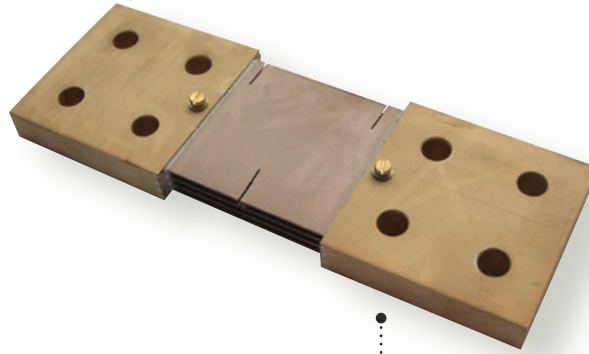

Easy-to-connect brass plates

## ► General specifications

### Accuracy class defined in the following domain:

Over the entire measurement range  
 For an ambient temperature of:  
 -10°C to +35°C (class 0.2)  
 -25°C to +40°C (class 0.5 and 1)  
 For a blade temperature of 80°C  
 For a shunt current  $\leq 5$  mA

### Permitted rated calibres:

$I_n = 1$  A - 1.25 A - 1.5 A - 2 A - 2.5 A - 3 A - 4 A - 5 A - 6 A - 7.5 A  
 and their multiples or sub-multiples

### Permitted overloads:

On average and in normal operating conditions

$I$ nominal ( $I_n$ )	2 h	5 s class 0.2	5 s class 0.5 and 1
< 250 A	1.2 $I_n$	2 $I_n$	10 $I_n$
250 to 2000 A	1.2 $I_n$	2 $I_n$	5 $I_n$
> 2000 A	1.2 $I_n$	2 $I_n$	2 $I_n$

### Voltage drops:

50 mV - 60 mV - 100 mV - 150 mV - 200 mV - 300 mV - 1 V

### Compliance with standards:

Accuracy and influence factor:  
 IEC 60051-1 to 9  
 Preferred ratings and dimensions for 100 mV shunts:  
 NFC 42-151/152/153  
 Lead-free range: RoHS directive (2002/95/CE)

## ► Mounting accessories

Kit of screw connectors + lead for shunt	Reference
1 to 25 A range	2919 9901
30 to 75 A range	2919 9902
100 A range	2919 9903
125 to 200 A range	2919 9904
250 to 500 A range	2919 9905
600 A and 750 A range	2919 9906





# SHMI Range

Shunts  
Measurement and instrumentation

## SHMI

SHMI 1 A to 25 A  
screw connection

Voltage drop: 100 mV  
Class 0.5 and 1

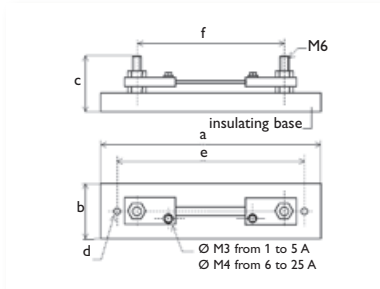

Current	Dimensions (mm)					
	a	b	c	d	e	f
1 A	162	25	40	3.5	152	110
2 A	162	25	40	3.5	152	110
2.5 A	162	25	40	3.5	152	110
3 A	162	25	40	3.5	152	110
4 A	162	25	40	3.5	152	110
5 A	162	25	40	3.5	152	110
6 A	162	25	40	3.5	152	110
7.5 A	162	25	40	3.5	152	110
10 A	162	25	40	3.5	152	110
15 A	162	25	40	3.5	152	110
20 A	162	25	40	3.5	152	110
25 A	162	25	40	3.5	152	110

## SHMI

SHMI 30 A to 750 A  
eye connection

Voltage drop: 100 mV  
Class 0.5 and 1

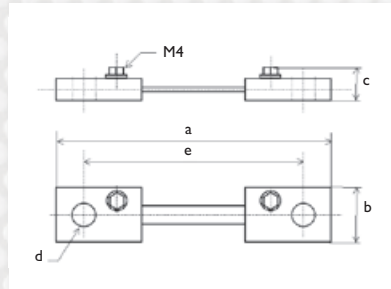

Current	Dimensions (mm)				
	a	b	c	d	e
30 A	150	16	10	8.5	130
40 A	150	16	10	8.5	130
50 A	150	16	10	8.5	130
60 A	150	16	10	8.5	130
75 A	150	16	10	8.5	130
100 A	150	21	10	8.5	130
125 A	150	32	10	8.5	130
150 A	150	32	10	8.5	130
200 A	150	32	14	8.5	130
250 A	210	52	13	14.5	180
300 A	210	52	13	14.5	180
400 A	210	52	17	14.5	180
500 A	210	52	17	14.5	180
600 A	210	52	22	14.5	180
750 A	210	52	22	14.5	180

## SHMI

SHMI 1,000 A to 6,000 A  
busbar connection block

Voltage drop: 100 mV  
Class 0.5 and 1

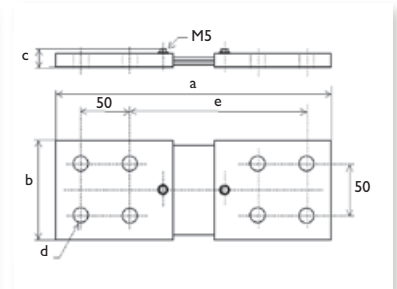

Current	Dimensions (mm)				
	a	b	c	d	e
1000 A	290	100	20	14.5	190
1250 A	290	100	25	14.5	190
1500 A	290	100	25	14.5	190
2000 A	290	100	35	14.5	190
2500 A	290	100	45	14.5	190
3000 A	290	100	45	14.5	190
4000 A	330	150	45	16.5	230
5000 A	330	150	45	16.5	230
6000 A	330	150	45	16.5	230

### TO ORDER

Current	Reference for 100 mV	
	Class 0.5	Class 1
1 A	2901 0301	2901 0101
2 A	2901 0303	2901 0103
2.5 A	2901 0304	2901 0104
3 A	2901 0305	2901 0105
4 A	2901 0306	2901 0106
5 A	2901 0307	2901 0107
6 A	2901 0308	2901 0108
7.5 A	2901 0310	2901 0110
10 A	2901 0312	2901 0112
15 A	2901 0314	2901 0114
20 A	2901 0315	2901 0115
25 A	2901 0316	2901 0116

Current	Reference for 100 mV	
	Class 0.5	Class 1
30 A	2901 0317	2901 0117
40 A	2901 0318	2901 0118
50 A	2901 0319	2901 0119
60 A	2901 0321	2901 0121
75 A	2901 0323	2901 0123
100 A	2901 0325	2901 0125
125 A	2901 0326	2901 0126
150 A	2901 0328	2901 0128
200 A	2901 0330	2901 0130
250 A	2901 0331	2901 0131
300 A	2901 0333	2901 0133
400 A	2901 0335	2901 0135
500 A	2901 0336	2901 0136
600 A	2901 0338	2901 0138
750 A	2901 0340	2901 0140

Current	Reference for 100 mV	
	Class 0.5	Class 1
1000 A	2901 0361	2901 0161
1250 A	2901 0362	2901 0162
1500 A	2901 0363	2901 0163
2000 A	2901 0364	2901 0164
2500 A	2901 0365	2901 0165
3000 A	2901 0366	2901 0166
4000 A	2901 0368	2901 0168
5000 A	2901 0369	2901 0169
6000 A	2901 0370	2901 0170

### Customized products

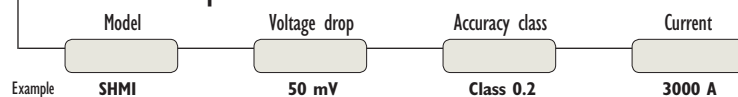

### Associated products

Mounting accessories  
page 147



# SHEL and SHMO Ranges

For simplified installation on low-power networks

## PRODUCT ADVANTAGES

- + ECONOMY RANGE**  
for construction (SHEL)  
and for simplified  
installation (SHMO)
- + DIRECT CONNECTION**  
to measuring component  
(SHEL)
- + MODULAR CASING**  
for quick and easy  
mounting (SHMO)
- + COMPACT DESIGN**  
(SHEL)

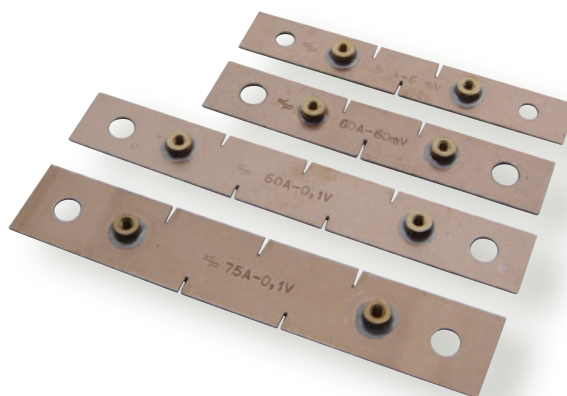

## ► General specifications

### Accuracy class 1 defined in the following domain:

Over the entire measurement range  
For an ambient temperature of  
-25°C to +40°C  
For a blade temperature of 80°C  
For a shunt current  $\leq 5$  mA

### Permitted rated calibres:

$I_n = 1$  A - 1.25 A - 1.5 A - 2 A - 2.5 A -  
3 A - 4 A - 5 A - 6 A - 7.5 A and their  
multiples or sub-multiples  
Max. 300 A for SHEL and 60 A for SHMO

### Permitted rated calibres:

50 mV - 60 mV - 100 mV

### Permitted overloads:

On average and in normal operating  
conditions

$I_{\text{nominal}} (I_n)$	2 h	5 s
$< 250$ A	$1.2 I_n$	$10 I_n$
$\geq 250$ A	$1.2 I_n$	$5 I_n$

### Compliance with standards:

Accuracy and influence factor:  
IEC 60051-1 to 9  
Lead-free range: RoHS directive  
(2002/95/CE)



# SHEL and SHMO Ranges

Shunts

Measurement and instrumentation

## SHEL

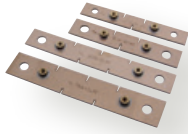

Voltage drop: 100 mV Class 1

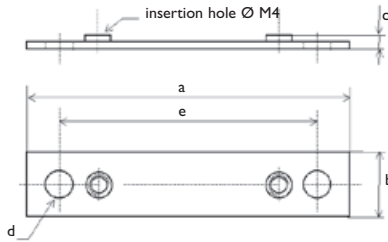

Dimensions (mm)

Current	a	b	c	d	e
10 A	150	10	5	6.5	122
15 A	150	12	5	6.5	122
20 A	150	12	5	6.5	122
25 A	150	15	5	6.5	122
30 A	150	15	5	6.5	122
40 A	150	15	5	6.5	122
50 A	150	20	5	6.5	122
60 A	150	25	5	8.5	122
75 A	150	30	5	8.5	122
100 A	150	20	6	8.5	122
125 A	150	25	6	8.5	122
150 A	150	30	6	8.5	122
200 A	150	40	6	10.5	122
250 A	150	50	6	10.5	122
300 A	150	60	6	10.5	122

TO ORDER

Current	Reference for 100 mV Class 1
10 A	2901 0246
15 A	2901 0247
20 A	2901 0227
25 A	2901 0228
30 A	2901 0229
40 A	2901 0230
50 A	2901 0231
60 A	2901 0232
75 A	2901 0233
100 A	2901 0235
125 A	2901 0236
150 A	2901 0237
200 A	2901 0238
250 A	2901 0239
300 A	2901 0248

## SHMO

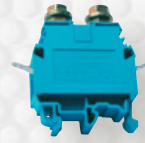

Voltage drop: 100 mV Class 1

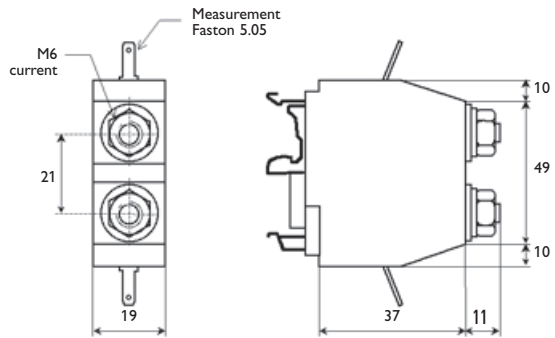

TO ORDER

Current	Reference for 100 mV Class 1
1 A	2925 0101
5 A	2925 0107
10 A	2925 0112
15 A	2925 0114
20 A	2925 0115
25 A	2925 0116
30 A	2925 0117
40 A	2925 0118
50 A	2925 0119
60 A	2925 0121

Customized products

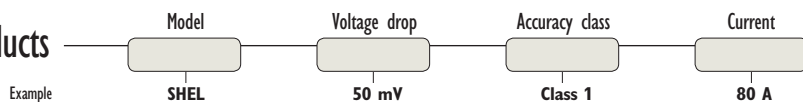

# Notes

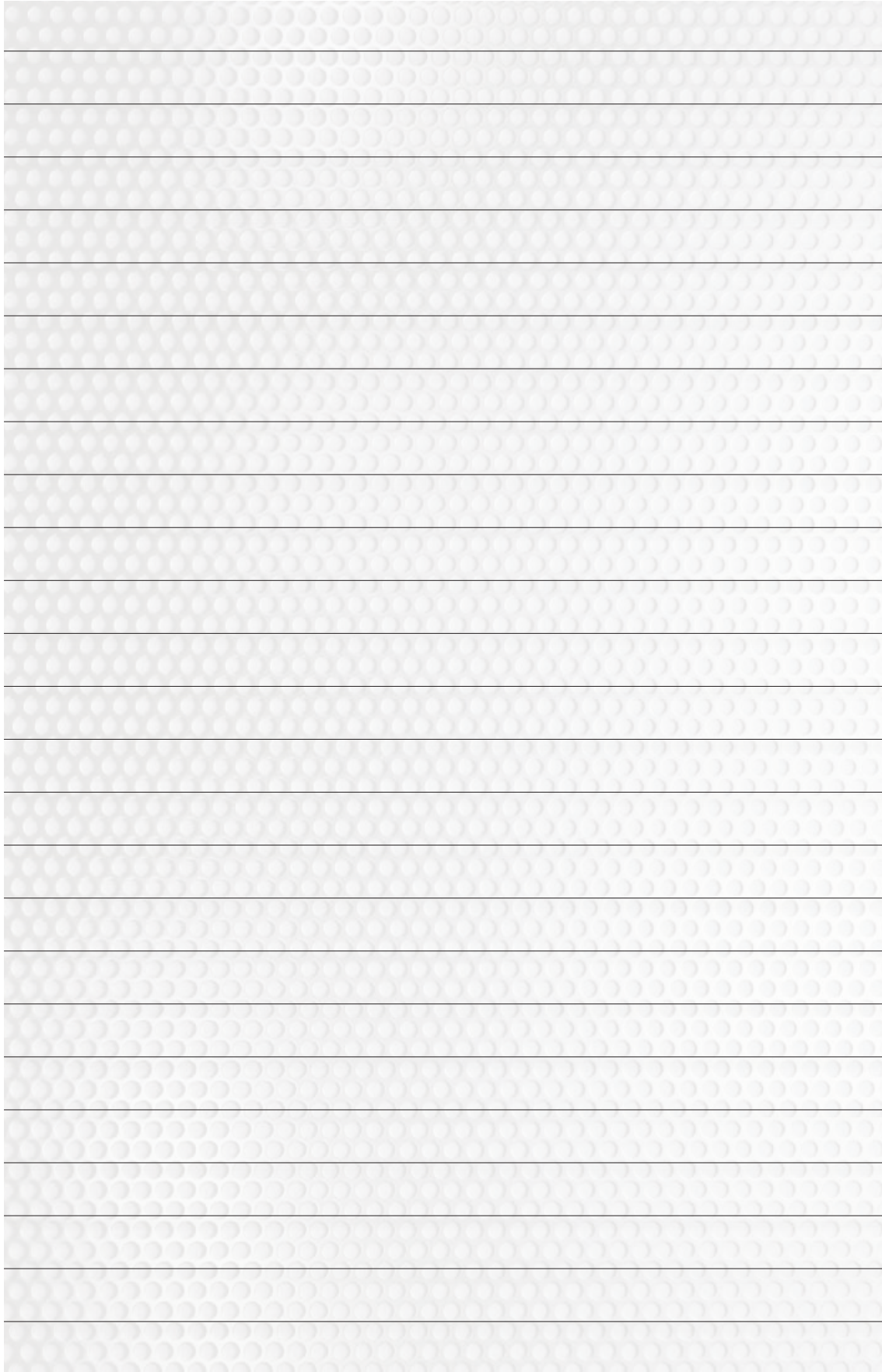





# Transducers

▲ Measurement and instrumentation

**TRIAD 2** - programmable digital transducers  
1, 2, 3 or 4 configurable analogue outputs / Class 0.2  
1 Ethernet or RS485 digital output



Factory-programmed TRIAD 2  
AC quantities  
▶ page 158



TRIAD 2 programmable via TRIADJUST 2  
AC quantities  
▶ page 159

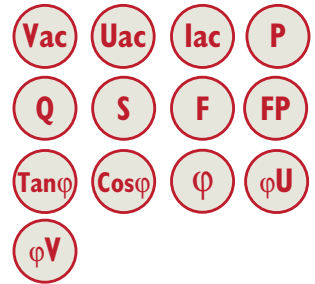

**MICAR 2** - programmable multi-function  
digital transducers  
2 or 4 configurable analogue outputs / Class 0.2  
2 or 4 alarm/pulse outputs  
1 Ethernet or RS485 digital output



Factory-programmed MICAR 2  
AC quantities  
▶ page 174



MICAR 2 programmable via E.view+  
AC quantities  
▶ page 180



## C.A 3420 - universal digital transducer

### 1 configurable analogue input



DC quantities / Physical quantities  
 ▶ page 182



## TSP 2 - self-powered analogue transducers

### 1 analogue output / Class 0.2



TSPU  
 Voltage measurement  
 ▶ page 184



TSPI  
 Current measurement  
 ▶ page 184







Transducers measure AC, DC or physical quantities and transmit them as a standard analogue signal (Vcc or mA).



## FACTORY-PROGRAMMED OR USER-PROGRAMMABLE?



### Factory-programmed

If the specifications of the measurements required are known, a **factory-programmed** transducer can be used.

### User-programmable

If the precise specifications of the measurements are not known, choose a **user-programmable** transducer. You can then program it accordingly when the specifications are known and you can modify the settings if these specifications change.

## WHICH TRANSFER CURVES SHOULD YOU CHOOSE?

Linear

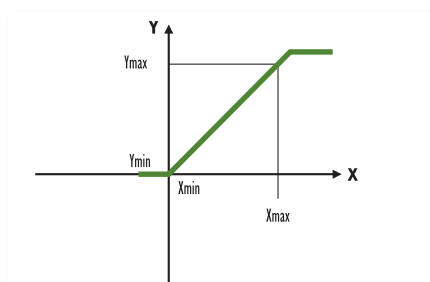

Linear without offset

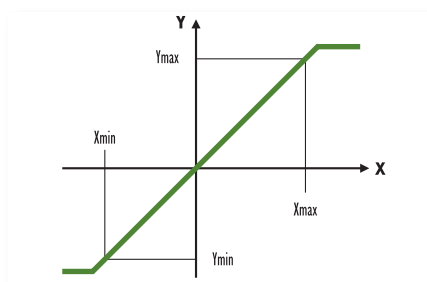

Linear with offset

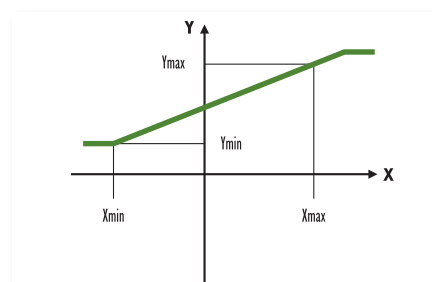

Linear with 2 extended slopes

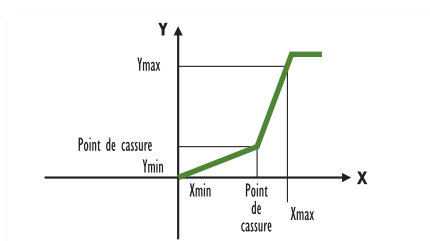

Linear with 2 slopes

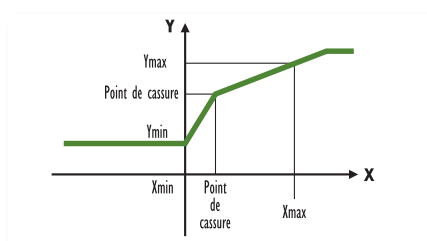

Quadratic

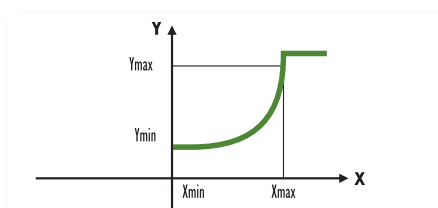

### FOCUS

## Accuracy class and IEC 688 standard

The IEC 688 standard defines the accuracy class as the limits of the intrinsic error expressed as a percentage of the output interval.

Example:

For a measurement range of 0 - 1,000 kW, an output interval of 16 mA (output 4-20 mA) and an accuracy class of 0.2, the intrinsic error is:

$$\frac{0.2}{100} \times 16 \text{ mA} = \pm 0.032 \text{ mA}$$

representing a measurement uncertainty of  $\pm 2$  kW over the complete measurement range 0 - 1,000 kW.



## Advantages of analogue outputs

- ▶ **Universality:** the nature of the output signal from the measurement transducer enables quick and easy connection to a wide range of instruments (recorders, controllers, calculators, analogue and digital panel meters, measurement relays, PLCs, RTUs, etc.).
- ▶ **Response time:** the response time of an analogue output enables real-time viewing of all electrical parameters (for example, SCADA application, dispatching, control and monitoring of industrial processes).
- ▶ **Resistance to disturbances:** analogue signals (current outputs in particular) are not significantly affected by electromagnetic disturbances. A single shielded-pair wire enables you to transmit the output signal over very long distances (several hundred meters without signal amplification).
- ▶ **Reliability:** analogue transducer technology offers the advantage of several decades of application and use, benefiting from wide experience in such varied fields as industry, building automation and electrical network supervision (dispatching).

## Advantages of programmable transducers

The configuration software associated with transducers enables you to adapt transducer specifications to application needs at all times and stages of the application.

- ▶ **Reduction of stocks and maintenance costs**  
A programmable transducer can replace any other product as necessary, helping to reduce stocks for maintenance.
- ▶ **Quickly and easily replaceable products**  
Programmability makes it easy to replace products quickly, thus cutting maintenance time.
- ▶ **Adaptable to installation evolutions**  
The programmable transducer can be modified at all times, especially in the case of modification of initial specifications or information unavailable at the outset.

## Advantages of digital outputs

- ▶ **Remote access for easy maintenance:** with digital outputs, it is possible to create a communicating network so that you can set the products' parameters remotely.
- ▶ **Remote meter-reading:** using the commands available in the ModBus mapping, a transducer can be operated via a digital supervision system and remote-read all the electrical quantities available per product on the same bus.
- ▶ **Extra functions:** the digital outputs on our transducers can be used to access functions which were previously unavailable, such as alarm, date-stamping or energy index functions.

# Selection guide



Measurements					
I <sub>ac</sub>		•	•	•	
V <sub>ac</sub>	•		•	•	
U <sub>ac</sub>	•		•	•	
V <sub>earth</sub>				•	
I <sub>neutral</sub>				•	
I <sub>dc</sub>					•
V <sub>dc</sub>					•
P			•	•	
Q			•	•	
S			•	•	
F			•	•	
PF			•	•	
cosφ			•	•	
Tanφ			•		
φ			•		
φ (U' – U'')			•		
T°					•
Ω					•
kWh				•	
kVAh				•	
kVAh				•	
Options					
Number of analogue outputs	1	1	4	4	1
RS485			•	•	
Ethernet			•	•	
Pulse output				•	
Alarm output				•	
Relay output			•	•	
Programmable			•	•	•
Plug-in versions					
Version Rack					
Self-powered	•	•	(1)	(1)	

(1) By looping the input voltage

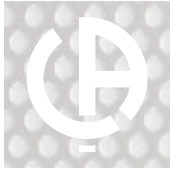

# TRIAD 2 Range

Programmable digital transducers with 1 to 4 analogue outputs  
Programmable accuracy class

Measurement and instrumentation Programmable digital transducers

## PRODUCT ADVANTAGES

- + Up to 4 **PROGRAMMABLE ANALOGUE OUTPUTS**
- + **4 kV INSULATION**
- + **CONFIGURABLE AND MODIFIABLE** using the TRIADJUST 2 software
- + **ADJUSTABLE** accuracy within Class 0.1 as per IEC 60688
- + **ADJUSTABLE RESPONSE TIME** down to 50 ms
- + **DIGITAL OUTPUT** available as an **OPTION**

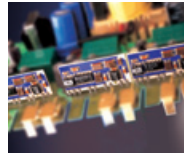

Multi-function, economical instrument with 4 functions in the same casing



Communication, Ethernet RS 485 or optical head



Accessibility and safety: large-dimension terminals  
Insulated circuits



Ergonomic: easy mounting on DIN rail or switchboard

## ► Main specifications

**Quantities measured:** 1, 2, 3, 4 to be chosen from I, V, U, F, FP, P, Q, S,  $\cos\phi$ ,  $\phi$ ,  $\phi U$ ,  $\phi V$ ,  $\tan\phi$

**Configuration of TRIAD 2:** in factory or by the user with the TRIADJUST 2 software

**Accuracy (programmable):** Class 0.1 / 0.15 / 0.2 / 0.5 / 1

**Current inputs:** 1 A, 5 A and 10 A

**Voltage inputs:** 100 to 480 V (ph-ph) or  $100 / \sqrt{3}$  to  $480 / \sqrt{3}$  V (ph-N)

**Transfer curves:** linear, 2 slopes or quadratic

**Output signals:**  $\pm 1$  mA,  $\pm 5$  mA,  $\pm 20$  mA,  $\pm 1$  V,  $\pm 10$  V

**Response time in Class 0.2:** 200 ms

**Operating frequency:** 50 or 60 Hz

**Auxiliary power supply with wide dynamic range:** 80 to 265 V ac/dc or 19 to 58 V dc

**Compliance with CE directive**

**Digital technology**

## TRIAD 2 Programmable model

### ► Factory-programmable

- The transducer delivered is ready to operate and can be connected to the electrical network in order to deliver output signals tailored for your installation.
- To benefit from this, you simply need to know the exact specifications of your electrical installation:
  - Type of network: split-phase, balanced or unbalanced three-phase, 3 or 4 wires.
  - Type of electrical connections.
  - Number of electrical quantities to be measured: 1, 2, 3 or 4.
  - Precise measurement ranges of the input/output quantities to be measured.

Users can modify a factory configuration at any time with the TRIADJUST 2 software if the specifications of the electrical network change.

### ► Programmable via TRIADJUST 2

- With the TRIADJUST 2 software and one of the 3 communication modes available (Ethernet, RS485 or optical head) you can program all the parameters characterizing a TRIAD 2 transducer.
- To do so, simply choose a model which suits your electrical installation:
  - Type of network: split-phase, balanced or unbalanced three-phase, 3 or 4 wires.
  - Number of analogue outputs required (1, 2, 3 or 4).
  - Value of the auxiliary source.
- You are then free to configure the TRIAD 2 transducer delivered as you wish and to print out the stickers corresponding to the parameters programmed.

### ► Environment and standards

EMC IMMUNITY	
(standard of reference: IEC 60688, IEC 61326-1, IEC 61000-6-5)	
Shock voltage as per IEC 61000-4-5	2 kV in differential mode 4 kV in common mode
Oscillating wave as per IEC 61000-4-12	1 kV in differential mode 2.5 kV in common mode
Fast electrical transients in bursts as per IEC 61000-4-4	2 kV on power supply 2 kV on inputs/outputs
Electrostatic discharge as per IEC 61000-4-2	8 kV in the air 6 kV in contact
EM radiated field as per IEC 61000-4-3	10 V/m (80 MHz to 3 GHz)
Voltage dips as per IEC 61000-4-11	30% reduction during 20 ms 60% reduction during 1 s
Voltage interruptions as per IEC 61000-4-11	100% reduction during 100 ms 100% reduction during 100 ms

EMC emissions	
Radiated and conducted	As per CISPR11
Climatic specifications (IEC 60068 2-1/2-2/2-30)	
Operating temperature	-10°C to +55°C
Storage temperature	-40°C to +70°C
Relative humidity	≤ 95% to 55°C
Safety specifications (IEC 61010-1)	
Installation category	3
Pollution level	2
Fire resistance	UL94, severity V0
Mechanical specifications (IEC 60068 2-6/2-27/2-29/2-32/2-63)	
Protection rating	IP 20
Mechanical shocks	IEC 60068-2-27
Vibrations	IEC 60068-2-6
Drop test with packaging	NF 0042-1

### ► Mounting accessories

Model	Reference
Plate mounting for T1xy	ACCT 1007
Plate mounting for T3xy	ACCT 1006

### ► Casing

Weight	320 g (T1xy) / 700 g (T3xy)
Mounting	DIN rail 43700 or plate mounting
Connection	Terminals with mobile stirrup clamp with screw for 4 single-wire 6 mm <sup>2</sup> conductors or 2 multi-wire 4 mm <sup>2</sup> conductors

### ► Hardware identification

The TRIAD 2 T1xy and T3xy are fully configurable with the TRIADJUST 2 software which allows users to modify the characteristics of their products right up to the last minute.

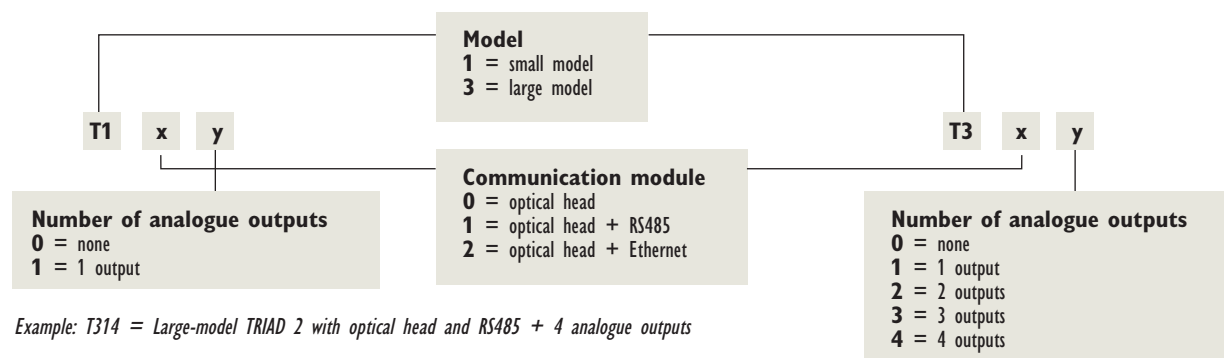

Example: T314 = Large-model TRIAD 2 with optical head and RS485 + 4 analogue outputs





# TRIAD 2 Range

Programmable digital transducers  
 Measurement and instrumentation

Network	Function	T1xy model	T3xy model	
Single-phase	V	•	•	
	I	•	•	
	F	•	•	
	P	•	•	
	Q	•	•	
	S	•	•	
	FP	•	•	
	Tan $\phi$	•	•	
	Cos $\phi$	•	•	
	$\phi$	•	•	
Balanced 3-phase, 3 wires	U12, U23, U31	•	•	
	I1, I2, I3	•	•	
	F	•	•	
	Pt	•	•	
	Qt	•	•	
	St	•	•	
	FPt	•	•	
	Tan $\phi$	•	•	
	Cos $\phi$ t	•	•	
	$\phi$ t	•	•	
	I1, I2, I3 signed	•	•	
	Balanced 3-phase, 4 wires	V1, V2, V3	•	•
		U12, U23, U31	•	•
I1, I2, I3		•	•	
F		•	•	
P1, P2, P3, Pt		•	•	
Q1, Q2, Q3, Qt		•	•	
S1, S2, S3, St		•	•	
FP1, FP2, FP3, FPt		•	•	
Tan $\phi$		•	•	
Cos ( $\phi$ 1, $\phi$ 2, $\phi$ 3, $\phi$ t)		•	•	
$\phi$ 1, $\phi$ 2, $\phi$ 3, $\phi$ t		•	•	
I1, I2, I3 signed		•	•	
Unbalanced 3-phase, 3/4 wires		V1, V2, V3		•
	U12, U23, U31		•	
	I1, I2, I3		•	
	F		•	
	P1, P2, P3, Pt		•	
	Q1, Q2, Q3, Qt		•	
	S1, S2, S3, St		•	
	FP1, FP2, FP3, FPt		•	
	Tan $\phi$		•	
	Cos ( $\phi$ 1, $\phi$ 2, $\phi$ 3, $\phi$ t)		•	
	$\phi$ 1, $\phi$ 2, $\phi$ 3, $\phi$ t		•	
	$\phi$ (U12/U23, U23/U31, U31/U12)		•	
	$\phi$ (V1/V2, V2/V3, V3/V1)		•	
	I1, I2, I3 signed		•	
Split-phase	V1, V2		•	
	U12		•	
	I1, I2		•	
	F		•	
	P1, P2, Pt		•	
	Q1, Q2, Qt		•	
	S1, S2, St		•	
	FP1, FP2, FPt		•	
	Tan $\phi$		•	
	Cos ( $\phi$ 1, $\phi$ 2, $\phi$ t)		•	
	$\phi$ 1, $\phi$ 2, $\phi$ t		•	
	$\phi$ (V1/V2)		•	
	I1 signed, I2 signed		•	

# TRIAD 2

## Programmable model

### ► Electrical specifications

Voltage input		
Rated value	T1: from 57.7 Vac to 276 Vac max. T3: from 57.7 Vac to 480 Vac max.	
Frequency	50 Hz: 42.5...57.5 Hz 60 Hz: 51...69 Hz	
Max. measured voltage on primary	1,000 kV (ph-ph)	
Acceptable overloads	T1: 300 Vac permanent - 460 Vac / 10s T3: 520 Vac permanent - 800 Vac / 10s	
Consumption	< 0.2 A	
Input impedance	400 kΩ	
Current inputs		
Rated value	0 to 10 A max.	
Max. measured current on primary	40,000 A	
Acceptable overload	50 I <sub>n</sub> / 1 s	
Consumption	< 0.15 VA	
Auxiliary power supply		
High level	80 / 265 Vac (50/60 Hz) – 110 to 375 Vdc	
Low level	19 / 58 Vdc	
Consumption	<b>High level</b>	<b>Low level</b>
	T1: 8.5 VA max. T3: 20 VA max.	T1: 5 W max. T3: 10 W max.
Analogue outputs		
Rated values	<b>Current</b>	<b>Voltage</b>
	± 1 mA, ± 5 mA, ± 20 mA	± 1 V, ± 10 V
Acceptable resistive load	15 V / I <sub>o</sub> <sup>(1)</sup>	≤ 1 kΩ
Acceptable capacitive load	0.1 μF	0.1 μF
Overrun	1.2 I <sub>o</sub> <sup>(1)</sup>	1.2 U <sub>o</sub> <sup>(1)</sup>
Peak-peak residual wave	± 0.2% of I <sub>o</sub> <sup>(1)</sup>	± 0.2% of U <sub>o</sub> <sup>(1)</sup>
Programmable response time	50 ms – 100 ms – 200 ms – 500 ms – 1 s	
Transfer curve	Linear, 2 slopes or quadratic	

<sup>(1)</sup> I<sub>o</sub> = output current, U<sub>o</sub> = output voltage

### ► Communication

	Optical head	Ethernet	RS485
Connection	USB (PC) Optical (product)	RJ45	2 wires Half-duplex
Protocol	MODBUS RTU mode	MODBUS / TCP RTU mode	MODBUS / JBUS RTU mode
Speed	38,400 baud	10 base T	2,400 to 115,200 baud
Parity	-	-	Even, odd or none
JBus addresses	-	-	1 to 247
Transmission length	2 m	100 m	1.2 km as EIA 485

### ► Metrological specifications

Measurements	Accuracy class over measurement range (as per IEC 60688)				
	RT = 50 ms	RT = 100 ms	RT = 200 ms	RT = 500 ms	RT = 1 s
V, U, I, F, P, Q, S, FP, Tanφ, Cosφ, φ, φU, φV	± 1%	± 0.5%	± 0.2%	± 0.15%	± 0.1%

\* RT: Response time for F = 50 Hz

\*\* Phase angle between voltages



# TRIAD 2 Range

## ► Electrical connections Single-phase network

Programmable digital transducers

► Measurement and instrumentation

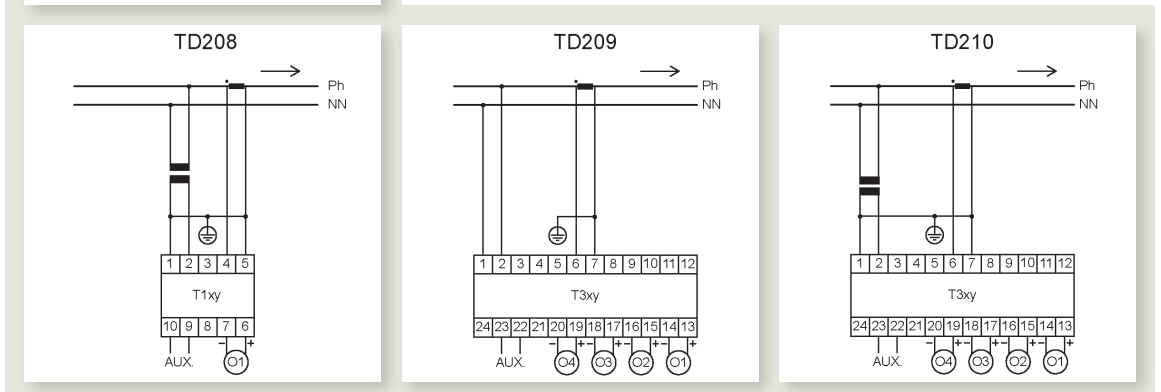
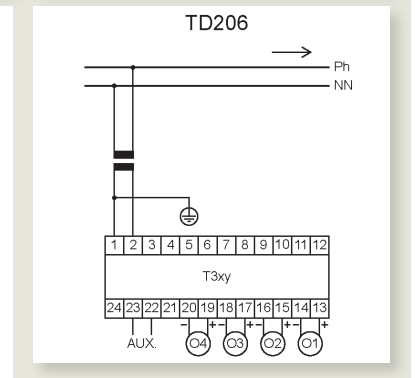
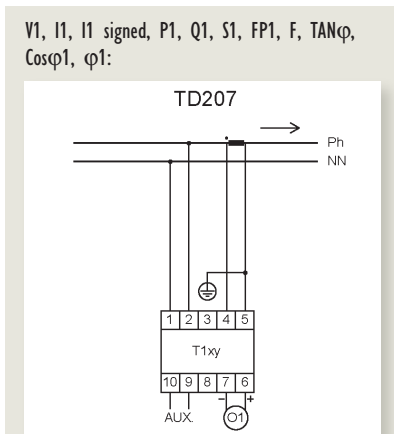
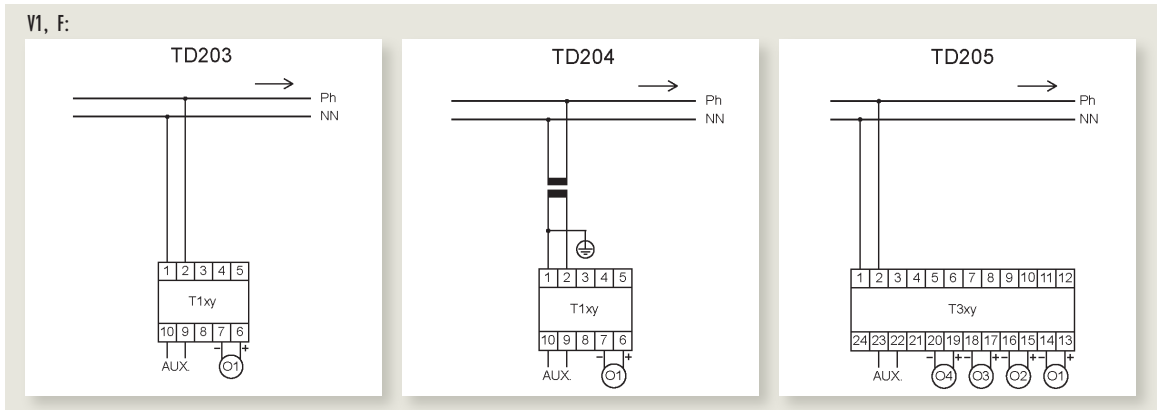
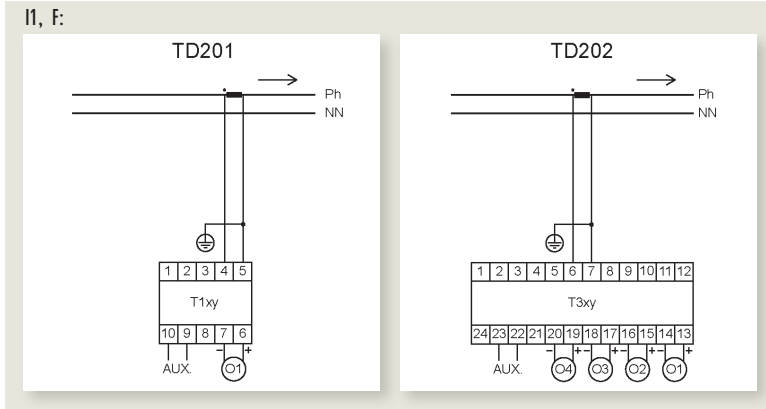

## Balanced 3-phase, 3-wire network

U12, U23, U31, F:

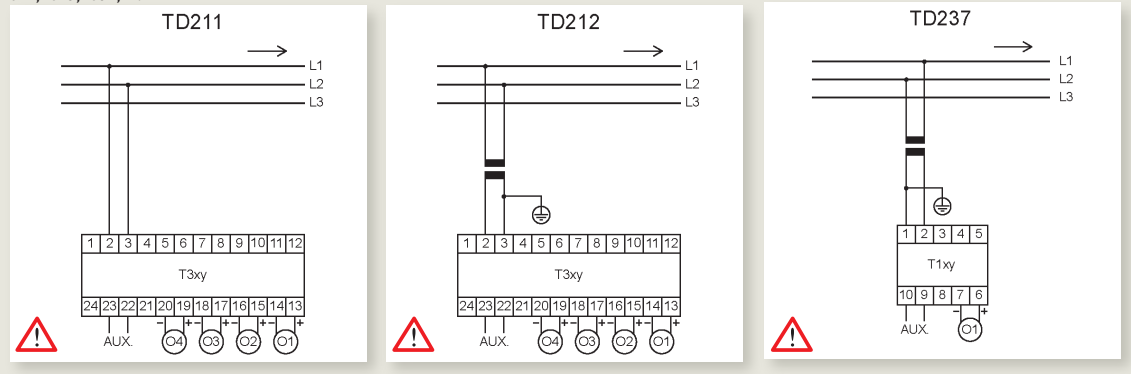

I1, I2, I3, F:

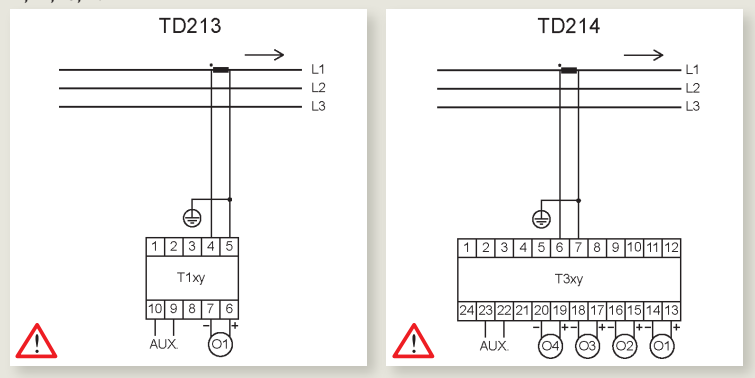

U12, U23, U31, I1, I2, I3, signed (I1, I2, I3), Pt, St, Qt, FPt, F, TANφ, Cosφpt, φpt:

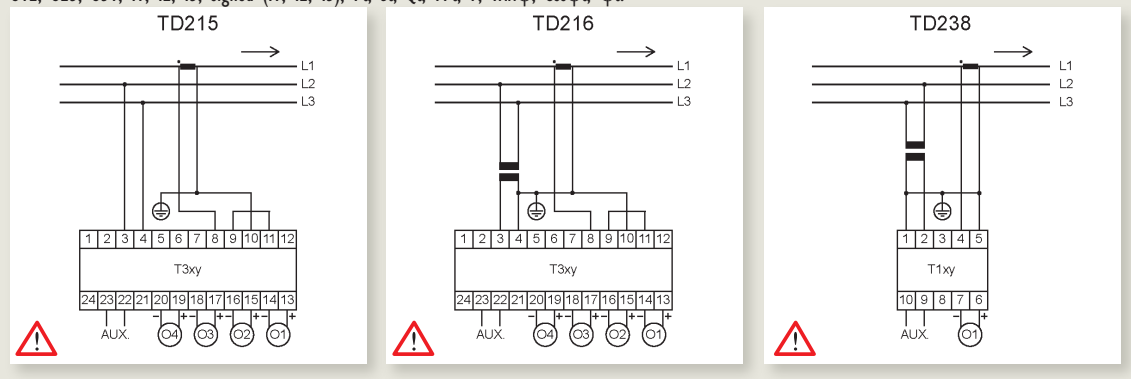

Phase rotation authorized



# TRIAD 2 Range

Balanced 3-phase, 4-wire network

Programmable digital transducers  
Measurement and instrumentation

V1, V2, V3, U12, U23, U31 F:

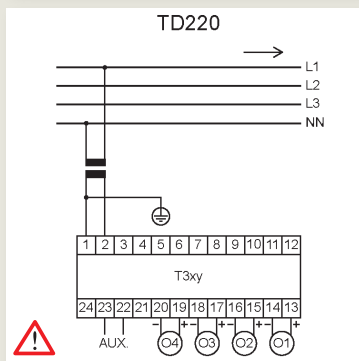
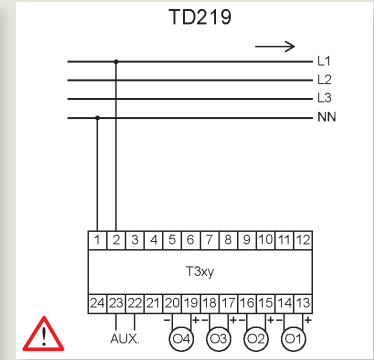
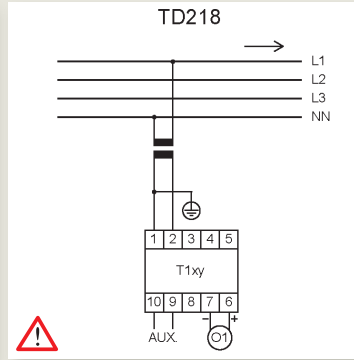
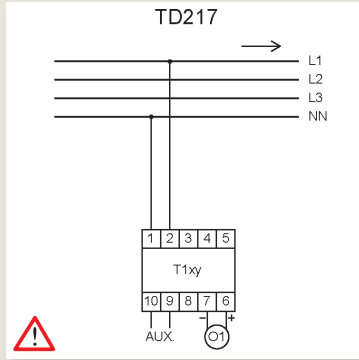

I1, I2, I3, F:

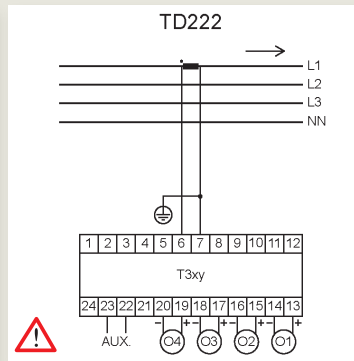
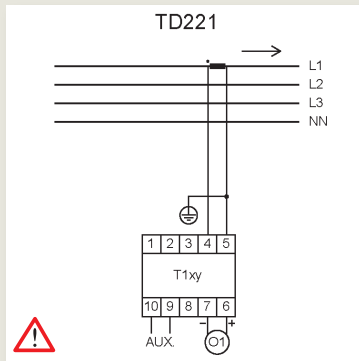

Phase rotation authorized

### Balanced 3-phase, 4-wire network (continued)

V1, V2, V3, U12, U23, U31, I1, I2, I3, signed (I1, I2, I3), P1, P2, P3, Pt, S1, S2, S3, St, Q1, Q2, Q3, Qt, FP1, FP2, FP3, FPt, F, TANφ, Cosφ1, Cosφ2, Cosφ3, Cosφt, φ1, φ2, φ3, φt:

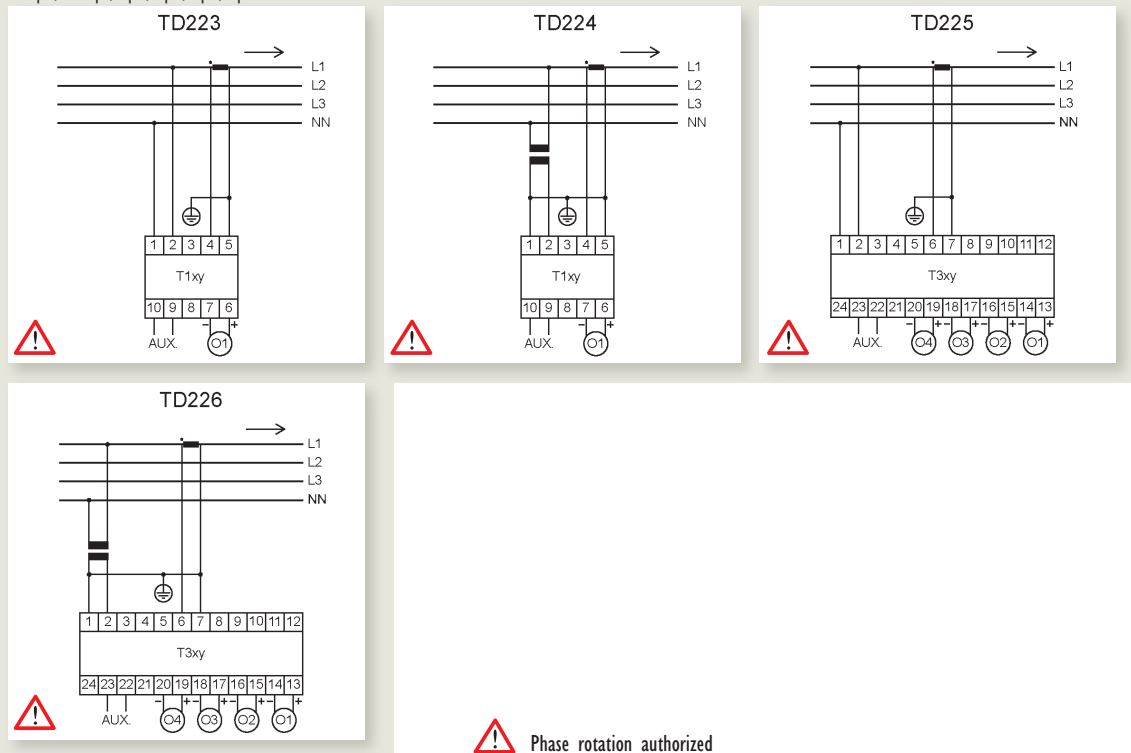

### Unbalanced 3-phase, 3-wire network

U12, U23, U31, F, Angle (U12/U23, U23/U31, U31/U12):

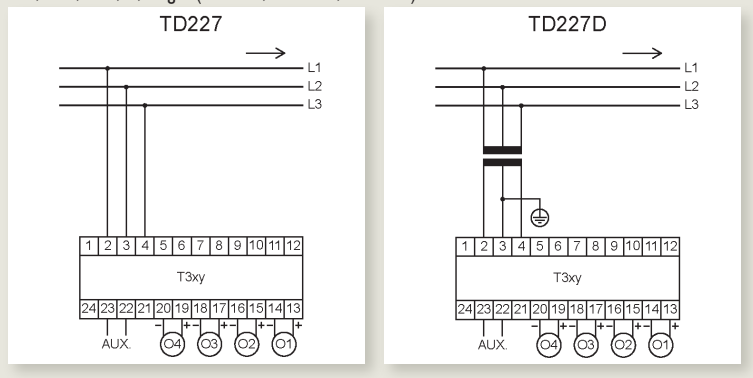

V1, V2, V3, U12, U23, U31, F,  
Angle (V1/V2, V2/V3, V3/V1),  
Angle (U12/U23, U23/U31, U31/U12):

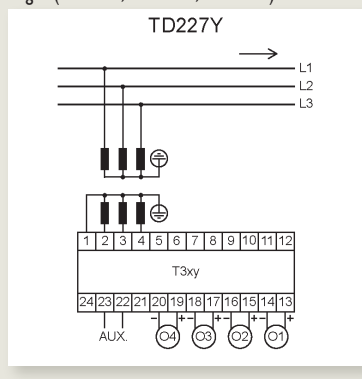





# TRIAD 2 Range

Unbalanced 3-phase, 3-wire network (continued)

Programmable digital transducers  
 Measurement and instrumentation

I1, I2, I3, F:

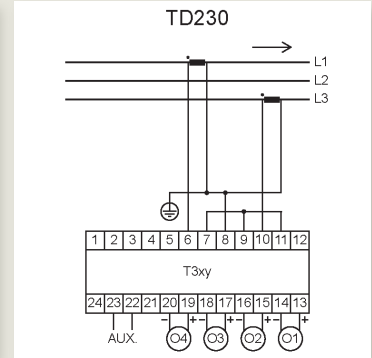
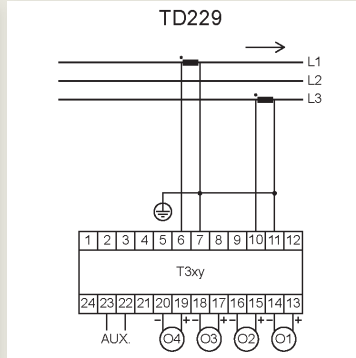
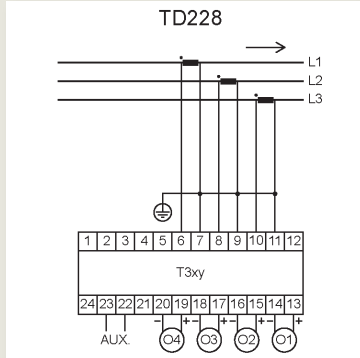

U12, U23, U31, I1, I2, I3, signed (I1, I2, I3), Pt, St, Qt, FPt, F, TANφ, Cosφpt, φpt, Angle (U12/U23, U23/U31, U31/U12):

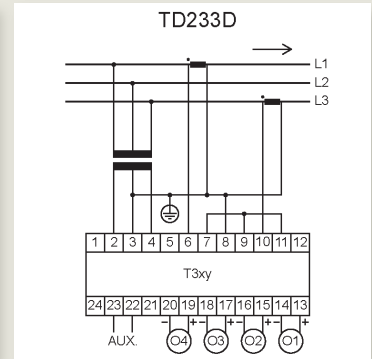
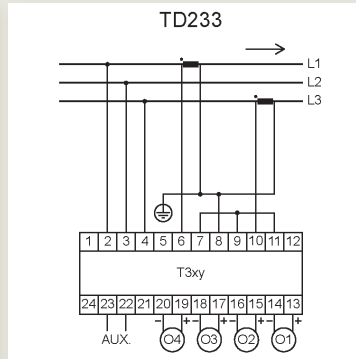
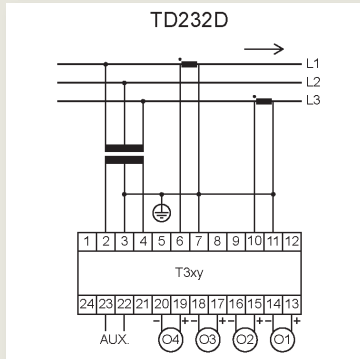
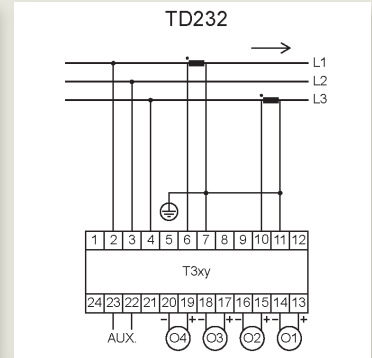
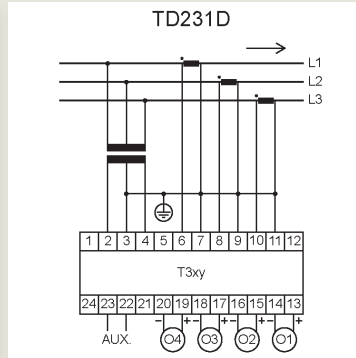
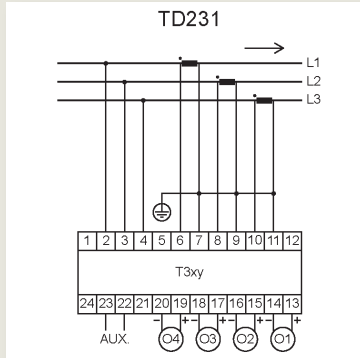

V1, V2, V3, U12, U23, U31, I1, I2, I3, signed (I1, I2, I3), P1, P2, P3, Pt, S1, S2, S3, St, Q1, Q2, Q3, Qt, FP1, FP2, FP3, FPt, F, TANφ, Cosφ1, Cosφ2, Cosφ3, Cosφpt, φ1, φ2, φ3, φpt, Angle (V1/V2, V2/V3, V3/V1), Angle (U12/U23, U23/U31, U31/U12):

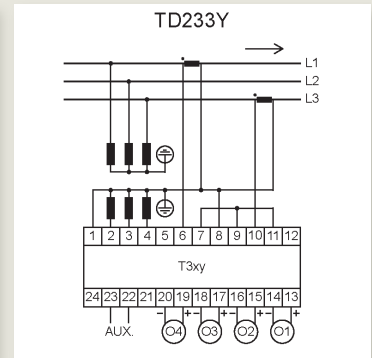
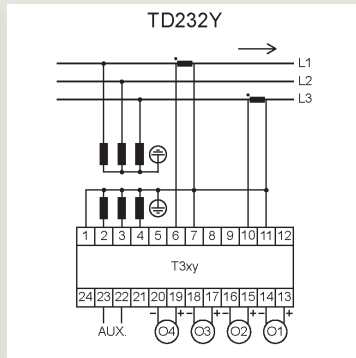
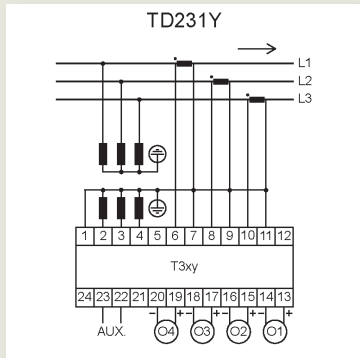

### Unbalanced 3-phase, 4-wire network

I1, I2, I3, F:

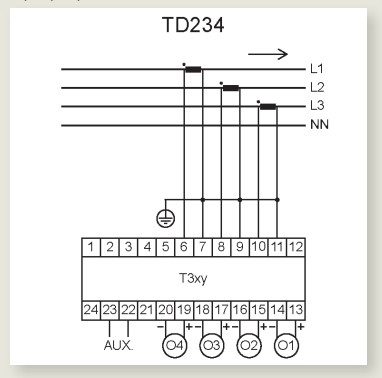

V1, V2, V3, U12, U23, U31, F, Angle (V1/V2, V2/V3, V3/V1), Angle (U12/U23, U23/U31, U31/U12):

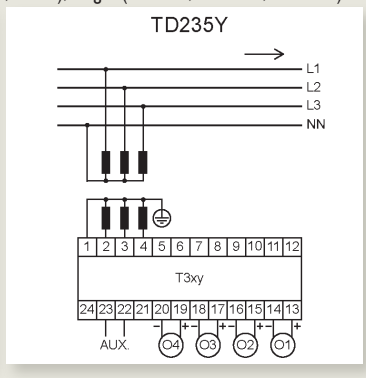
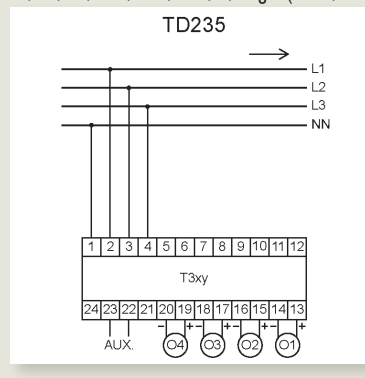

V1, V2, V3, U12, U23, U31, I1, I2, I3, signed (I1, I2, I3), P1, P2, P3, Pt, S1, S2, S3, St, Q1, Q2, Q3, Qt, FP1, FP2, FP3, FPt, F, TANφ, Cosφ1, Cosφ2, Cosφ3, Cosφt, φ1, φ2, φ3, φt  
Angle (V1/V2, V2/V3, V3/V1), Angle (U12/U23, U23/U31, U31/U12):

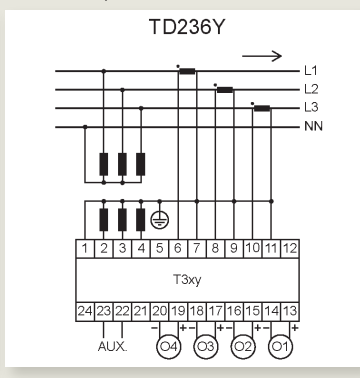
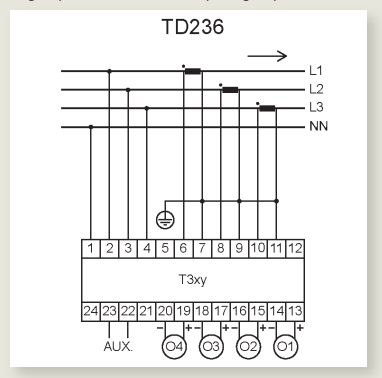



# TRIAD 2 Range

Split-phase

Programmable digital transducers

▲ Measurement and instrumentation

I1, I2, F:

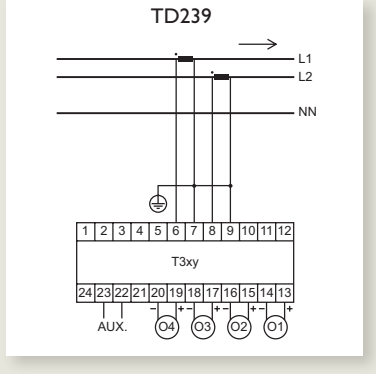

V1, V2, U12, F, Angle (V1/V2) rad, Angle (V1/V2) deg:

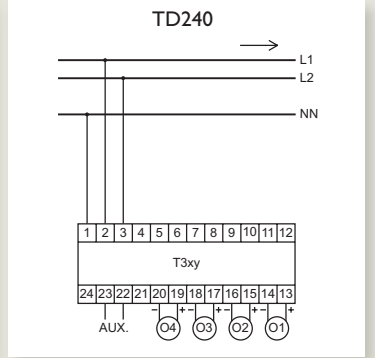
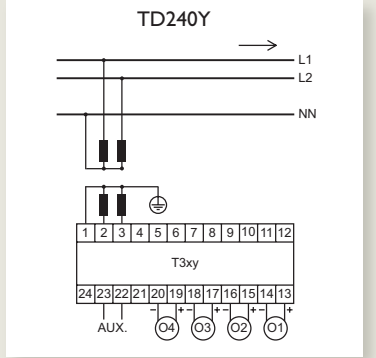

V1, V2, U12, I1, I2, P1, P2, Pt, Q1, Q2, Qt, S1, S2, St, FP1, FP2, FPt, F, tan  $\varphi$ , Angle (V1/V2) rad, Angle (V1/V2) deg, cos  $\varphi_1$ , cos  $\varphi_2$ , cos  $\varphi_t$ ,  $\varphi_1$  Fonda rad,  $\varphi_2$  Fonda rad,  $\varphi_t$  Fonda rad,  $\varphi_1$  Fonda. deg,  $\varphi_2$  Fonda. deg,  $\varphi_t$  Fonda. deg, Angle V1/V2 Fonda deg, I1 (signed), I2 (signed):

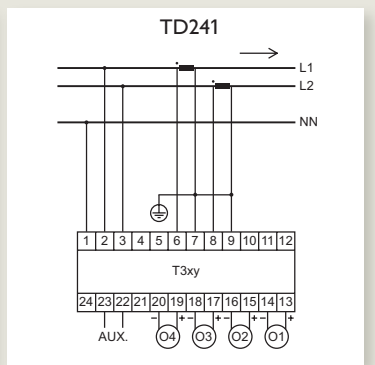
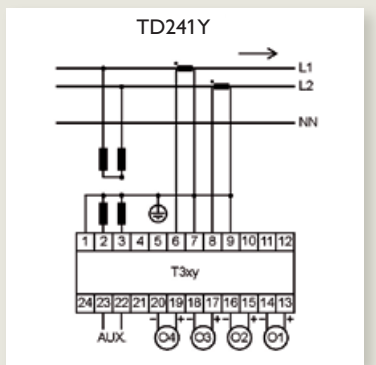

► Dimensions (in mm)

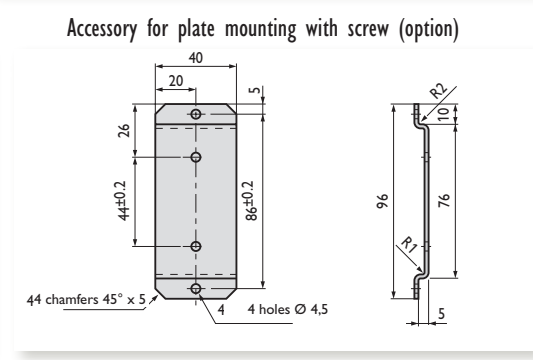
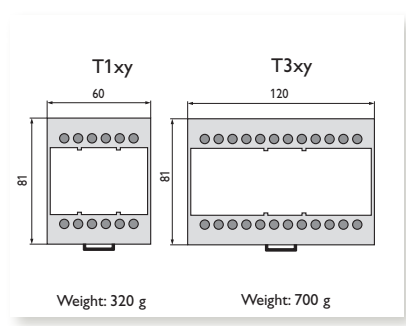
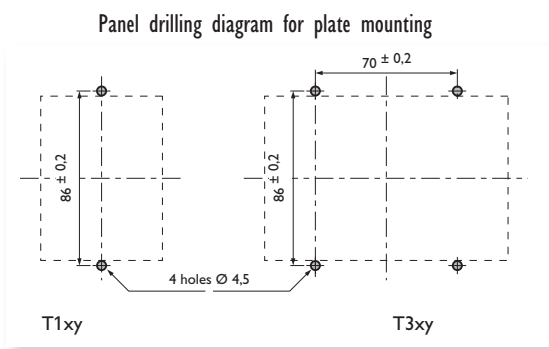
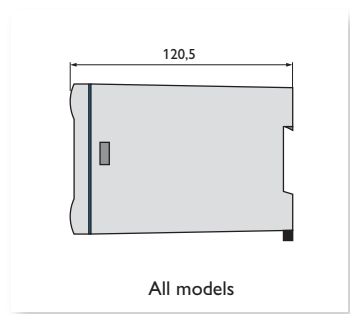

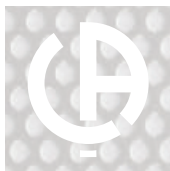

# TRIAD 2 Range

TRIAD 2 programmable via TRIADJUST 2

Programmable digital transducers

Measurement and instrumentation

TO ORDER

## ► T1 — SMALL MODEL (60 x 81 x 120.5 mm)

Link	Output	Supply	Without tropicalization	With tropicalization
			Number of output 1	Number of output 1
Optical	± 20 mA	80-265 V AC/DC	P01380001	P01380002
		19-58 V DC	P01380003	P01380004
	± 10 V	80-265 V AC/DC	P01380005	P01380006
		19-58 V DC	P01380007	P01380008

## ► T3 — LARGE MODEL (120 x 81 x 120.5 mm)

Link	Output	Supply	Without tropicalization				With tropicalization			
			Number of output(s)				Number of output(s)			
			1	2	3	4	1	2	3	4
Optical	± 20 mA	80-265 V AC/DC	P01380101	P01380103	P01380105	P01380107	P01380102	P01380104	P01380106	P01380108
		19-58 V DC	P01380109	P01380111	P01380113	P01380115	P01380110	P01380112	P01380114	P01380116
	± 10 V	80-265 V AC/DC	P01380117	P01380119	P01380121	P01380123	P01380118	P01380120	P01380122	P01380124
		19-58 V DC	P01380125	P01380127	P01380129	P01380131	P01380126	P01380128	P01380130	P01380132

## ► TRIAD 2 factory-programmable

### 1 Model - Frequency

T1: small model — 1 analogue output  
T3: large model — 1 to 4 analogue output(s)

0: 50 Hz  
1: 60 Hz

### 2 Network

0: Single-phase  
1: Balanced 3-phase, 3 wires  
2: Balanced 3-phase, 4 wires  
3: Unbalanced 3-phase, 3 wires  
4: Unbalanced 3-phase, 4 wires  
5: Split-phase

### 3 Communication - Connection

0: Without  
1: RS485  
2: Ethernet  
Indicate the diagram number. E.g. TD204

### 4 Supply

0: 80-265 V AC/DC  
1: 19-58 V DC

### 5 Tropicalization

0: Without  
1: With

### 6 Inputs

Indicate direct voltage to be measured or the VT ratio  
Indicate direct current to be measured or the CT ratio

### 7 Number of analogue outputs

0: Without (Choice of a minimum communication)  
1: 1 output  
2: 2 outputs (T3 model only)  
3: 3 outputs (T3 model only)  
4: 4 outputs (T3 model only)

### 8 Analogue outputs

Indicate for each output:

a- Quantity to be measured  
b- Transfer curve  
c- Input signal: Min — Breaking point - Max  
d- Input unity  
e- Output signal: Min — Breaking point - Max

### 9 Analogue output calibres

0: -20 mA to +20 mA  
1: -5 mA to +5 mA  
2: -1 mA to +1 mA  
3: -10 V to +10 V  
4: -1 V to +1 V

**To simplify the procedure when ordering you can send us the form on page 237.**

# Factory-programmed TRIAD 2: order form

### 1 - Model / Hz

T1 or  T3  
 50 Hz or  60 Hz

### 2 - Network

Single-phase  
 3-wire balanced three-phase  
 4-wire balanced three-phase  
 3-wire unbalanced three-phase  
 4-wire unbalanced three-phase  
 Split-phase

### 3 - Communication / Connection

Ethernet or  RS485  
 Connection diagram: TD     cf: p162 to p168

### 4 - Power supply

80 to 265 Vac (50/60 Hz) / 110 to 375 Vdc or  19 to 58 Vdc

### 5 - Tropicalization

With  Without

### 6 - Inputs

**Current**

With current transformer or Direct  
 Primary Secondary  
 /  A  A

**Voltage**

With voltage transformer or Direct  
 Primary Secondary  
 /  V  V

Phase-phase  Phase-neutral ( $\sqrt{3}$ )

### Available quantities

V1 V2 V3 U12 U23 U31 I1 I2 I3 F P1 P2 P3 Pt Q1 Q2 Q3 Qt S1 S2 S3 St  
 FP1 FP2 FP3 FPt TANφ COSφ1 COSφ2 COSφ3 COSφt φ1 φ2 φ3 φt  
 φU12/23 φU23/31 φU31/12 V1/2 V2/3 V3/1 I1 I2 I3 signed

### 7 - Number of analogue outputs

0: Without (Choice of a minimum communication)  
 1: 1 output  
 2: 2 outputs (T3 model only)  
 3: 3 outputs (T3 model only)  
 4: 4 outputs (T3 model only)

### 8 / 9 - Analogue outputs calibres

**Output 1** Quantity and measurement range (x)

Indicate quantity to be measured

Min  breaking point  Max  Unit <sup>(1)</sup>

**Transfer curve**

Linear  
 2 slopes  
 Quadratic

**Output signal (y)**

Min  Breaking point  Max   mA  V

**Accuracy class**

50 Hz	60 Hz
<input type="checkbox"/> 0.1%: 1 s	0.8 s
<input type="checkbox"/> 0.15%: 0.5 s	0.4 s
<input type="checkbox"/> 0.2%: 0.2 s	0.16 s
<input type="checkbox"/> 0.3%: 100 ms	80 ms
<input type="checkbox"/> 1%: 50 ms	40 ms

**Output 2** Quantity and measurement range (x)

Indicate quantity to be measured

Min  breaking point  Max  Unit <sup>(1)</sup>

**Transfer curve**

Linear  
 2 slopes  
 Quadratic

**Output signal (y)**

Min  Breaking point  Max   mA  V

**Accuracy class**

50 Hz	60 Hz
<input type="checkbox"/> 0.1%: 1 s	0.8 s
<input type="checkbox"/> 0.15%: 0.5 s	0.4 s
<input type="checkbox"/> 0.2%: 0.2 s	0.16 s
<input type="checkbox"/> 0.3%: 100 ms	80 ms
<input type="checkbox"/> 1%: 50 ms	40 ms

**Output 3** Quantity and measurement range (x)

Indicate quantity to be measured

Min  breaking point  Max  Unit <sup>(1)</sup>

**Transfer curve**

Linear  
 2 slopes  
 Quadratic

**Output signal (y)**

Min  Breaking point  Max   mA  V

**Accuracy class**

50 Hz	60 Hz
<input type="checkbox"/> 0.1%: 1 s	0.8 s
<input type="checkbox"/> 0.15%: 0.5 s	0.4 s
<input type="checkbox"/> 0.2%: 0.2 s	0.16 s
<input type="checkbox"/> 0.3%: 100 ms	80 ms
<input type="checkbox"/> 1%: 50 ms	40 ms

**Output 4** Quantity and measurement range (x)

Indicate quantity to be measured

Min  breaking point  Max  Unit <sup>(1)</sup>

**Transfer curve**

Linear  
 2 slopes  
 Quadratic

**Output signal (y)**

Min  Breaking point  Max   mA  V

**Accuracy class**

50 Hz	60 Hz
<input type="checkbox"/> 0.1%: 1 s	0.8 s
<input type="checkbox"/> 0.15%: 0.5 s	0.4 s
<input type="checkbox"/> 0.2%: 0.2 s	0.16 s
<input type="checkbox"/> 0.3%: 100 ms	80 ms
<input type="checkbox"/> 1%: 50 ms	40 ms

<sup>(1)</sup> Please indicate the unit of the measurement range, e.g. V, kW or MW





# TRIADJUST 2 software

Designed for quick configuration and display of all the parameters of your TRIAD 2 transducers

Programmable digital transducers

Measurement and instrumentation

**PRODUCT ADVANTAGES**

- +** CONFIGURATION via OPTICAL HEAD, ETHERNET or RS485
- +** ACCESS to ALL the TRIAD 2 PARAMETERS
- +** DIAGNOSIS of the INSTALLATION
- +** LABEL PRINTING on ALL TYPES OF LASER PRINTERS

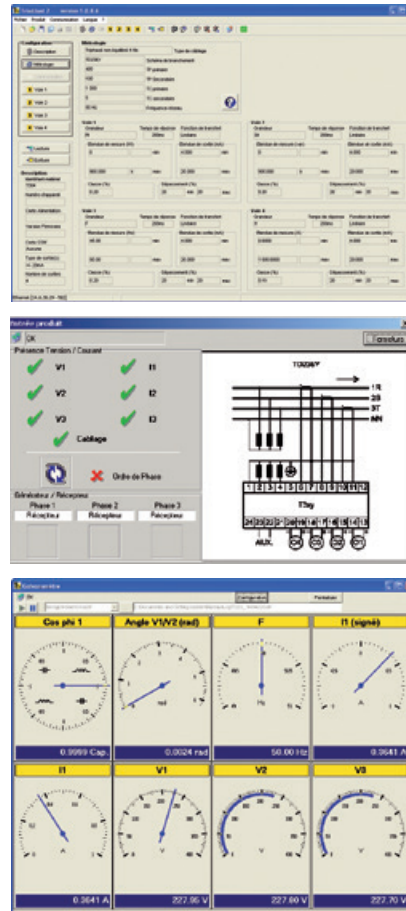

## Configuration

- Inputs / Outputs
- Communication
- Connection diagram
- Accuracy class
- Set-up function protected by password

## Diagnosis

- Voltage inputs
- Current inputs
- Cabling
- Phase order
- Analogue outputs
- Fresnel

## Display

- Instantaneous quantities (in digital or analogue form)

## Recording

- In real time in exported file

## ► Description

The **TRIADJUST 2** software allows quick, unlimited programming of all your TRIAD 2's parameters.

Using a PC and the optical lead supplied in each kit, connect your product's auxiliary power supply to dialogue with total security. Depending on your TRIAD 2's configuration, remote communication is possible via RS485 or Ethernet.

In the Windows™ environment, initialize or simply modify the quantities measured, the measurement ranges and the analogue outputs on the transducers installed.

**TRIADJUST 2** also offers other functions such as **DIAGNOSIS** of your network, instantaneous **DISPLAY** of the electrical quantities and **REAL-TIME RECORDING** of the measurements in an exported file.

You can also print labels indicating the configurations and connections of your products.

## ► Minimum configuration

**Platform:** PC

**Operating system:** Windows 2000 or XP

**Processor:** Pentium-compatible

**RAM:** 128 MB

**Hard disk:** 40 GB

**Drive:** CD-ROM

**Communication port:**

Local: USB 1.1 minimum

Remote: RS485 and/or Ethernet

## KIT TRIADJUST 2



The **TRIADJUST 2 configuration kit** comprises:

- The TRIADJUST 2 software
- An optical / USB lead
- 30 sheets of blank labels
- A 230 x 185 x 45 mm carrying case

## TRIADJUST 2 "PREMIER"

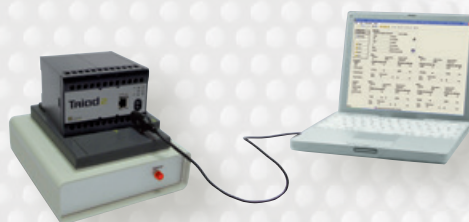

This module is a **complete tool** designed for distributors or any user needing to program a large number of transducers

The TRIADJUST 2 "PREMIER" configuration workstation comprises:

- The TRIADJUST 2 software
- An optical / USB lead
- A benchtop power-supply base
- 210 sheets of blank labels
- A 500 x 400 x 270 mm carrying case

## Labels common to both kits

A sheet contains two labels, one for the configuration of the inputs/outputs and the other for the programmed connection diagram. The labels can be printed on all types of laser printers.

T314	
<b>Inputs:</b>	<b>50-60 Hz</b>
10 000 V/√3	100 V/√3
1 000 A	5 A
<b>AO 1: V1</b>	0,20   200 ms   750 Ω
	0V...5 773,5V
	4 mA...20 mA
<b>AO 2: I1</b>	0,20   200 ms   750 Ω
	0A...1 000A
	4 mA...20 mA
<b>AO 3: Pt</b>	0,20   200 ms   750 Ω
	0W...17,32 MW
	4 mA...20 mA
<b>AO 4: F1</b>	0,20   200 ms   750 Ω
	45 Hz...55 Hz
	4 mA...20 mA
Made in France	
Reference client / Own reference customer	

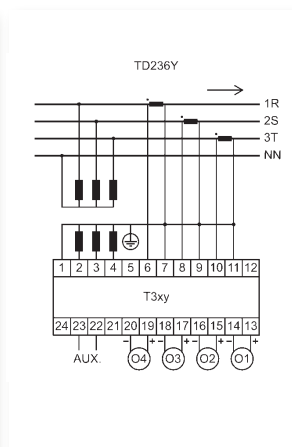

### T O O R D E R

Model	Reference
TRIADJUST 2 kit	P01380410
TRIADJUST 2 "PREMIER" workstation	P01380420
Accessories	
Set of 30 sheets of blank labels	P01380400
Optical/USB lead	P01330403

**THE TRIADJUST 2 SOFTWARE ALONE  
CAN BE DOWNLOADED FREE OF CHARGE**  
from the support area of the [www.enerdis.com](http://www.enerdis.com) website

## ► Associated product

TRIAD 2 programmable  
with TRIADJUST 2

► page 159



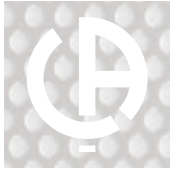

# MICAR 2 Range

Multi-function digital transducers  
2 or 4 analogue outputs / Class 0.2

Multi-function digital transducers  
Measurement and instrumentation

## PRODUCT ADVANTAGES

- + CLASS 0.2**  
Insulation 4 kV
- + Up to 4 CONFIGURABLE ANALOGUE OUTPUTS**
- + Option of 2 or 4 ON-OFF outputs**
- + COMMUNICATION**  
and programming via optical head or remotely via Ethernet network or RS485 output
- + ELECTRICAL NETWORK SUPERVISION**  
and display of the energy values, harmonics and THD using the **E.view+** software



Local communication via optical head



Remote communication via Ethernet network

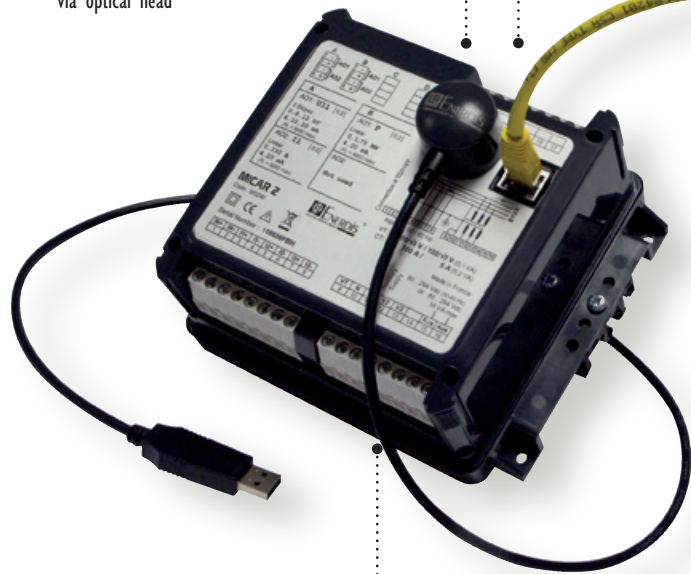

Simplified connection with screw-on terminal strip

## ► General specifications

### Quantities measured:

Choice of 1, 2, 3 or 4 among 32 electrical quantities

**Configuration:** in factory or by user with the **E.view+** software

**Accuracy:** Class 0.2

**Current inputs:** 1 A and 5 A

**Voltage inputs:** 100 to 400 V (ph-ph) or  $100 / \sqrt{3}$  to  $400 / \sqrt{3}$  V (ph-N)

**Transfer curves:** linear, 2 slopes, quadratic

**Output signal:** configurable between - 20 mA and + 20 mA

**Response time:** 350 ms

**Operating frequency:** 50 or 60 Hz

**Auxiliary source with wide dynamic range:** 80 to 264V ac/dc or 19 to 57Vdc

**Compliance with CE directive**

## ► Electrical specifications

<b>Voltage inputs</b>	
Rated value	$100\text{ V} \leq U_n \leq 400\text{ V (ph-ph)}$ $57.7 \leq V_n \leq 230\text{ V (ph-N)}$
Frequency	50/60 Hz
Max. phase-to-phase voltage measured	650 kV (ph-ph)
Acceptable overvoltage	800 V for 24 hours. 552 V permanent
Consumption	< 0.2 VA
Input impedance	2 M $\Omega$
<b>Current inputs</b>	
Rated value (I <sub>n</sub> )	1 A and 5 A
Max. current measured on primary	25,000 A
Acceptable overload	6.5 A permanent, 250 A for 1 second, 5 times every 5 minutes
Consumption	< 0.15 VA
<b>Auxiliary power supply</b>	
High level (standard)	80 to 265 Vac / 80 to 264 Vdc (< 15 VA)
Low level (option)	19.2 to 57 Vdc
<b>Pulse outputs or alarm relays</b>	
Type	static relay
Operating voltage	24 to 110 Vdc $\pm$ 20% 24 to 115 Vac -10% +15%
Max. current	100 mA
Compliance with standard	IEC 62053-31
<b>Analogue output</b>	
Scale	Configurable between -20 mA and +20 mA
Acceptable load	500 $\Omega$ , 10 V/I output
Typical response time	350 ms
<b>RS 485 output</b>	
Connection	2 wires, half-duplex
Protocol	ModBus / JBus RTU mode
Speed (configurable)	2,400 – 4,800 - 9,600 – 19,200 – 38,400
Parity	even, odd or none
JBus addresses	1 to 247
<b>Ethernet output</b>	
Type	RJ45 – 8-pin
Protocol	ModBus/TCP
Speed (configurable)	Compatible with 10baseT



# MICAR 2 Range

Multi-function digital transducers

► Measurement and instrumentation

## ► Metrological specifications

### Analogue outputs

Type	Conditions	Accuracy class
-20...+20 mA	Measurement of I, U, V, P, S, FP and F	Class 0.2 according to IEC 60688
	Measurement of Q	Class 0.5 according to IEC 60688

### Digital communication output

Standard quantity	Conditions	Accuracy class
V	V between 10% and 120% of $V_n^{(1)}$	$\pm 0.2\%$ of V $\pm 0.02\%$ of $V_n$
U	U between 10% and 120% of $U_n^{(2)}$	$\pm 0.2\%$ of U $\pm 0.02\%$ of $U_n$
I	I between 5% and 130% of $I_n$	$\pm 0.2\%$ of I $\pm 0.02\%$ of $I_n$
F	F between 42.5 Hz and 69 Hz	$\pm 0.1$ Hz
P	FP between 0.5 inductive and 0.8 capacitive • U between 99% and 101% of $U_n^{(2)}$ • I between 5% and 130% of $I_n$	$\pm 0.2\%$ of P $\pm 0.02\%$ of $P_n$
Q	FP between 0.5 inductive and -0.5 capacitive • U between 99% and 101% of $U_n^{(2)}$ • I between 5% and 130% of $I_n$	$\pm 0.5\%$ of Q $\pm 0.05\%$ of $Q_n$
S	U between 99% and 101% of $U_n^{(2)}$ • I between 5% and 130% of $I_n$	$\pm 0.2\%$ of S $\pm 0.02\%$ of $S_n$
FP, Cos $\phi$	FP between 0.5 inductive and 0.5 capacitive * U between 99% and 101% of $U_n^{(2)}$ * I between 5% and 130% of $I_n$	$\pm 0.02$ counts

<sup>(1)</sup>  $V_n$  from 57.7 V to 230 V    <sup>(2)</sup>  $U_n$  from 100 V to 400 V

Special quantity	Accuracy class
Active energy	Class 0.5s according to IEC 62053-22
Reactive energy	Class 2 according to IEC 62053-23
Apparent energy	$\pm 0.5\%$
THD-I, THD-V and THD-U	$\pm 0.5$ counts
Harmonics order by order on U, V and I	$\pm 0.5$ counts

## ► Dimensions

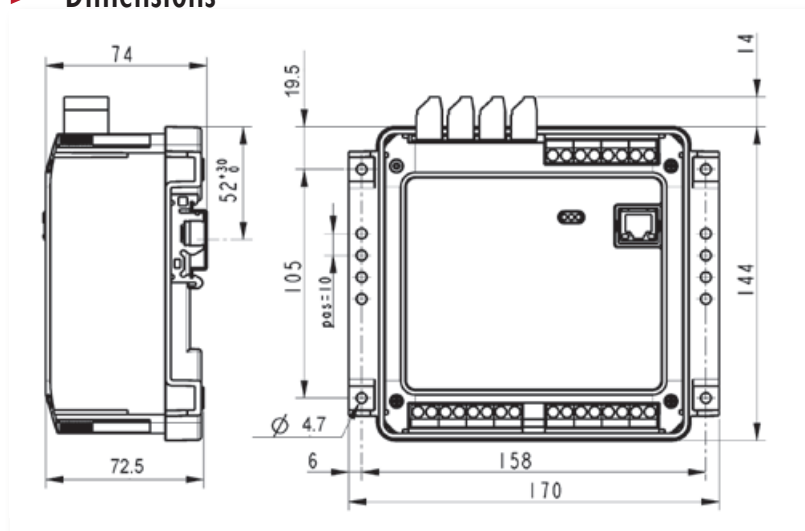

## ► Environmental specifications

Climate specifications	
Operating temperature	-10°C to +55°C
Operating humidity	95% at 40°C
Storage temperature	-25°C to +70°C
Safety specifications	
Degree of pollution	2
Behaviour in fire	UL94, severity V1
Installation category	3
Mechanical specifications	
Protection rating	IP51 on front panel and IP20 on rear panel
Mechanical shocks	IEC 61010-1
Vibrations	IEC 60068-2-6 (method A)
Free fall with packaging	NF H 0042-1
Electromagnetic compatibility	
Generic standard	IEC 61326-1

## ► Mounting accessories

Weight	700 g
Mounting	DIN 43700 rail or platen
Connection	Screw terminals for 6 mm <sup>2</sup> rigid or flexible wires on current measurement inputs and 2.5 mm <sup>2</sup> for the other accesses

## ► Functions

Measurement	On-off output				
	Analogue output	Alarm relay	Pulse output	Communication output	Display with E.view+
V1, V2, V3, Vearth	•	•		•	•
U12, U23, U31	•	•		•	•
I1, I2, I3, In	•	•		•	•
P1, P2, P3	•			•	•
Pt	•	•		•	•
Q1, Q2, Q3	•			•	•
Qt	•	•		•	•
S1, S2, S3	•			•	•
St	•	•		•	•
FP1, FP2, FP3	•			•	•
FPt	•	•		•	•
Cosφ1, Cosφ2, Cosφ3,	•			•	•
Cosφt	•	•		•	•
Frequency	•	•		•	•
Crest factor V1, V2, V3				•	•
Crest factor I1, I2, I3				•	•
Unbalance U				•	•
Harmonics: V1, V2, V3, U12, U23, U31, I1, I2, I3				•	•
THD: V1, V2, U12, U23, U31, I1, I3				•	•
Active energy: receiver, generator			•	•	•
Reactive energy: Qcad1, Qcad2, Qcad3, Qcad4			•	•	•
Apparent energy: receiver, generator			•	•	•





# MICAR 2 Range

Multi-function digital transducers

Measurement and instrumentation

## Electrical connections

### Configurations for single-phase networks

I1, V1, P1, S1, Q1, FP1, Cosφ1, F:

TD301 configuration

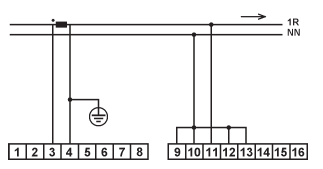

TD302 configuration

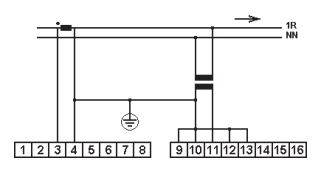

### Balanced 3-phase network with 4 wires

I1, I2, I3, V1, V2, V3, P1, P2, P3, Pt, S1, S2, S3, St, Q1, Q2, Q3, Qt, FP1, Fp2, Fp3, FPt, Cosφ1, Cosφ2, Cosφ3, Cosφt, F:

TD303 configuration

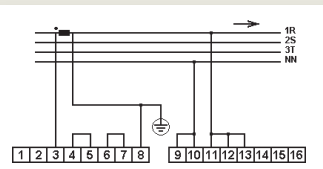

TD304 configuration

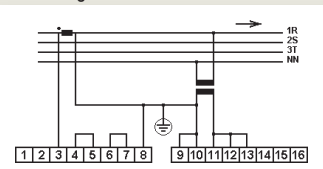

### Unbalanced 3-phase network with 3 wires

I1, I2, I3, U12, U23, U31, P1, P2, P3, Pt, S1, S2, S3, St, Q1, Q2, Q3, Qt, FP1, FP2, FP3, FPt, Cosφ1, Cosφ2, Cosφ3, Cosφt, F:

TD320 configuration

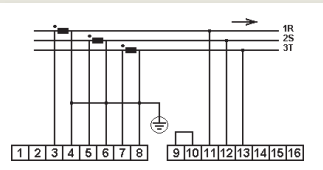

TD320D configuration

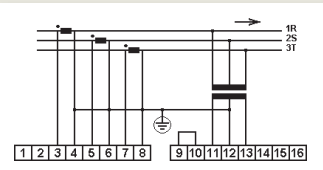

TD320Y configuration

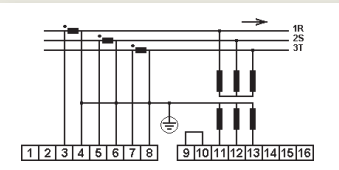

TD324 configuration

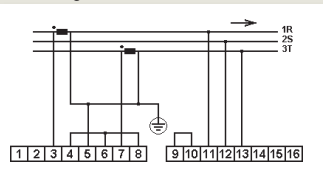

TD324D configuration

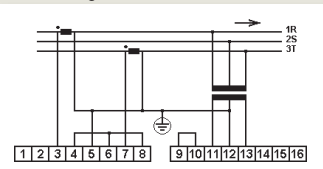

I1, I2, I3:

TD322 configuration

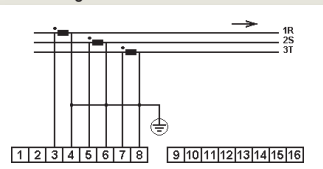

TD323 configuration

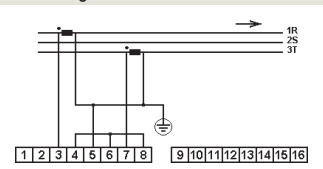

U12, U23, U31:

TD321 configuration

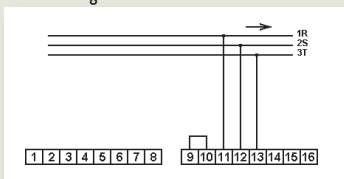

TD321D configuration

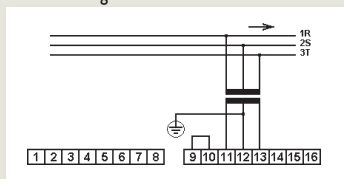

### Unbalanced 3-phase network with 4 wires

I1, I2, I3:

TD314 configuration

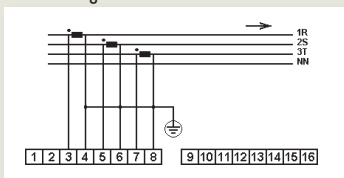

V1, V2, V3, U12, U23, U31, F:

TD317 configuration

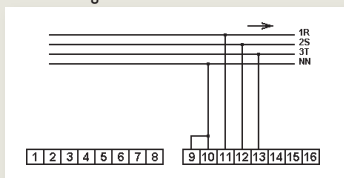

TD317Y configuration

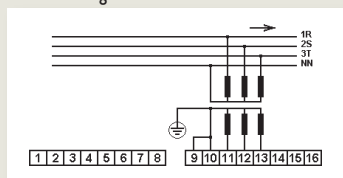

I1, I2, I3, Ineutral:

TD334 configuration

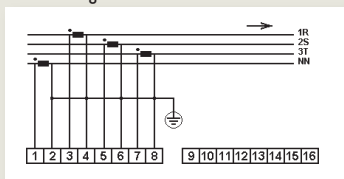

V1, V2, V3, Vearth, U12, U23, U31, F:

TD337 configuration

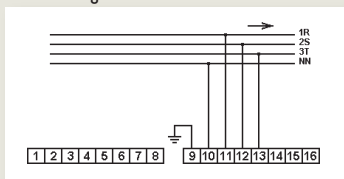

TD337Y configuration

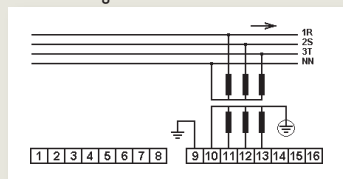

I1, I2, I3, V1, V2, V3, U12, U23, U31, P1, P2, P3, Pt, S1, S2, S3, St, Q1, Q2, Q3, Qt, FP1, FP2, FP3, FPt, Cosφ1, Cosφ2, Cosφ3, Cosφt, F:

TD315 configuration

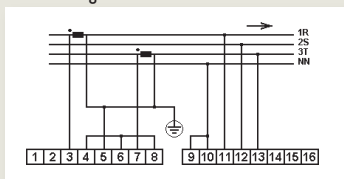

TD315Y configuration

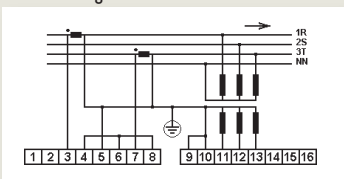

TD318 configuration

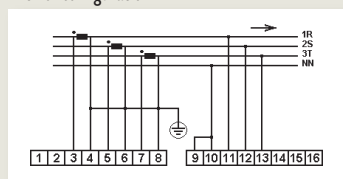

TD318Y configuration

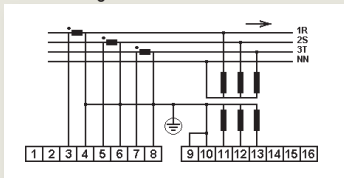

I1, I2, I3, Ineutral, V1, V2, V3, Vearth, U12, U23, U31, P1, P2, P3, Pt, S1, S2, S3, St, Q1, Q2, Q3, Qt, FP1, FP2, FP3, FPt, Cosφ1, Cosφ2, Cosφ3, Cosφt, F:

TD338 configuration

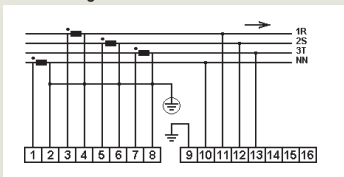

TD338Y configuration

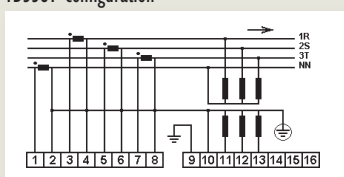



# MICAR 2 Range

The **E.view+** software can be used with the **MICAR 2** range for configuration, installation diagnosis and display of the electrical quantities.

Multi-function digital transducers

Measurement and instrumentation

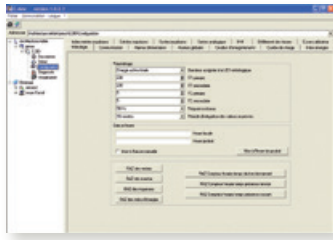

## Configuration

- Configure your MICAR 2 transducers remotely via the RS485, Ethernet or local area network using the optical head
- Program the products' communication parameters and the configuration parameters (CT ratio, VT, alarm thresholds, etc.)

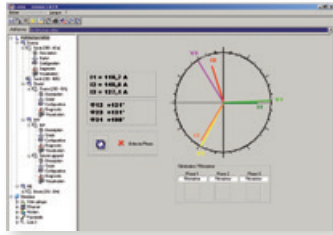

## Diagnosis

- View the phase order and the Fresnel diagram
- Control the analogue and on-off outputs remotely

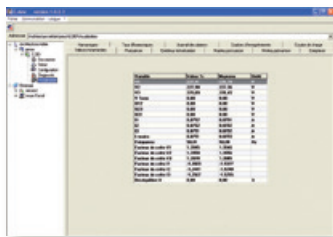

## Display

- View the basic electrical quantities in real time
- View the harmonics in histogram format

## TO ORDER

Product	Code
MICAR with tailored configuration	Complete the order form
Programmable MICAR 2, power supply 80-264 V AC/DC, RS485, 2 analogue outputs (without programming kit)	P01 330 840
Programmable MICAR 2, power supply 80-264 V AC/DC, RS485, 4 analogue outputs (without programming kit)	P01 330 841
Programming kit	Code
MICAR 2 – RS485 kit containing 1 optical head + 1 set of 50 labels + RS485 output + 1 E.view+ CD	P01 330 842
MICAR 2 – Ethernet kit containing 1 optical head + 1 set of 50 labels + Ethernet output + 1 E.view+ CD	P01 330 843
Accessories*	Code
Set of 50 labels for RS485 output	P01 330 844
Set of 50 labels for Ethernet output	P01 330 845

\* labels printable only on laser printers

## ▶ Associated products

Analogue panel meters

▶ page 218



Digital panel meters

▶ page 188



CT Current transformers

▶ page 102



E.view+ software

▶ page 51



## Factory-programmed MICAR 2: order form

## 1 – Network

- Single-phase       Unbalanced 3-phase, 3 wires
- Balanced 3-phase, 3 wires       Unbalanced 3-phase, 4 wires
- Balanced 3-phase, 4 wires

## 2 – Frequency

- 50 Hz  
or  
 60 Hz

## 3 – Connection options

- Ethernet (no RS485)       Tropicalization
- 2 on-off outputs      or       4 on-off outputs

Connection configuration:

TD    

## 4 – Power supply

- 80 to 265 Vac (50/60 Hz) / 80 to 264 Vdc      or       19 to 57 Vdc

## 5 – Inputs

## Current

With current transformer      or      Direct  
Primary      Secondary

/  A       A

## Voltage

With voltage transformer      or      Direct  
Primary      Secondary

/  V       V

Phase-phase       Phase-neutral

## Quantities available

V1 V2 V3 Vearth      U12 U23 U31      I1 I2 I3 Ineutral      P1 P2 P3 Pt      Q1 Q2 Q3 Qt      S1 S2 S3 St

FP1 FP2 FP3 FPt      COSp1 COSp2 COSp3 COSpt      F

## Output 1

## Quantity and measurement range (x)

Indicate the quantity to be measured

Min       Breaking point       Max       Unit <sup>(1)</sup>

## Transfer curve

- Linear
- 2 slopes
- Quadratic

## Output signal (y)

Min       Breaking point       Max  mA

## Output 2

## Quantity and measurement range (x)

Indicate the quantity to be measured

Min       Breaking point       Max       Unit <sup>(1)</sup>

## Transfer curve

- Linear
- 2 slopes
- Quadratic

## Output signal (y)

Min       Breaking point       Max  mA

## Output 3

## Quantity and measurement range (x)

Indicate the quantity to be measured

Min       Breaking point       Max       Unit <sup>(1)</sup>

## Transfer curve

- Linear
- 2 slopes
- Quadratic

## Output signal (y)

Min       Breaking point       Max  mA

## Output 4

## Quantity and measurement range (x)

Indicate the quantity to be measured

Min       Breaking point       Max       Unit <sup>(1)</sup>

## Transfer curve

- Linear
- 2 slopes
- Quadratic

## Output signal (y)

Min       Breaking point       Max  mA

<sup>(1)</sup> Please indicate the unit for the measurement range, e.g. V, kW or MW.

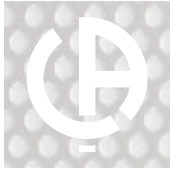

# C.A 3420 range

Universal programmable digital transducer  
DC quantities / physical quantities

Universal digital transducer  
Measurement and instrumentation

## PRODUCT ADVANTAGES

- + Operation in **SIL 2** environment
- + **QUICK, SIMPLE MOUNTING** on **DIN rail**
- + **UNIVERSAL INPUT:** RTD, TC, Ohm, mA, V and potentiometer
- + Intuitive **PROGRAMMING PANEL**
- + **AC and DC POWER SUPPLY** with **WIDE DYNAMIC RANGE**



LCD screen for easy reading



Plug-in C.A 3401 programming panel



LED operating status indicators

## ► Description

The **C.A 3420** can be used to convert any input signal into a stable, standardized low-level DC voltage or current signal : temperatures from thermocouples or thermometric resistors, linear resistances from potentiometers, voltages (mVdc et Vdc) and currents (mA<sub>dc</sub>) for DC networks.

When used with the C.A 3401 programming panel, the **C.A 3420** transducer is particularly flexible, covering more than a hundred industrial applications.

Usable in installations rated SIL 2 (Safety Integrity Level), the **C.A 3420** guarantees high reliability and safety:

- 2.3 kVac triple galvanic insulation between the input, the power supply and the output
- Advanced sensor error detection with alarm / relay output or analog output
- Programming protected by password (C.A 3401)

## ► Technical specifications

Input	
mA input	0/4...20 mA
V input	0/0,2...1 V ; 0/1...5 V ; 0/2...10 V
RTD	2, 3 and 4 wires Pt10...Pt100...Pt1000 Ni50...Ni1000 Cu10...Cu100
CT types	B, E, J, K, L, N, R, S, T, U, W3, W5, LR
Potentiometer	10 Ω... 100 kΩ
Linear resistance	0 Ω... 10 kΩ
Outputs	
2 relay outputs	250 VRMS / 2 A
mA output	0/4...20 mA (max. 800 Ω / 16 V)
V output	0/0,2...1 ; 0/1...5 ; 0/2...10 Vdc
Mechanical dimensions	
Power supply	21,6...250 Vac, 50...60 Hz or 19,2... 300 Vdc
Protection	IP20
Dimensions, without/with C.A 3401 (H x L x W)	109 x 23.5 x 104/116 mm
Weight, without/with C.A 3401	170 g / 185 g
Mounting	DIN rail
Approvals and certifications	CE / Standards: EN 61010-1, EN 61326-1 SIL
Environment	
Operating temperature	-20 °C to +60°C
Relative humidity	< 95 % RH

## ► Connection diagrams

### Input signals:

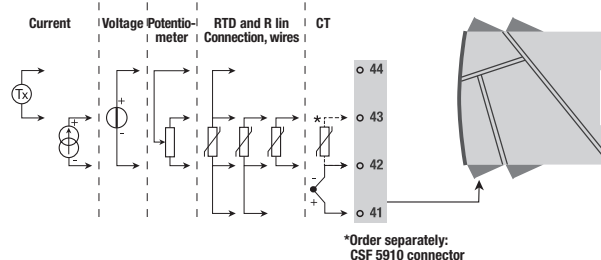

### Output signals:

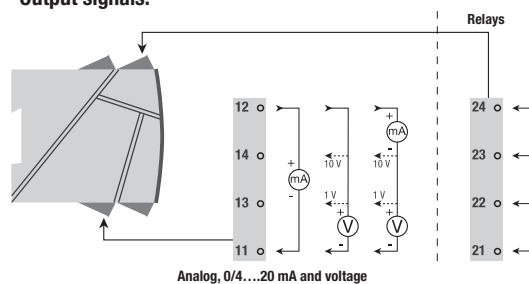

### Power supply:

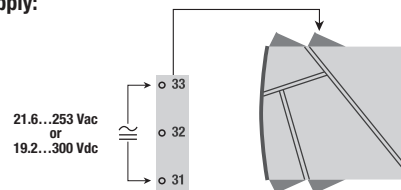

## TO ORDER

Model	Description	Reference
Pack	Transducer + panel pack	P01 6760 20

## ► Associated products

Analogue  
panel meters

► page 218



Digital  
panel meters

► page 188



CT Current  
transformers

► page 102



Thermocouple / probe

► Pyrocontrole catalogue







# TSP 2 Range

Self-powered version for applications requiring the conversion of a single AC current or voltage quantity. 1 analogue output class 0.2 for all type of electrical network

Measurement and instrumentation Analogue transducers

**PRODUCT ADVANTAGES**

- +** SELF-POWERED
- +** CLASS 0.2
- +** WIDE CHOICE OF INPUTS CALIBRED
- +** RESPONSE TIME of 100 ms for TSPI and 200 ms for TSPU



Accessibility and safety:  
large-dimension terminals  
Insulated circuits



Ergonomic: easy mounting on  
DIN rail or switchboard

## ► Main specifications

### TSPU

**Quantity measured:** Vac, Uac

**Accuracy:** Class 0.2

**Inputs:** AC voltage: 57.5V to 400V (fixed calibres)

**Analogue output calibres:** 0-10 mA, 0-20 mA, 0-5 V, 0-10 V

**Operating frequency:** 45 to 65 Hz

### TSPI

**Quantity measured:** Iac

**Accuracy:** Class 0.2

**Inputs:** AC current: 1 A or 5 A (fixed calibres)

**Analogue output calibres:** 0-10 mA, 0-20 mA

**Operating frequency:** 45 to 65 Hz

## ► Functions

Network	Function	TSPi model	TSPU model
Single phase	V		•
	I	•	
Balanced 3-phase 3 wires	U12 or U23 or U31		•
	I1 or I2 or I3	•	
Balanced 3-phase 4 wires	V1 or V2 or V3 or U12 or U23 or U31		•
	I1 or I2 or I3	•	
Unbalanced 3-phase 3 wires	U12 or U23 or U31		•
	I1 or I2 or I3	•	
Unbalanced 3-phase 4 wires	V1 or V2 or V3 or U12 or U23 or U31		•
	I1 or I2 or I3	•	

## ► Electrical connections

### TSPU

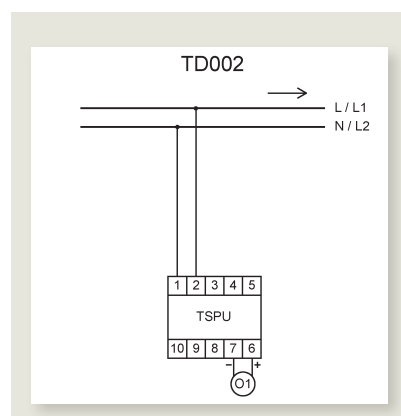

### TSPi

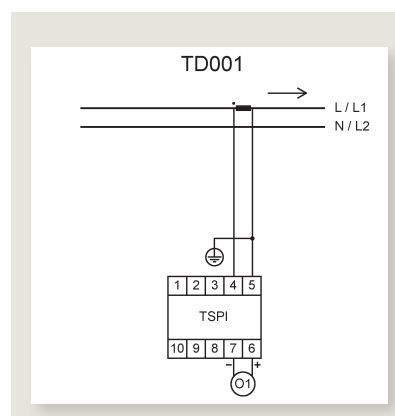

 The terminal 1 can be connected either on the neutral or on one phase of the electrical network



# TSP 2 Range

## ► Dimensions (in mm)

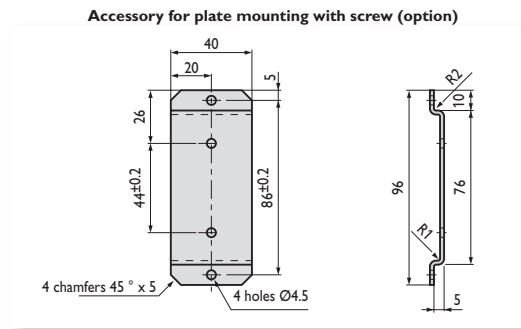
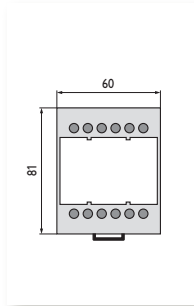
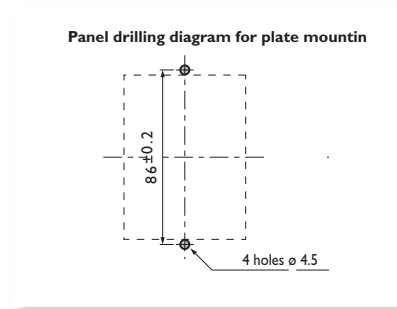
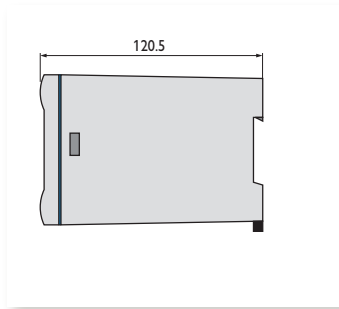

## ► Environment and standards

Standard of reference: IEC 60688	
EMC IMMUNITY	
Shock voltage	IEC 61000-4-5
Oscillating wave	IEC 61000-4-12
Fast electrical transients in bursts	IEC 61000-4-4
Electrostatic discharge	IEC 61000-4-2
EM radiated field	IEC 61000-4-3

Climatic specifications (IEC 60068 2-1 / 2-2 / 2-30)	
Operating temperature	-10°C to +55°C
Storage temperature	-40°C to +70°C
Relative humidity	≤ 95% at 55°C

Safety specifications (IEC 61010-1)	
Installation category	3
Pollution level	2
Fire resistance	UL94, severity V0

Mechanical specifications	
Protection rating	IP 20
Mechanical shocks	IEC 60068-2-27
Vibrations	IEC 60068-2-6
Drop test with packaging	NF H0042-1

## ► Mounting accessories

Model	Reference
Plate mounting	ACCT 1007

## ► Casing

Weight	320 g
Mounting	DIN rail 43700 or plate mounting
Connection	Terminals with mobile stirrup clamp with screw for 4 single-wire 6 mm <sup>2</sup> conductors or 2 multi-wire 4 mm <sup>2</sup> conductors

## ► Electrical and metrological specifications

Model	TSPI I (rms)	TSPU U or V (rms)
<b>Current or voltage input</b>		
Rated value	$I_n = 1 \text{ or } 5 \text{ A}$	$V_n = 100/\sqrt{3}, 110/\sqrt{3}, 120/\sqrt{3} \text{ V}$ $U_n = 100, 110, 120, 230, 400 \text{ V}$
Frequency $f_n$	46..65 Hz	46..65 Hz
Measurement range 0...Xmax	0...100% of $I_n$	0...100% of $U_n/V_n$
Consumption	2 VA	2 VA
Maximum overloads	2 $I_n$ permanent 20 $I_n / 1 \text{ s}$ 40 $I_n / 0.5 \text{ s}$	1.5 $U_n$ permanent 2 $U_n / 1 \text{ s}$ 4 $U_n / 0.5 \text{ s}$
<b>Analogue output</b>		
Transfer curve	linear	
0...Ymax	0...10 mA 0...20 mA	0...10 mA 0...20 mA 0...5 V 0...10 V
Accuracy	Class 0.2: 10...100% of $I_n$	Class 0.2: 50...100% of $V_n / U_n$
Response time	< 100 ms	< 200 ms
Operating resistance	15 V /Is	$\geq 1 \text{ k}\Omega$
Peak-peak residual wave	40 $\mu\text{A}$	20 mV
<b>Auxiliary power supply</b>		
Self-powered	•	•

 Parameters to be indicated when ordering

### TO ORDER

Input	Output	Tropicalization	
		with	without
0...1 A	0...10 mA	P01 3751 01	P01 3751 05
	0...20 mA	P01 3751 02	P01 3751 06
0...5 A	0...10 mA	P01 3751 03	P01 3751 07
	0...20 mA	P01 3751 04	P01 3751 08

Input	Output	TSPU	
		with	without
0...57.7 V	0...10 mA	P01 3752 01	P01 3752 33
	0...20 mA	P01 3752 02	P01 3752 34
	0...5 V	P01 3752 03	P01 3752 35
	0...10 V	P01 3752 04	P01 3752 36
0...63.5 V	0...10 mA	P01 3752 05	P01 3752 37
	0...20 mA	P01 3752 06	P01 3752 38
	0...5 V	P01 3752 07	P01 3752 39
	0...10 V	P01 3752 08	P01 3752 40
0...69.3 V	0...10 mA	P01 3752 09	P01 3752 41
	0...20 mA	P01 3752 10	P01 3752 42
	0...5 V	P01 3752 11	P01 3752 43
0...76.2 V	0...10 V	P01 3752 12	P01 3752 44
	0...10 mA	P01 3752 65	P01 3752 66
	0...10 mA	P01 3752 13	P01 3752 45
0...100 V	0...20 mA	P01 3752 14	P01 3752 46
	0...5 V	P01 3752 15	P01 3752 47
	0...10 V	P01 3752 16	P01 3752 48

Input	Output	TSPU	
		with	without
0...110 V	0...10 mA	P01 3752 17	P01 3752 49
	0...20 mA	P01 3752 18	P01 3752 50
	0...5 V	P01 3752 19	P01 3752 51
0...120 V	0...10 V	P01 3752 20	P01 3752 52
	0...10 mA	P01 3752 21	P01 3752 53
	0...20 mA	P01 3752 22	P01 3752 54
	0...5 V	P01 3752 23	P01 3752 55
0...230 V	0...10 V	P01 3752 24	P01 3752 56
	0...10 mA	P01 3752 25	P01 3752 57
	0...20 mA	P01 3752 26	P01 3752 58
	0...5 V	P01 3752 27	P01 3752 59
0...400 V	0...10 V	P01 3752 28	P01 3752 60
	0...10 mA	P01 3752 29	P01 3752 61
	0...20 mA	P01 3752 30	P01 3752 62
	0...5 V	P01 3752 31	P01 3752 63
	0...10 V	P01 3752 32	P01 3752 64



# Digital panel meters, recorder

▲ Measurement and instrumentation

## $\mu$ DIGI1 and $\mu$ DIGI2 ranges \_\_\_\_\_

$\mu$ DIGI1  
▶ page 194



$\mu$ DIGI2  
▶ page 198



## C.A 2150 and C.A 2200 ranges \_\_\_\_\_

C.A 2150  
▶ page 202



C.A 2200  
▶ page 206



# and synchrocoupler

## ENERTRACE - Graphic recorder



Plug & play  
▶ page 210

## Synchrocoupleur

Synchronization instruments  
▶ page 214







# Selection guide

▲ Measurement and instrumentation Digital panel meters

## μDIGI1 & μDIGI2 ranges

▶ page 194



▶ page 198



		μDIGI1	μDIGI2
Format of front panel		24 x 48	48 x 96
Display resolution (counts)		32000	32000
Display range (counts)		-1,999 / +9,999	-1,999 / +9,999
Measurement functions	AC ammeter	μDIGI1 E	μDIGI2 E
	AC voltmeter	μDIGI1 E	μDIGI2 E
	Frequencymeter	μDIGI1 F	
	DC ammeter	μDIGI1 E	μDIGI2 E
	DC voltmeter	μDIGI1 E	μDIGI2 E
	Process signals	μDIGI1 P/LP	μDIGI2 P
	Thermocouple thermometer	μDIGI1 T	μDIGI2 P
	Pt 100 thermometer		μDIGI2 P
	Ohmmeter		μDIGI2 P
	Tachometer	μDIGI1 F	μDIGI2 TAC
	Meter		
	Timer		
	Load cell		
	Potentiometer		μDIGI2 P
Special functions	MIN/MAX	μDIGI1 ALP	
Output(s)	Analogue output		
	RS232 output		
	RS485 output	μDIGI1 ALP	
	Threshold output(s)		Option
	BCD output		
User-programmable			
<b>Strengths</b>		Economical programmable range for industrial use.	

## C.A 2150 & C.A 2200 ranges

► page 202



► page 206



CA 2150	CA 2200
48 x 96	48 x 96
32000	65000
-19,999 / +19,999	-32,000 / +32,000
C.A 2150-E	
C.A 2150-E	
C.A 2150-D	C.A 2200-D
C.A 2150-E	
C.A 2150-E	
C.A 2150-M	C.A 2200-P
C.A 2150-M	C.A 2200-T
C.A 2150-M	C.A 2200-T
C.A 2150-D	C.A 2200-D
C.A 2150-D	C.A 2200-D
C.A 2150-D	C.A 2200-D
C.A 2150-M	C.A 2200-C
C.A 2150-M	C.A 2200-P
Option	Option
Option	Option
Option	Option
Option	Option
	Option
Programmable range for universal use.	

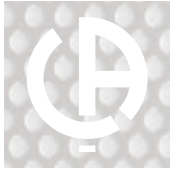

# Info & advice

Measurement and instrumentation Digital panel meters

Digital panel meters are used to display an analogue value clearly and precisely. The digital processing enables these instruments to display different values, and allows connection to external measurement or supervision systems.



Several criteria influence the choice of a digital panel meter, the first being the scale or the measurement range, defined by the variation range of the signal to be measured.

### The resolution

The number of display counts defines the resolution of the panel meter. The resolution is the necessary variation of the measurement signal required to vary the reading by one point. For a given rating, the greater the display capacity, the better the resolution.

For example, for an 11-bit (2,000-counts) panel meter with a 20V range, the resolution is 10 mV.

However, for industrial applications, it is not always wise to choose a digital panel meter of too high resolution. The measurement signal may be subject to noise interference, resulting in the permanent instability of lightweight display units.

### Accuracy

Accuracy, which is not to be confused with resolution, defines the maximum variation between the instrument reading and the true value of the signal measured.

It is expressed as follows:  
 $E = x\% \text{ of the reading} \pm y \text{ counts.}$

The first term depends on the conversion method and the precision of the components, while the second depends on the various drift, dispersion, fluctuation and noise factors that can affect the instrument. The error is therefore constant over the entire measurement range. This is one of the main advantages of the digital panel meter over the galvanometer, where the most accurate readings are obtained at the end of the scale.

### Format

The format and weight of the instrument must also be taken into account, as they affect the sizing of electrical cabinets. The format 48x96 (DIN standard 43700) is the industrial standard. Alongside this, panel meters of reduced dimensions, such as the 25x75, have proven especially useful for smaller-sized machines and embedded equipment.

## Display

The visibility of panel meter display characters is directly linked to the light difference between the digits and the screen background. LEDs, LCDs and backlit LCDs offer different levels of readability. LED technology, used on most of the ENERDIS range of digital panel meters, offers the best display contrast. A choice of red, green and amber colours also ensures they are easy to read.

## Display only or multifunction products?

Panel meters are increasingly universal, and must be able to display both strong signals, such as the voltage of a network, and weak signals such as process signals.

Instruments with multiple inputs, calibres and outputs are increasingly equipped with digital interfaces (RS232, RS485) for remote communication, analogue outputs, and relay or alarm interfaces for connection to logic controllers.

## Number of digits and display counts

The display of a digital panel meter is characterized by the number of digits. We speak, for example, of 3 1/2 digit or 4 3/4 digit panel meters.

A full digit has 10 possible states, in other words all values between 0 and 9.

A 1/2 digit has a maximum value of 1 and is capable of 2 states: 0 and 1.

A 3/4 digit can display a maximum value equal to 3 and has 4 states: 0, 1, 2, 3.

We can therefore expect a 3 1/2 digit panel meter to be capable of counting up to 2,000 (0 to 1,999), and a 4 3/4 digit panel meter to be capable of counting up to 40,000 (0 to 3,999). For this, the real display range of the apparatus must not be inferior.

## FOCUS

### How to get the best out of your panel meter

#### ► Environment

Digital panel meters, in general, are intended for indoor use, their electronic circuit being sensitive to difficult climatic environments (in contrast to analogue panel meters, which are suitable for both indoor and outdoor use). They must also support emissions stimulated and emitted by the electrical equipment.

#### ► Maintenance

Unlike the analogue panel meter, the digital panel meter accepts low currents (maximum 600 V and 5 A). It therefore requires minimal precautions for the use of currents and voltages.

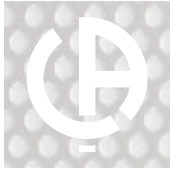

# μDIGI1 Range

24 x 48 mm programmable panel meters for industrial use

Measurement and instrumentation Digital panel meters

**PRODUCT ADVANTAGES**

- + **SIMPLE PROGRAMMING**  
using 3 keys
- + **Instant MOUNTING WITHOUT TOOLS**
- + **COMPACT DIMENSIONS**
- + **16-POINT LINEARIZATION**  
of the input signals and display with **4 LEVELS OF BRIGHTNESS** for μDIGI1-ALP



Plug-in connectors for quick and easy connection



Display with 4 levels of brightness



Remote configuration of the μDIGI1-ALP via the RS485 serial link

## ► Programming

Quick and easy:

- **Local** programming using the 3 keys of the keyboard. Only the instructions required for the application are shown. No mistakes are possible. Access to programming can be protected on all the instruments.

- **Remote** programming with the **μDIGI1-PRG** software available free from [www.enerdis.com](http://www.enerdis.com) for the μDIGI1-ALP with RS485 option.

## μDIGI1-LP

4-20 mA  
process signal

- **Input:**  
4-20 mA
- **Display range:**  
-1,999...+9,999

Power supply	Reference
Self-powered (active loop)	P01 330 000

## μDIGI1-T

Temperature (Pt100  
and thermocouple)

- **Pt100:** -200... +800°C  
-100... +200°C  
-328... +1,472°F  
-148... +392°C
- **J:** -50... +850°C  
-58... +1,562°F
- **K:** -50... +1,250°C  
-58... +2,282°F
- **T:** -200... +400°C  
-328... +752°F
- **Display range:**  
-1,999... 9,999

Power supply	Reference
85 - 265 Vac & 100 - 300 Vdc	P01 330 041
22 - 53 Vac & 10.5 - 70 Vdc	P01 330 042

## μDIGI1-P

U/I process signal

- **Input:**  
-10... +10 Vdc  
-20... +20 Vdc  
-200... +200 Vdc (1 MΩ)  
-100... +100 mVdc (100 MΩ)  
-20... +20 mAdc (12.1 Ω)
- **Display range:**  
-1,999... 9,999

Power supply	Reference
85 - 265 Vac & 100 - 300 Vdc	P01 330 031
22 - 53 Vac & 10.5 - 70 Vdc	P01 330 032

## μDIGI1-F

Frequency,  
rpm, pulse

- **Frequency meter:**  
0.01 Hz... 7 KHz (voltage 10 to 600 Vac)
- **Tachometer:**  
*Magnetic*  
Vin > 30 mV rms (60 Hz)  
Vin > 300 mV rms (6 kHz)  
*NAMUR*  
Rc = 1.5 kΩ; Ion < 1 mA ; Ioff > 3 mA  
*NPN/PNP*  
Rc = 3.9 kΩ (NPN); 1.5 kΩ (PNP)  
"0" < 2.4 V / "1" > 2.6 V  
*Encoder/TTL/24V*  
"0" < 2.4 V / "1" > 2.6 V  
*SWITCH*  
Vc = 5 V (internal)  
Rc = 3.9 kΩ (internal)  
Fc = 20 Hz
- **Display range:**  
0... 9,999

Power supply	Reference
85 - 265 Vac & 100 - 300 Vdc	P01 330 021
22 - 53 Vac & 10.5 - 70 Vdc	P01 330 022

## μDIGI1-E

U/I voltage  
and current

- **Input:**  
600 Vac  
100 Vac  
-199,9... +600 Vdc  
-100... +100 Vdc (3 MΩ)  
5 Aac  
1 Aac  
-1,999... +5 Adc  
-1... +1 Adc (14 mΩ)
- **Display range:**  
-1,999... 9,999 (dc)  
-0... 9,999 (ac)

Power supply	Reference
85 - 265 Vac & 100 - 300 Vdc	P01 330 011
22 - 53 Vac & 10.5 - 70 Vdc	P01 330 012

## μDIGI1-ALP

Process signal  
with alarms

- **Input:**  
-10... +10 Vdc  
-60... +60 Vdc (1 MΩ)  
-100... +100 mVdc (100 MΩ)  
-20... +20 mAdc (12.1 mΩ)
- **Display range:**  
-1,999... 9,999
- **15-segment signal  
linearization**
- **Display with 4 levels  
of brightness**

Power supply	Option	Reference
85 - 265 Vac & 100 - 300 Vdc	-	P01 330 051
22 - 53 Vac & 10.5 - 70 Vdc	-	P01 330 052
85 - 265 Vac & 100 - 300 Vdc	RS485	P01 330 061
22 - 53 Vac & 10.5 - 70 Vdc	RS485	P01 330 062



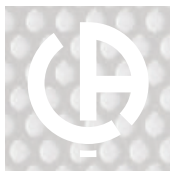

# μDIGI1 Range

24 x 48 mm programmable panel meters for industrial use

Digital panel meters

Measurement and instrumentation

## ► Display

	μDIGI1-LP	μDIGI1-P	μDIGI1-E	μDIGI1-T	μDIGI1-F	μDIGI1-ALP
Display resolution	32,000 counts					
Measurement rate	62/s	25/s				
Display range	-1,999... 9,999	-1,999... 9,999	-1,999... 9,999 (dc) 0... 9,999 (ac)	-1,999... 9,999	0... 9,999	-1,999... 9,999
7-segment red LED display	Height 10 mm					Height 8 mm
Reading	4 digits					
Polarity	Automatic					
Overrun	OVE display					
Decimal position	Programmable using software					

## ► Accuracy

μDIGI1-LP	±0.1% +3 counts
μDIGI1-P	
μDIGI1-E	
μDIGI1-T	<b>Pt 100</b> °C: ±0.2% + 1 count (Res 1°) - ±0.2% +4 counts (Res 0.1°) °F: ±0.2% + 2 counts (Res 1°) - ±0.2% +7 counts (Res 0.1°) <b>J, K and T thermocouples</b> °C: ±0.4% + 2 counts (Res 1°) °F: ±0.4% + 4 counts (Res 1°)
μDIGI1-F	±0.01% +1 count
μDIGI1-ALP	±0.1% +1 count

## ► Mechanical specifications

Material	Polycarbonate as per UL94 V-0
Weight	60 g – 40 g (μDIGI1-LP) – 70 g (μDIGI1-ALP)
Protection rating	Front panel IP 65
Mounting	On panel with self-locking strap

## ► Environment

Operating temperature	-10°C to +60°C
Storage temperature	-25°C to +85°C
Relative humidity	< 95% at +40°C
Max. altitude	2,000 m

## ► Power supply

High level	85/265 Vac 50/60 Hz - 100/300 Vdc
Low level	22/53 Vac 50/60 Hz - 10.5/70 Vdc
Consumption	≤ 2.2 W (< 3 W for μDIGI1-ALP)

## ► Standards

Insulation — dielectric strength: EN 611010-1 (category II installation)

EMC — immunity/emission: EN 61000-4-2, EN 61000-4-3, EN 61000-4-4 / EN 55022

(EN 610000-4-6 for  $\mu$ DIGI1-LP and  $\mu$ DIGI1-ALP — EN 61000-4-5 and EN 61000-4-11 for  $\mu$ DIGI1-ALP)

## ► Dimensions (in mm)

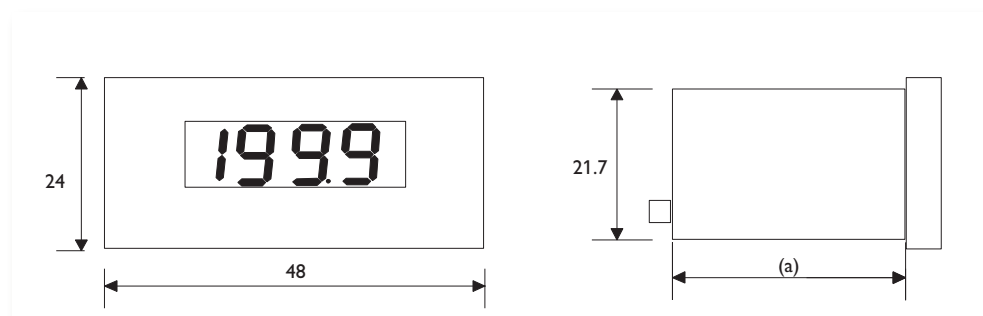

	$\mu$ DIGI1-LP	$\mu$ DIGI1-P	$\mu$ DIGI1-E	$\mu$ DIGI1-T	$\mu$ DIGI1-F	$\mu$ DIGI1-ALP
(a)	40 mm		70 mm			100 mm

## ► Panel drilling specifications (in mm)

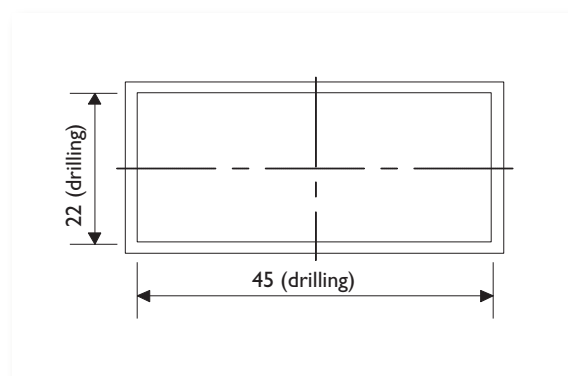

## ► Associated products

Current transformers  
& shunts

► page 102



Tachometric  
sensor

► Contact us



Thermocouple /  
probe

► Pyrocontrol Catalogue





# μDIGI2 Range

Programmable panel meters in 48 x 96 mm format for industrial applications

Digital panel meters  
 Measurement and instrumentation

**PRODUCT ADVANTAGES**

- +** **ECONOMICAL**  
single-function range
- +** **INSTANT FITTING**  
without tools



Simple programming with 3 keys on front panel



Accessories for surface and DIN rail mounting

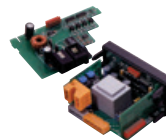

Easy installation of option boards



Quick connection using plug-in connectors

## ▶ Mounting accessories

	Reference
Multi-position fitting with DIN rail adapter	P01 3194 01
Back fitting with 2 DIN rail adapters	P01 3194 02

## ▶ Option boards

	Reference
2-relay alarm board	P01 3193 01

## μDIGI2 E

- **DC voltage:**  
600 V  
200 V  
20 V
- **DC current:**  
5 A  
1 A  
100 mV  
60 mV
- **AC voltage:**  
600 V  
200 V  
20 V
- **AC current:**  
5 A  
1 A  
100 mV  
60 mV

Supply	Reference
20/265 Vac - 11/265 Vdc	P01330081

## μDIGI2 P

- **Process:**  
±20 mA  
10 V  
200 V  
dynamo-tachometer
- **Temperature:**  
Thermocouple J  
Thermocouple K  
Thermocouple T  
Thermocouple N  
Pt 100  
Pt 1000
- **Potentiometer:**  
100 Ω to 100 kΩ
- **Resistance:**  
1 kΩ  
10 kΩ  
50 kΩ

Supply	Reference
20/265 Vac - 11/265 Vdc	P01330080

## μDIGI2 TAC

- **Frequency:**  
0 to 999.9 Hz
- **Speed:**  
0 to 9,999 counts
- **Magnetic sensor:**  
Vin > 120 mVrms
- **NAMUR sensor**
- **Encoder TTL/24V**  
or NPN/PNP
- **Dry contact**
- **Voltage:**  
0 to 10 Vac

Supply	Reference
115/230 Vac (3 VA)	5330 081F
24/48 Vac (3 VA)	5330 082F
12 Vdc (3 W)	5330 083F
24 Vdc (3 W)	5330 084F
48 Vdc (3 W)	5330 085F

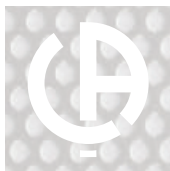

# μDIGI2 Range

Programmable panel meters in 48 x 96 mm format for industrial applications

Digital panel meters  
Measurement and instrumentation

## ► Display

Display resolution	32,000 counts
Display range	-9,999...9,999 (TAC: 0... 9,999)
Display indicators	Red LED 7 segments
	Height 14 mm
Reading	4 digits
Polarity	Automatic
Overrun	OVE displayed
Decimal position	Programmable by software
Measurement rate	20 measurements / second (TAC: 0.1 Hz to 7 kHz)

## ► Accuracy

Vdc, Adc, Aac		±0.05% R
	±20 V	±0.1% R
Vac	±200 V	±0.25% R
	±600 V	±0.35% R
Process signal		±0.1% R
Temperature	Thermocouple J, K, N	±0.1% R
	Thermocouple T	±0.2% R
	PT 100 / PT 1000	±0.15% R
Potentiometer		±0.1% R
Resistance		±0.1% R
Tachometer		±0.1% ±3 counts

## ► Mechanical specifications

Material	Polycarbonate V0 as per UL94
Weight	150 g
Protection rating	IP 65 on front panel
Fitting	On panel using strap

## ► Environment

Operating temperature	-10°C to +60°C
Storage temperature	-25°C to +85°C
Relative humidity	< 95% at +40°C
Maximum altitude	2,000 m

## ► Power supply

Voltage	20/265 Vac - 50/60 Hz – 11/265 Vdc
Consumption	3 VA / 3 W

## ► Standard

Low voltage directive 73/23/CEE

Insulation - dielectric strength IEC 61010-1

## ► Dimensions (in mm)

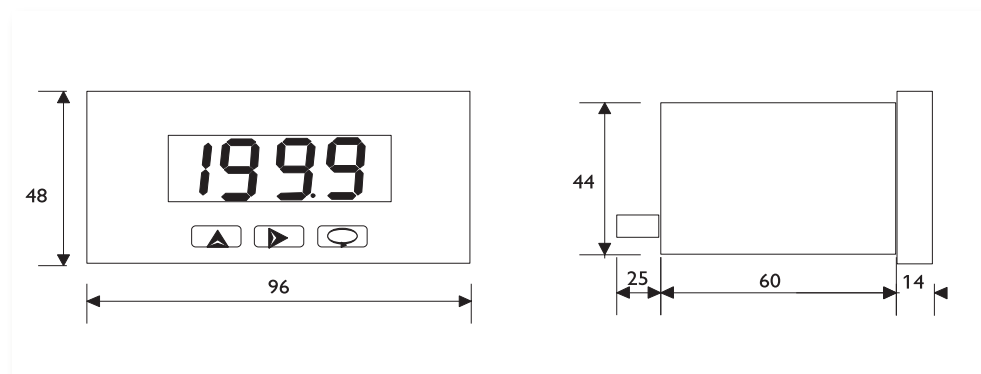

## ► Panel drilling specifications (in mm)

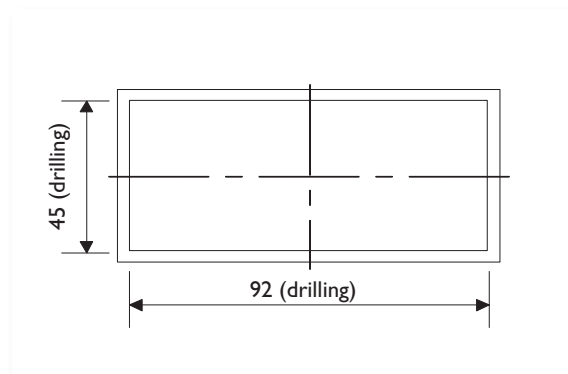

## ► Associated products

Accessories  
and option boards

► page 198



CT Current  
transformers and shunts

► page 102



Tachometer  
probe

► Contact us



Thermocouple / probe

► Pyrocontrole Catalogue







# C.A 2150 Range

48 x 96 mm programmable digital panel meters for all types of industrial applications

Measurement and instrumentation Digital panel meters

**PRODUCT ADVANTAGES**

- + MULTI-FUNCTION PRODUCTS**
- + 3 DISPLAY COLOURS**
- + 4 ALARMS as standard**
- + INSTANT MOUNTING WITHOUT TOOLS**
- + SERIAL LINK for remote processing of the measurements**



3 display colours



Remote configuration via the RS232 or RS485 serial link



Quick connection using plug-in connectors (spring-cage type)

## ► Description

The **C.A 2150-E** is a programmable multi-rating panel meter which measures TRMS Vac or Iac quantities and Vdc or Idc quantities.

The **C.A 2150-M** is a 4-in-1 programmable panel meter which can be configured for process, temperature, load cell or potentiometer signals.

The **C.A 2150-D** is a 4-in-1 programmable panel meter which can be configured for the following applications: meter, tachometer, frequency meter and chronometer.

The serial link can be used to transfer the measurements onto a PC.

The CA2150-PRG software, available free of charge from [www.enerdis.com](http://www.enerdis.com), can be used to read the measurement directly, configure and remotely program one or more connected panel meters.

It can also be used to save and recover the configuration of an existing panel meter.

## ► Option boards\*

Model	Reference
C.A 2XXX AL 2-relay board	P01 3193 01
C.A 2XXX AL 4-relay board	P01 3193 03
C.A 2XXX 4 NPN board	P01 3193 04
C.A 2XXX COM RS232 board	P01 3193 06
C.A 2XXX COM RS485 board	P01 3193 07
C.A 2150 0 – 10 V output board	P01 3193 10
C.A 2150 4 – 20 mA output board	P01 3193 11

\* Extra boards (addition or replacement)

## ► Accessories

Model	Reference
Multi-position mounting with 2 DIN rail adapters	P01 3194 01
Connector + 1 m RS232 cable	P01 3194 03
Connector + 1 m RS485 cable	P01 3194 04

## C.A 2150-E

### AC input voltage rating (TRMS)

- 2 V with 75 kΩ
- 20 V, 200 V or 600 V with 850 kΩ

### AC input current rating (TRMS)

- 200 mA with 0.75 Ω
- 1 A or 5 A with 0.014 Ω
- 50 mV, 60 mV or 100 mV with 1.5 MΩ

### DC input voltage rating

- 2 V with 100 kΩ
- 20 V, 200 V or 600 V with 850 kΩ

### DC input current rating

- 200 mA with 0.75 Ω
- 1 A or 5 A with 0.014 Ω
- 50 mV, 60 mV or 100 mV with 1.8 MΩ

## ► Available options

### Relay card

	Board with 2 alarms on relays	Board with 4 alarms on relays	Board with 4 alarms on NPN
Outputs	2 x 1RT relays	4 x 1RT relays	4 NPN optocouplers
Max. voltage	250 Vac or 12 Vdc	250 Vac or 125 Vdc	50 Vdc
Max. current	8 A at 250 Vac or 8 A at 24 Vdc	500 mA at 125 Vac or 1 A at 30 Vdc	50 mA at 50 Vdc

### Communication board

Type of link	RS232C	RS485
Protocol	ISO1745, C.A protocol or ModBus/RTU	
Speed	1,200, 2,400, 4,800, 9,600 or 19,200 bauds	
Output connector	RJ9-4	RJ11-6 with dual adapter (input + output)

### Analogue output board

Output	0... 10 V	4... 20 mA
Accuracy	0.1% ±1 digit	
Temperature coeff.	0.2 mV per K	0.5 μA per K
Charge maxi	> 500 Ω	< 800 Ω

## ► Customized product

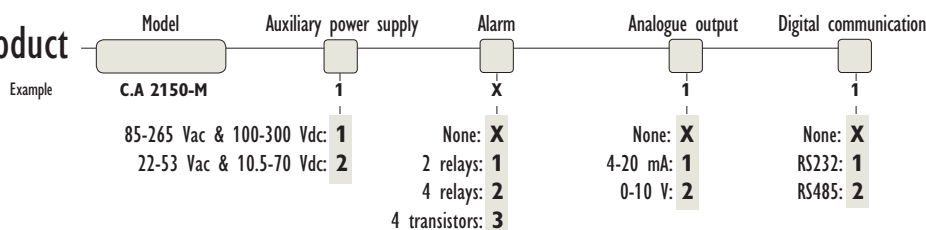

## C.A 2150-M

### DC U/I process signals

- **Voltage:** 0...±10 V with 1 mΩ
- **Current:** 0...±20 mA with 15 Ω

### Temperature

- J thermocouple: -50...+800°C / -58...+1472°F
- K thermocouple: -50...+1,200°C / -58...+2,192°F
- T thermocouple: -150...+400°C / -302...+752°F
- Pt 100: -100...+800°C / -148...+1,472°F

### Load cells

- 0...±15 mV with 100 mΩ
- 0...±30 mVdc with 100 mΩ
- 0...±150 mV with 100 mΩ

### Potentiometer

- 200 Ω...100 kΩ

## C.A 2150-D

### Frequencymeter / Tachometer

- **Fmin:** 0.01 Hz
- **Fmax without relay option:** 19 kHz
- **Fmax with relay option:** 9.9 kHz

### Meter / Chronometer

- **Fmax without relay option:** 20 kHz
- **Fmax with relay option:** 15 kHz

### Types of inputs:

- **Voltage:** 10...300 Vac
- **Magnetic sensor:** Vin > 60 mVrms (F < 1 kHz)  
Vin > 120 mVrms (F > 1 kHz)
- **NAMUR sensor:** Rc = 3.3 kΩ  
Ion < 1 mAdc  
Ioff > 3 mAdc
- **TTL encoder/24 Vdc:**  
"0" < 2.4 Vdc / "1" > 2.6 Vdc  
Rc = 3.3 kΩ
- **Dry contact:**  
Vc = 5 Vdc / Rc = 3.9 kΩ / Fc = 20 Hz

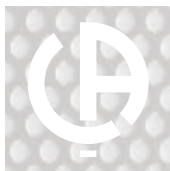

# C.A 2150 Range

48 x 96 mm programmable digital panel meters

Digital panel meters

Measurement and instrumentation

## ► Display

	C.A 2150-E	C.A 2150-M			C.A 2150-D		
Display resolution	32,000 counts	32,000 counts			32,000 counts		
Measurement rate	50 ms	Process/load	Pt100	Tc	Meter/chrono	Freq./Tacho.	
		50 ms	250 ms	100 ms	100 ms	0.1 to 9.9 s	
Display range	± 19,999	± 19,999			Meter	Chrono	Freq./Tacho.
					± 99,999	0 to 999.9	0 to 99,999
Displays	7-segment programmable colour LED (red, green, amber), height 14 mm						
Reading	5 digits						
Polarity	automatic						
Overrun	OvEr / -OvEr						
Decimal position	by programming						

## ► Sensor excitation

24 Vdc	Process (60 mA)	(30 mA)
10 Vdc / 5 Vdc	(60 mA)	
8 Vdc		(30 mA)
< 1 mAdc	Pt100	

## ► Mechanical specifications

Material	polycarbonate as per UL 94 V-0
Weight	160 g (C.A 2150-E: 135 g)
Protection rating	IP 65 on front panel
Mounting	On panel using self-locking strap

## ► Environment

Operating temperature	-10°C to +60°C
Storage temperature	-25°C to +80°C
Relative humidity	< 95% at 40°C
Maximum altitude	2,000 m

## ► Power supply

High level	85/265 Vac 50/60 Hz - 100/300 Vdc
Low level	22/53 Vac 50/60 Hz - 10.5/70 Vdc
Consumption	5 W without option, 8 W max.

## ► Accuracy

	C.A 2150-E	C.A 2150-M		C.A 2150-D		
		Process/load/Ω	Temperature	Freq. / Tacho.	Meter	
Max. error on reading	Vac: ±0.30% Iac: ±0.30% Vdc: ±0.05% Idc: ±0.10%	±0.1% + 1 digit	TC	±0.4% R ± 0.6°C	0.005% R	0.01% R
			Pt100	±0.2% ± 0.6°C		
Resolution	2 V rating: 0.1 mV 20 mV rating: 1 mV 200 V rating: 10 mV 600 V rating: 0.1 V 200 mA rating: 0.01 mA 1 / 5 A rating: 0.1 mA 50/60 / 100 mV rating: 0.01 mV	Process: voltage 1 mV / current 1 µA Load cell: 1 µV Temperature: 0.1° / 1° (selectable)		Frequency: 0.01 Hz Chronometer: 0.01 s		
		Temperature coefficient	100 ppm/°C	100 ppm/°C	50 ppm/°C	
Warm-up time	15 minutes	10 minutes		5 minutes		

## ► Special functions

- Reset to factory configuration
- Change of display colour
- Total or partial locking of programming by code
- Display with 2 levels of brightness

## ► Standards

Insulation – dielectric strength: EN 611010-1 (Category II installation)

EMC - Immunity: EN 61000-4-2 EN 61000-4-3, EN 61000-4-4, EN 61000-4-5, EN 61000-4-6 and EN 61000-4-11

EMC - emission: EN 55022

## ► Dimensions (in mm)

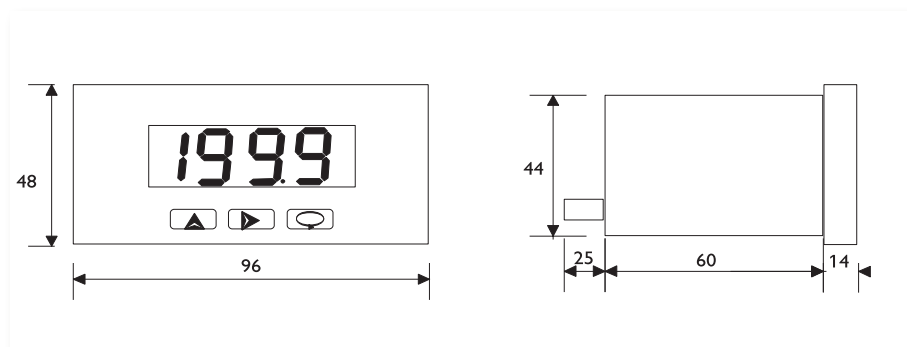

## ► Panel drilling specifications (in mm)

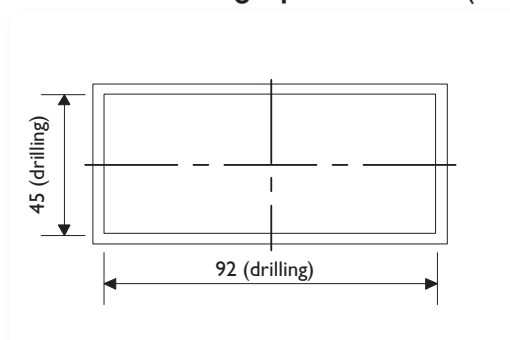

## ► Associated products

Current transformers  
and shunts

► page 102



Tachometer  
sensor

► Contact us



Thermocouple / probe

► Pyrocontrol Catalogue



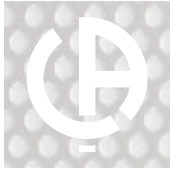

# C.A 2200 Range

48 x 96 mm programmable digital panel meters for universal use

Digital panel meters

Measurement and instrumentation

## PRODUCT ADVANTAGES

- +** **RECORDING**  
of maximum and minimum values of input variable
- +** **SERIAL LINK**  
for remote processing of measurements
- +** **LINEARIZATION**  
of input signal over 11 segments



Simple programming using 5 keys on front panel



Accessories for surface or DIN rail mounting

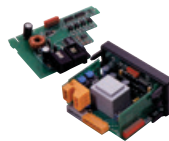

Very simple installation of option boards



Quick connection using plug-in connectors

## Description

On the 4 instruments, two digital filters can be activated to stabilize the display of measurements depending on the processing conditions.

The measurement display can be disabled remotely by closing a contact. The display and reset of MAX and MIN values can also be activated remotely.

On the **C.A 2200-P** and **C.A 2200-C**, activation and cancellation of the OFFSET function can also be controlled remotely. The OFFSET command functions may be modified by the user, with 26 functions in all being pre-programmed on the instruments.

On the **C.A 2200-P** and **C.A 2200-C** models, the display can also be set to flashing mode to indicate an alarm threshold overrun.

## Option boards\*

Model	Reference
C.A 2XXX AL 2-relay board	P01 3193 01
C.A 2XXX AL 4-relay board	P01 3193 03
C.A 2XXX 4 NPN board	P01 3193 04
C.A 2200 analogue output board	P01 3193 05
C.A 2200 BCD output board	P01 3193 08
C.A 2XXX COM RS232 board	P01 3193 06
C.A 2XXX COM RS485 board	P01 3193 07

\* Extra boards (addition or replacement)

## Accessories

Model	Reference
Multi-position fitting with 2 DIN rail adapters	P01 3194 01
Rear fitting with 2 DIN rail adapters	P01 3194 02
Connector + 1 m RS232 cable	P01 3194 03
Connector + 1 m RS485 cable	P01 3194 04
Kit of 4 x C.A 2200 screw connectors	P01 3194 06



## C.A 2200-P

Process signal U/I DC

- **Voltage:** 0 to  $\pm 10$  V with 1 M $\Omega$
- **Current:** 0 to  $\pm 20$  mA with 15  $\Omega$
- **Potentiometer:** 200  $\Omega$  to 100 k $\Omega$

## C.A 2200-T

Temperature

- tc J: -50 to 850°C / -58 to 1,562°F
- tc K: -50 to 1,200°C / -58 to 2,192°F
- tc T: -200 to 400°C / -328 to 752°F
- tc R: 0 to 1,700°C / -32 to 3,092°F
- tc S: 0 to 1,700°C / -32 to 3,092°F
- tc E: -50 to 1,000°C / -58 to 1,892°F
- Pt 100: -100 to 800°C / -148 to 1,472°F

## C.A 2200-C

Load cell

- 0 to  $\pm 15$  mVdc with 100 M $\Omega$
- 0 to  $\pm 30$  mVdc with 100 M $\Omega$
- 0 to  $\pm 60$  mVdc with 100 M $\Omega$
- 0 to  $\pm 300$  mVdc with 100 M $\Omega$

## C.A 2200-D

Frequency meter / Tachometer  
Counter / Chronometer

- **Magnetic sensor:**  $V_{in} > 120$  mVrms
- **NAMUR sensor:**  
 $I_{on} < 1$  mAdc /  $I_{off} > 3$  mAdc /  $R_c = 1$  k $\Omega$
- **TTL/24V encoder or NPN/PNP sensor:**  
"1"  $> 1.6$  Vdc / "0"  $< 1.5$  Vdc
- **Dry contact:**  $V_c = 5$  V /  $R_c = 3.9$  k $\Omega$  /  $F_c = 100$  Hz
- **Voltage:** 10 to 650 Vac (Fmin 0.1 Hz / Fmax 2 kHz)

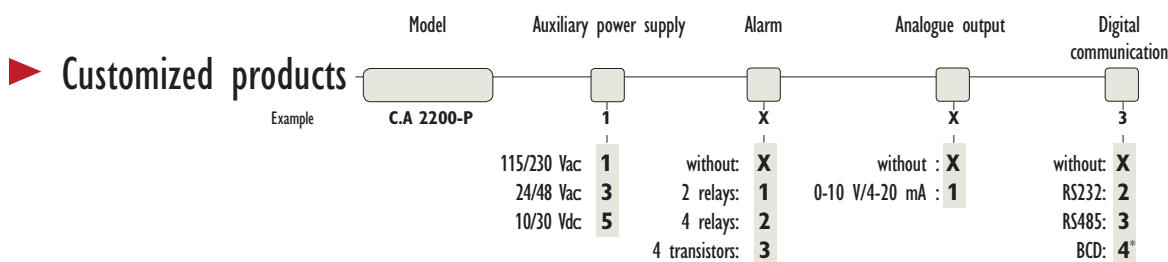

\* Choice of the BCD output cancels the alarm and analogue outputs



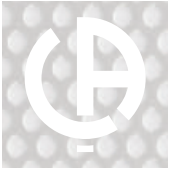

# C.A 2200 Range

Programmable digital panel meters in 48 x 96 format for universal use

Digital panel meters

Measurement and instrumentation

## ► Display

	C.A 2200-P	C.A 2200-C	C.A 2200-T	C.A 2200-D
Display resolution	65,000 counts			
Display range	±32,000	±32,000	±32,000	Counter: ±32,000 Tachometer: 0...99,999 Chronometer: 0.00 s to 9,999.9 h Frequency meter: 0 to 25,000
Display indicators	Red LED 7 segments, Height 14 mm			
Reading	5 digits			
Polarity	automatic			
Overrun	OVE displayed			
Decimal position	Programmable by software			
Display blocking	MAX/MIN function			
Measurement rate	16 measurements / second			
Response time	62 ms (250, 425, or 775 ms depending on filter programmed)			

## ► Function

	C.A 2200-P	C.A 2200-C	C.A 2200-T	C.A 2200-D
OFFSET function	on keyboard	on keyboard	by programming	on keyboard
Remote control (4 logical inputs)	26 pre-programmed functions		18 pre-programmed functions	Display blocking: MIN/MAX/RESET and clear MIN/MAX/RESET display

## ► Sensor excitation

	C.A 2200-P	C.A 2200-C	C.A 2200-T	C.A 2200-D
Sensor excitation	120 mA at 5 or 10 V or 30 mA at 24 V	120 mA at 5 or 10 V	-	8 V or 24 Vdc / 30 mA

## ► Accuracy

	C.A 2200-P	C.A 2200-C	C.A 2200-T	C.A 2200-D
Measurements	0.15 µA or 0.3 µA	0.01% R ±2 counts	0.1°C or 1°C	0.01% R ±1 count
Temperature coefficient	50 ppm/°C	100 ppm/°C	100 ppm/°C	50 ppm/°C

## ► Mechanical specifications

Material	Polycarbonate V0 as per UL
Weight	475 g (without option)
	850 g (with options)
Protection rating	IP 65 on front panel
Fitting	On panel using self-locking strap

## ► Environment

Operating temperature	0 to +50°C
Storage temperature	-25 to +85°C
Relative humidity	< 95% at +40°C

## ► Power supply

AC voltage	bivoltage 115/230 Vac $\pm 15\%$ 50/60 Hz
	bivoltage 24/48 Vac $\pm 15\%$ 50/60 Hz
Consumption	5 VA without option, 10 VA max
DC voltage	10 to 30 Vdc
Consumption	5 W without option, 10 W max

## ► Standards

Low voltage directive 73/23/EEC  
Insulation - dielectric strength IEC 61010-1

## ► Dimensions (in mm)

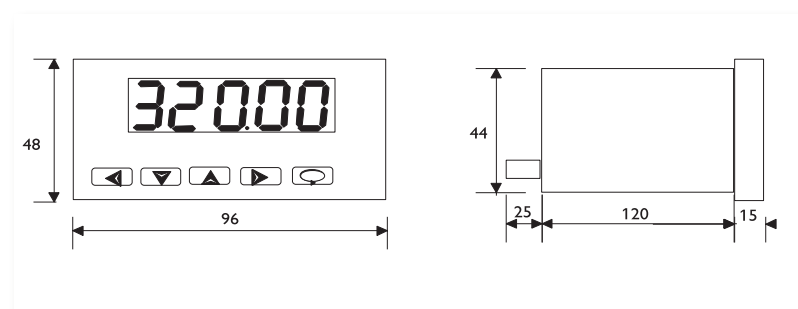

## ► Panel drilling specifications (in mm)

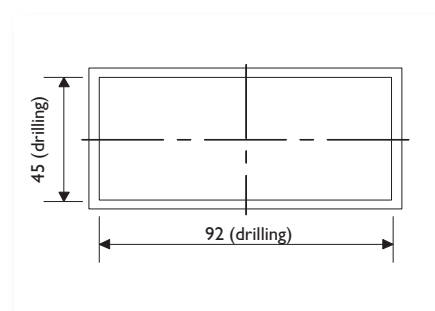

## ► Associated products

Current transformers  
and shunts

► page 102



Tachometer  
sensor

► Contact us



Thermocouple / probe

► Pyrocontrole Catalogue



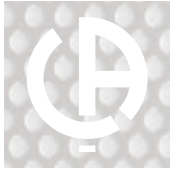

# ENERTRACE Range

“Plug & Play” paperless recorder

Graphic recorder

Measurement and instrumentation

## PRODUCT ADVANTAGES

- +** VERY-HIGH-RESOLUTION TFT VGA SCREEN, 6.4”, 256 colours
- +** Up to 18 CONFIGURABLE MEASUREMENT CHANNELS
- +** Data backup on Compact Flash card (up to 1 GB)
- +** ETHERNET link and PROCESSING SOFTWARE provided as standard



512 MB memory card as standard



6 slots for 3 types of input/output cards (logical, relay, analogue)



Portable version available

## ► Description

**ENERTRACE** is a “plug & play” paperless recorder suitable for all types of processes. It is equipped with an 18-bit converter for optimum measurement accuracy and a polling rate of 200 ms per channel.

- Inputs / outputs which can be configured and extended: up to 18 analogue measurement channels (mV,V,mA,T°,etc.) or 12 isolated and configurable logical inputs and up to 12 relay outputs, depending on the combinations.
- Computer processing of the data via a PC link
- Remote adjustment and configuration via an RS232, RS485 or Ethernet link
- Recording of data over a period of several months
- Simplified maintenance due to the absence of parts subject to wear or requiring replacement (paper, pens, etc.)
- Auxiliary power supply with broad dynamic range: 90 to 264 Vac / 11 to 370 Vdc

## ► Display



**Bargraph mode**  
Vertical display of 6 bargraphs.  
Configurable scale for each bargraph.  
Bars identified by colour and process label. High and low alarms marked “Hi/Lo”.

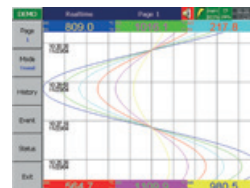

**Graphic curves mode**  
Vertical or horizontal display of 6 curves in real time  
Simple switching from one page to another using the “Page” function  
Constant display of the date and time, as well as a pictogram if there is an alarm or the memory is full.



**Log of alarms**  
Display of all time / date-stamped alarms.  
“Browse” function for choosing the alarms to be cleared.  
Different colours for different alarm statuses.

## ► Electrical specifications

### Auxiliary power supply

Alternating current, operating domain and consumption:  
90... 264 Vac, 47...63 Hz, 60 VA, 30 W max.

Direct current, operating domain and consumption:  
11...370 Vdc, 60 VA, 30 W max.

### Analogue input board

Channels: 3 per card

Resolution: 18 bits

Polling rate: 200 ms

Maximum value: -2 Vdc min., 12 Vdc max. (for standard board)

Temperature drift:

$\pm 1.5 \mu\text{V}/^\circ\text{C}$  - except for mA inputs;  $\pm 3.0 \mu\text{V}/^\circ\text{C}$  for mA inputs

Influence of line resistance:

TC:  $0.2 \mu\text{V}/\Omega$  and 3-wire Pt100:  $2.6^\circ\text{C}/\Omega$ . of difference between 2 branches

Sensor break-induced current: 200 nA

Common-mode rejection: 120 dB

Serial-mode rejection: 55 dB

Insulation voltage between channels: 430 Vac

Sensor failure detection: sensor open-circuit for TC, Pt100 and mV inputs

- below 1 mA for the 4-20 mA input

- below 1 mA for the 4-20 mA input

- not applicable to the other inputs

Response time after sensor failure:

0.1 sec for 4-20 mA and 1.5 V and 10 sec for CT, Pt100 and mV

Type	Scale	Accuracy at 25°C	Impedance
<b>Analogue input board, negative U/I</b>			
-20 +20 mA	-22 ... +22 mA	$\pm 0.1\%$	70.5 $\Omega$
-60 +60 mVdc	-62 ... +62 mVdc	$\pm 0.1\%$	2.2 M $\Omega$
-2 + 2 Vdc	-2.2 ... +2.2 Vdc	$\pm 0.1\%$	332 k $\Omega$
20 +20 Vdc	-22 ... +22 Vdc	$\pm 0.1\%$	332 k $\Omega$

### Standard analogue input board

mV	-8 ... 70 mV	$\pm 0.05\%$	2.2 M $\Omega$
mA	-3 ... 27 mA	$\pm 0.05\%$	70.5 $\Omega$
V	-0.12 ... 1.15 V	$\pm 0.05\%$	332 k $\Omega$
0/5 V	-1.3 ... 11.5 V	$\pm 0.05\%$	332 k $\Omega$
1/5 V	-1.3 ... 11.5 V	$\pm 0.05\%$	332 k $\Omega$
0/10 V	-1.3 ... 11.5 V	$\pm 0.05\%$	332 k $\Omega$
J*	120 ... 1,000°C	$\pm 1^\circ\text{C}$	2.2 M $\Omega$
K*	-200 ... 1,370°C	$\pm 1^\circ\text{C}$	2.2 M $\Omega$
Pt100 (DIN)*	-210 ... 700°C	$\pm 0.4^\circ\text{C}$	1.3 k $\Omega$

\* Other types of temperature probes: please contact us

### Logical input boards

Channels: 6 per board

Low level: -5 V minimum, 0.8 V max.

High level: 2 V minimum, 5 V max.

External pull-down resistance: 1  $\Omega$  max.

External pull-up resistance: 1.5 M $\Omega$  min.

### Relay output boards

Relays: 6 per boards

Contact type: N.O (normally open)

Relay type: 5 A/240 Vac

Number of cycles: 200,000 resistive load

### Analogue current output boards

Measurement input transcription card with function for possible multiplication, addition or subtraction of inputs

Type: 0-20 mA and 4-20 mA

## ► Communication

### Serial communication module

Interface	RS232 - RS422 or RS485
Protocol	ModBus RTU
Address	1 to 247
Speed	0.3 to 38.4 kbits/s
Data bits	7 or 8 bits
Parity bit	none, even or odd
Stop bit	1 or 2 bits

### ETHERNET communication module

Protocol	ModBus TCP/IP, 10BaseT with automatic polarity correction
Ports	AUI and RJ-45 with auto-detection capability

## ► Environment

Operating temperature	+5°C to +50°C
Storage temperature	-25°C to +60°C
Relative humidity	20 to 80% RH
Insulation resistance	20 M $\Omega$ min. (at 500 Vdc)
Dielectric strength	3 kVac at 50/60 Hz for 1 minute
Vibration resistance	10-55 Hz, 10 m/s <sup>2</sup> for 2 hours
Shock resistance	3 m/s <sup>2</sup> (3 g) in operation, 100 g during transport
Infrared sensor	detection of human presence up to 2 m away (screen saver)
Weight	1.9 kg

## ► Standards

Safety	UL873 (11 <sup>th</sup> edition 1994) CSA: C22.2 N° 24-93 CE: EN61010-1 (IEC 1010-1) Overvoltage category II, pollution degree 2
Protection class for indoor use	Cabinet front panel IP30, wiring IP20
EMC emission	EN50081-2. EN61326 (EN55011 class B. EN61000-3-2. EN61000-3-3)
Immunity	EN50082-2. EN61326 (EN61000-4-2. EN61000-4-3. EN61000-4-4. EN61000-4-5. EN61000-4-6. EN61000-4-11. EN50204)

## ► Configuration software

TracerManager 1: configuration and retrieval of historical data on PC

TracerManager 2: configuration, retrieval and display of real-time data on PC

Minimum configuration required: PC 200 MHz - 64 MB RAM

## ► Internal memory: 8 MB

Compact Flash extension up to 4 GB



# ENERTRACE Range

“Plug & Play” paperless recorder

Graphic recorder  
Measurement and instrumentation

## ► Electrical connections

### Analogue inputs

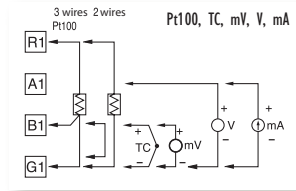

### Logical inputs

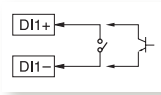

### Analogue outputs

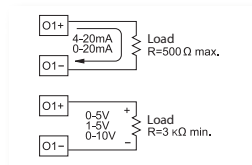

### Relay outputs

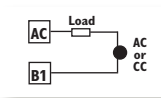

## ► Dimensions

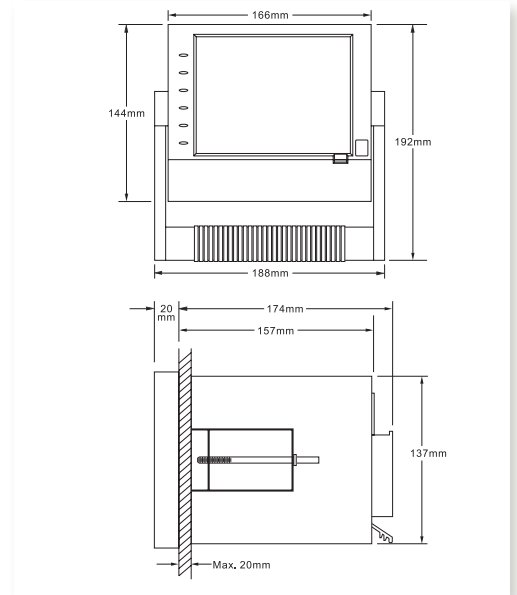

## ► Panel cut-outs

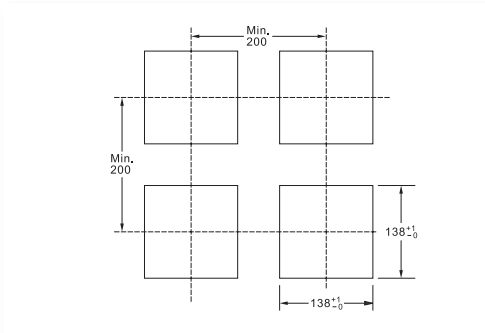

## ► Associated products

Transducers

► page 152



CT Current transformers

► page 102



## TO ORDER

## ENERTRACE



<b>1 Power supply</b>	<b>Code</b>
4 90-264 Vac 47-63 Hz /110-370 Vdc	————— standard
6 11-18 Vdc	
7 18-36 Vdc	
8 36-72 Vdc	
<b>2 Analogue inputs</b>	————— <b>LR00112-000*</b>
0 no analogue input 0 slot	
3 3 analogue inputs 1 slot	
6 6 analogue inputs 2 slots	
A 9 analogue inputs 3 slot	
B 12 analogue inputs 4 slots	
C 15 analogue inputs 5 slots	
D 18 analogue inputs 6 slots	
<b>3 Logical inputs</b>	————— <b>LR00113-000*</b>
0 no logical input 0 slot	
1 6 logical inputs 1 slot	
2 12 logical inputs 2 slots	
<b>4 Relay outputs</b>	————— <b>LR00114-000*</b>
0 no relay 0 slot	
1 6 relays 1 slot	
2 12 relays 2 slots	
<b>5 Communication</b>	————— standard
0 via Ethernet	
1 RS232/422/485 (3 in 1) + Ethernet interface	
<b>6 Configuration software</b>	————— standard
1 "TracerManager1"	
<b>7 ENERTRACE software</b>	
0 basic version	
1 calculation, counter and totalizer functions	
<b>8 Compact Flash</b>	————— standard
1 1 GB	
<b>9 ENERTRACE mounting</b>	————— standard
1 version for cabinet mounting	
2 portable version with carrying handle	
<b>10 Option</b>	
0 no option	
1 24 Vdc power supply for transmitters (6 max.) [1 slot]	————— <b>LR00115-000*</b>
<b>11 Analogue outputs</b>	————— <b>LR00123-000*</b>
0 no analogue output 0 slot	
3 3 analogue mA outputs 1 slot	
6 6 analogue mA outputs 2 slots	
A 9 analogue mA outputs 3 slots	
<b>12 Negative U/I analogue inputs</b>	————— <b>LR00128-000*</b>
0 no negative U/I input 0 slot	
3 3 negative U/I inputs 1 slot	
6 6 negative U/I inputs 2 slots	
A 9 negative U/I inputs 3 slots	
B 12 negative U/I inputs 4 slots	
C 15 negative U/I inputs 5 slots	
D 18 negative U/I inputs 6 slots	

## ACCESSORIES:

"TracerManager2" software	————— <b>LR00132-000*</b>
4 GB Compact Flash memory	————— <b>LR00121-000*</b>
Flash/USB adapter	————— <b>LR00127-000*</b>

\*Can be sold separately





# SYNCHROCOUPLER Range

Synchronization instruments for LV networks

Synchronization instruments  
Measurement and instrumentation

## PRODUCT ADVANTAGES

- +** INTEGRATED IN A 96 X 96 FORMAT
- +** 1 synchronization command
- +** 1 control command
- +** 3 command modes for synchronization
- +** Adjustment in just a few seconds (PID model)

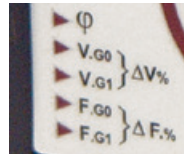

Display of deviations between setpoint and measurement

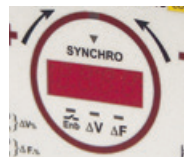

LED display of 3 measurements: phase, frequency and voltage



User-programmable

## ► Description

The **SYNCHROCOUPLER** is an automatic synchronization instrument for generator sets. It includes:

- a control relay for assisted manual coupling or automatic coupling with time delay control
- two control relays (fast/slow) for speed adjustment
- an external control loop for opening the coupling relay
- four front panel keys for programming, display and messages (password option included)

## SYNCHROCOUPLER



### Display:

- Phase angle variations by 30 LEDs arranged in a circle
- Voltages, frequencies, variations (in %) on 4 digits
- Frequency variations  $\pm$ , status of coupler relay, conditions obtained in phase, frequency and voltage

Power Supply	Reference
24 VDC	LS9N 421X
48 VDC	LS9N 422X
110 VAC	LS9N 423X
230 VAC	LS9N 424X
400 VAC	LS9N 425X

## SYNCHROCOUPLER PID



### Display: as for synchrocoupler

**PID adjustment method** (Proportional Integral Derivative) for synchronization that is faster and more accurate than with conventional synchronous couplers

- **Proportional:** proportional correction of measurement errors
- **Integral:** guarantees reduction of adjustment error to 0
- **Derivative:** brings greater stability to the system, enabling you to anticipate the inertia of generator sets (e.g. hydroelectric)

Power Supply	Reference
24 VDC	LS9N 441X
48 VDC	LS9N 442X
110 VAC	LS9N 443X
230 VAC	LS9N 444X
400 VAC	LS9N 445X



# SYNCHROCOUPLER Range

Synchronization instruments for LV networks

## ► Electrical specifications

Measurements	
Rated voltage range	110 to 600 V
Frequency	35 Hz...80 Hz
Permanent overvoltage	800 V
Consumption	< 500 $\mu$ A
Relay output	
With sealed inverter contact	8 A - 250 Vac / 5 A - 30 Vdc
Multi-measurement (accuracy)	
Phase angle deviation	$\pm 0.5^\circ$
Frequency	$\pm 0.01$ Hz
Voltage (RMS)	Class 1 $\pm 2$ digits
Auxiliary power supply	
AC voltage	-10% / +15%
Frequency	35 Hz...450 Hz
Consumption	10 VA

## ► Environment

Operating temperature	-10°C to +65°C
Storage temperature	-40°C to +70°C
Relative humidity	< 90% at 40°C
Protection rating	3
Pollution level	2

## ► Mechanical specifications

Casing materials	
Casing and flange	Self-extinguishing black ABS
Front panel	Light grey polycarbonate
Protection rating	IP 54 front panel (IP 65 optional)
Weight	350 g
Connection	Holder for 2.5 mm wire
Fitting	Mounting on 8 mm front panel

## ► Standards

Reference standards	
Safety	IEC 61010-1
Dimensions	DIN 43700
EMC	EN 61326-1
ANSI function	Nos. 25 and 90
Resistance to shock	IEC 60068-2-27
Resistance to vibrations	IEC 60068-2-6
Environment	IEC 60068-1

► Electrical connections

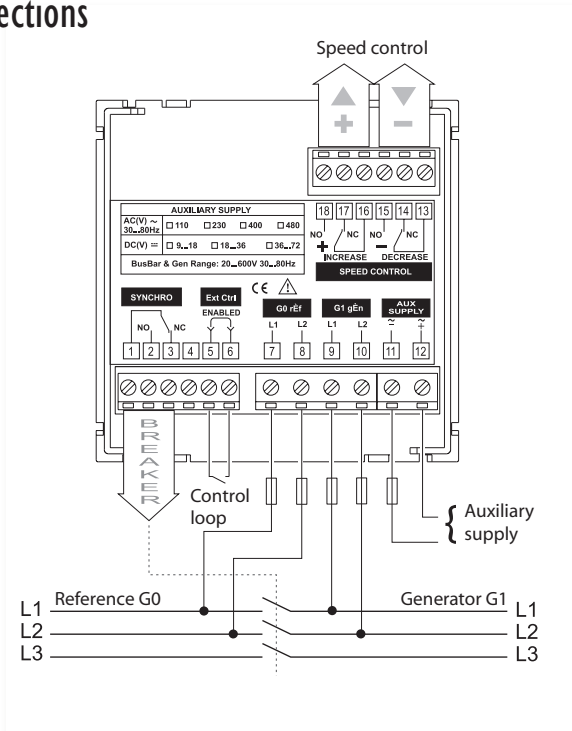

► Dimensions and drilling specifications (mm)

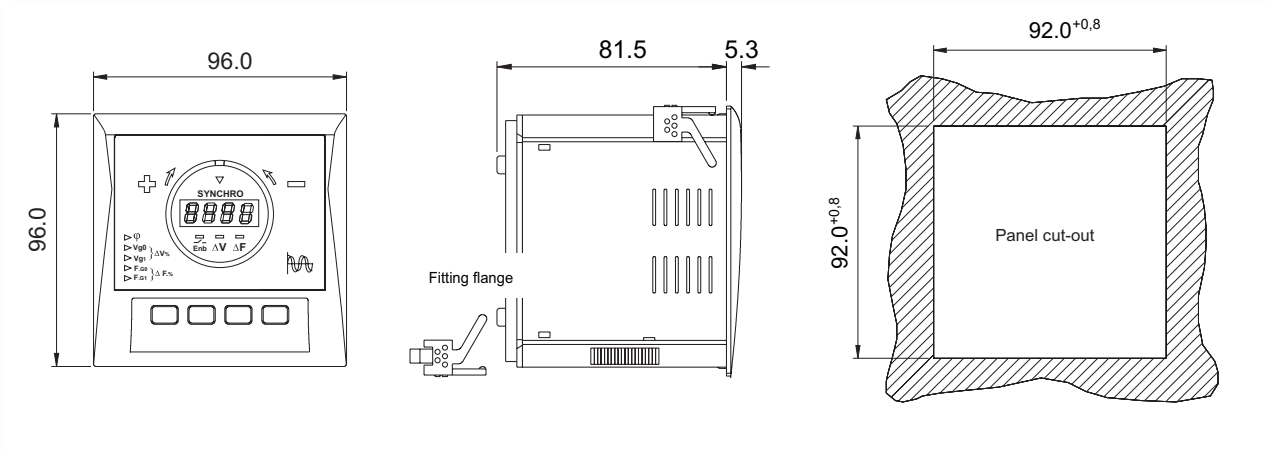



# Analogue panel meters

► Measurement and instrumentation

## Normeurope range

Normeurope range  
► page 222



AC ammeter  
► page 226



AC voltmeter  
► page 226



Frequency meter  
► page 227



Maximum demand ammeter  
► page 228



Wattmeter  
Varmeter  
► page 229



Phasemeter  
► page 230



Synchronization equipment  
► page 231



DC ammeter  
► page 232



DC voltmeter  
► page 233



Command function meter  
► page 234



## COHO/LK ranges



COHO hour meters  
► page 236



LK hour meters  
► page 237



# Choosing an analogue panel meter

<b>NORMEUROPE</b>	<b>COHO / LK</b>
▶ page 222	▶ pages 236/237
	

Front panel drilling						
Round barrel					COHO	LK
Square barrel						LK
Front panel						
Format	48 x 48	72 x 72	96 x 96	144 x 144	48 x 48	48 x 48
Standard functions						
AC Ammeter	90°		250°			
AC Voltmeter	90°		250°			
Pointer dial frequency meter	90°		250°			
Vibrating reed frequency meter	1 x 9 reeds					
Maximum demand ammeter	90°					
Wattmeter / Varmeter	90°		250°			
Phasemeter	90°		250° 360°			
DC Ammeter	90°		250°			
DC Voltmeter	90°		250°			
Hour meter						
Synchronization equipment						
Synchronoscope	360°					
Double vibrating reed frequency meter	2 x 9 reeds					
Differential voltmeter	90°		250°			
Command functions meter						
AC Current / AC Voltage	90°					
DC Current / DC Voltage	90°					
Temperature	90°					
<b>Strengths</b>	NORMEUROPE, the industry reference for the production, transportation and distribution of electrical energy for high-level operating constraints.				COHO, the industry reference for high limit operating environments and LK for standard applications.	





# Info & advice

## Analogue panel meters

### Measurement and instrumentation

The essential function of the analogue panel meter is to display instantaneous and variable values. It shows the pointer's position and movement, both required for monitoring industrial processes.

### SELECTING A PANEL METER

As a panel meter is a low-cost item, it is easily installed at the various command and monitoring points: the switchboard panels of LV distribution networks, motor drive control units or automation device panels.

#### Functions

Choose the quantity to be displayed in order to monitor and control a known risk. For an electrical line, for example, the voltage is selected as it is crucial for ensuring user safety.

#### Ergonomics

Choose the instrument size depending on the distance between the operator and the mounting panel. Choose the pointer deflection: a deflection of 240° may be preferred to the usual 90° deflection, to facilitate the reading of extended ranges.

#### Environmental constraints and standards

It is important to take into account mechanical specifications, environmental restrictions, standards in force, consumption and compatibility with sensors, in order to choose the appropriate dial ranges and calibration scales.

#### Options and accessories

Panel meters, though robust by nature, are nevertheless sensitive to degraded environments. It is therefore recommended to choose customized solutions for military applications, for onboard rail applications or for explosive atmospheres.



### MOVING IRON OR MOVING COIL?

The electric current is read directly by a sensor guiding the pointer movement. The two most usual types are:

#### Moving iron

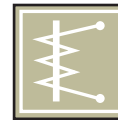

The moving iron panel meter is composed of a fixed magnet and a mobile magnet, mutually repellant and placed in the field of a coil powered by the current to be measured. The moving iron panel meter carries out measurements in true RMS.

Calibrated for alternating current, it can also measure values in direct current but with a diminished accuracy rating of about 3. The scale can be normal, motor or expanded.

#### Moving coil



The moving coil panel meter is composed of a coil traversed by the current to be measured which pivots around a permanently fixed magnet. Due to its low consumption, the moving coil panel meter is the ideal instrument for the measurement of low direct current values. Its scale is linear.



## SPECIAL FUNCTIONS

### Maximum demand ammeters

The maximum demand ammeter or thermal ammeter indicates the RMS current for a given period. It is designed to control slow overloads on transformers, cables, etc.

### Synchronization equipment

Necessary for the paralleling of generators or network-network or network-alternator coupling. The user can thus ensure that the voltage to be synchronized and the reference voltage are of the same frequency and amplitude and are in phase before carrying out the coupling.

The **synchronoscope**, used to synchronize 2 different sources, indicates the moment when their phaseshifting and frequencies are identical. The pointer indicates the central position and remains stationary.

The **vibrating-reed dual frequency meter** enables you to synchronize the frequency of a source with a reference source.

The **double voltmeter**, composed of two independent moving iron measuring elements, is used to synchronize the voltages of two different sources, and indicates the voltage present on each. The **differential or zero voltmeter** is powered by the voltages of two different sources and indicates the percentage difference between the source to be synchronized and the nominal voltage.

The **phase rotation sequence indicator** enables you to verify that the phase rotation sequence of a three-phase system is respected.

## FOCUS

### How to connect a panel meter

The analogue panel meter is easy to mount and connect. The dial contains an array of pictograms and terminals indicating polarity markers. A user guide is supplied only for complex functions.

The precautions to be taken concern:

- the cross-section of connecting wires and their lugs;
- the mounting or replacement of dials when they are interchangeable;
- heat loss, if the panel meters are enclosed in very small volumes.

### Maintenance of your panel meter

Check regularly that the connection terminals of the panel meter are tightened correctly when a strong current is passed through it.

Clean regularly to avoid the accumulation of static electricity on the plastic transparent surface of the dial (cleaning with soapy water is sufficient).

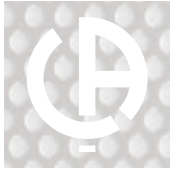

# NORMEUROPE Range

Round barrel analogue panel meters for high-level operating constraints

Analogue panel meters  
Measurement and instrumentation

## PRODUCT ADVANTAGES

- +** **WIDE CLIENT REFERENCE BASE:**  
main utilities, marine applications, energy producers and distributors
- +** **WIDE CHOICE**  
of functions, formats, ratings and options
- +** **LONG PRODUCT LIFE SPAN**



Accurate



Slim-line, small barrel diameter, multiple connection possibilities



Attractive design and easy to read

## ► General specifications

**Standard:** IEC 60051-1

**Accuracy:** class 1.5  
( $\pm 1.5\%$  error margin at full scale)

**Front panel protection:** IEC 60529  
(see presentation table)

**Insulation test:**  
IEC 61010-1 Category III

**Maximum service voltage:** 650 Vac

**Mechanical shock resistance:**  
IEC 68-2-27

**Vibration resistance:** IEC 60068-2-6

**Environment:** IEC 68-1

Reference temperature:  $23^{\circ}\text{C} \pm 2^{\circ}\text{C}$   
Operating temperature:  $-25^{\circ}\text{C}$  to  $+50^{\circ}\text{C}$   
Storage temperature:  $-25^{\circ}\text{C}$  to  $+70^{\circ}\text{C}$   
Relative humidity:  $< 90\%$  at  $40^{\circ}\text{C}$

**Mounting:**

- Front panel mounting
- Panel thickness: 8 mm max.

**Materials:**

Barrel: self-extinguishing polycarbonate  
Front panel: polymethyl methacrylate  
(glass option NEL)

Additional terminal: socket in Bakelite,  
cover in ABS

Dial: light alloy, black markers on white  
background

Black knife-edge arrow pointer

**Operating position:**  
calibrated for vertical position ( $\pm 10\%$ )

**Overloads:**

- Voltmeter and frequency meter
- 1.2  $U_n$  permanent
- 2  $U_n$  during 5 secs
- Ammeter
- 1.3  $I_n$  permanent
- 10  $I_n$  during 5 secs

**Extreme values:**

Safety recommendation IEC 60 051-1  
1-1.2 - 1.5 - 2 - 2.5 - 3 - 4 - 5 - 6 - 7.5 - 8  
- 9 and their multiples and decimal  
sub-multiples

## ► Dimensions and panel drilling specifications

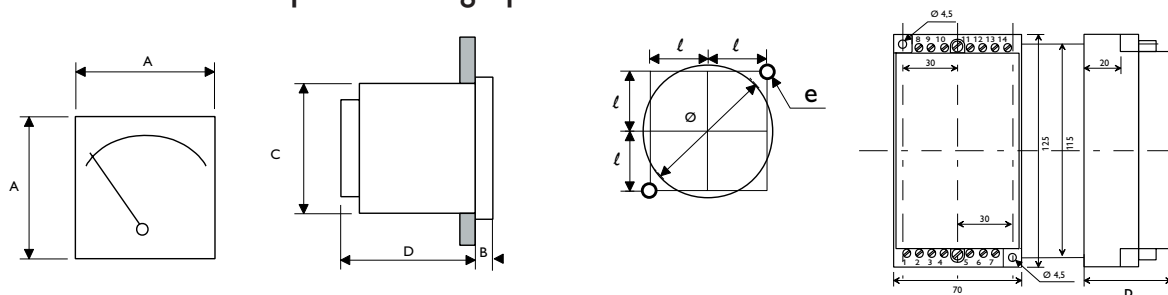

A x A Format	Panel meter				Additional unit	
	48 x 48	72 x 72	96 x 96	144 x 144	A	B
B (mm)	8	13	14	20		
C (mm)	diam. 44	diam. 55	diam. 80	diam. 80		
D 90° deflection (mm)	46	29 if 20 A max, 39 if 25 A max or more		24.5		
D 250° deflection or blades (mm)	58	71		66		
D 360° deflection (mm)			128 phasem. 108 synchro	131 phasem. 104 synchro		
D command unit (mm)			93			
Ø (mm)	45	58	88	138		
ℓ (mm)	20.25	26.5	34	55		
e or p (mm)	3.5	4.5	4.5	5.5	48	122
Weight (kg)	0.20	0.25	0.30	0.45	0.30	0.70
Terminal	M4 and Faston up to 20 A, M6 for higher values				cage for 4 mm <sup>2</sup> wire	

## ► Mechanical specifications

Deflection	90°				250°			
	48 x 48	72 x 72	96 x 96	144 x 144	48 x 48	72 x 72	96 x 96	144 x 144
<b>Panel mounting and tightness</b>								
Protection: front panel IP 40; unit IP 20 360° panel meters all with 4 studs	2 studs M2.5	2 studs M4	2 studs M4	2 studs M5	2 studs M2.5	2 studs M4	2 studs M4	2 studs M5
Option Ring fastener IP 40 front panel	48 mm drill	58 mm drill	88 mm drill		48 mm drill	58 mm drill	88 mm drill	
Option Sealed gasket IP 52 front panel	2 studs M2.5	2 studs M4	2 studs M4	2 studs M5	2 studs M2.5	2 studs M4	2 studs M4	2 studs M5
Option Reinforced mounting+gasket IP 52 front panel	4 studs M2.5	4 studs M4	4 studs M4	4 studs M5	4 studs M2.5	4 studs M4	4 studs M4	4 studs M5
Option Watertight (except lmax) IP 54 front panel		4 studs M4	4 studs M4	4 studs M5	4 studs M2.5	4 studs M4	4 studs M4	4 studs M5
Option Marine (except lmax) IP 55 full unit		4 studs M4	4 studs M4	4 studs M5	4 studs M2.5	4 studs M4	4 studs M4	4 studs M5
<b>Non-standard front cover</b>								
NEL (in glass with black surround)		•	•			•	•	
NEL non-reflecting glass (matt surface with black surround)		•	•	•		•	•	•
<b>Dial non-standard options</b>								
Creation of dial markings (where feasible)	•	•	•	•	•	•	•	•
Colour marking	•	•	•	•	•	•	•	•
Colour zone	•	•	•	•	•	•	•	•
Black background, white markings	•	•	•	•	•	•	•	•
Markings not in standard documentation	•	•	•	•	•	•	•	•
Double scale		•	•	•	•	•	•	•

## ► Accessories

Deflection	90°				250°			
	48 x 48	72 x 72	96 x 96	144 x 144	48 x 48	72 x 72	96 x 96	144 x 144
Front panel sealed gasket	2465 001	2314 375	2314 376	2465 004	2465 001	2314 375	2314 376	2465 004
Fitting clip (without seal)	2328 558	2302 348	2307 086		2328 558	2302 348	2307 086	
Standard dial	•	•	•	•	•	•	•	•
Customized dial	•	•	•	•	•	•	•	•
Antistatic liquid	9030 00676							
Insulation sleeve for terminals	ACQ 1001							

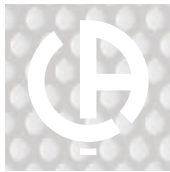

# NORMEUROPE Range

Analogue panel meters

Measurement and instrumentation

## AC Ammeter



### ■ Deflection

**Standard scale model**

**Accuracy class:** 1.5

**Measuring component:** moving iron  
50-60-400 Hz and rectified moving coil  
50-10,000 Hz

Pseudo linear scale (moving iron)  
Interchangeable dial, except 144 x 144

**Consumption:** 1 VA

**Motor scale model**

**Accuracy class:** 1.5

**Measuring component:** moving iron  
50-60-400 Hz  
Pseudo linear scale

Calibrated 0-In up to 2/3 of deflection, beyond overload zone  
Interchangeable 90° dial, except 144 x 144 format

**Consumption:** 1 VA

### ■ Deflection

**Standard scale model**

**Accuracy class:** 1.5

**Measuring component:** rectified moving coil 50-10,000 Hz  
Linear scale

With additional unit "A" in 48 x 48 format

**Consumption:** 0.5 VA

**Motor scale model**

**Accuracy class:** 1.5

**Measuring component:** rectified moving coil 50-10,000 Hz  
Linear scale

Calibrated 0-In up to 2/3 of deflection, beyond overload zone  
With additional unit "A" in 48 x 48 format

**Consumption:** 0.5 VA

## ► Feasibility limits

Deflection									
Format		48 x 48	72 x 72	96 x 96	144 x 144	48 x 48	72 x 72	96 x 96	144 x 144
<b>Direct connection</b>									
Standard scale	moving iron	0.5 to 15 A		0.5 to 50 A					
	moving coil			1 mA to 25 A		1 mA to 25 A			
Motor scale	moving iron 2 to 6 In	0.5 to 12 A		0.5 to 40 A					
	moving coil 2/3/5 In					0.5 to 20 A			
<b>Connection on CT</b>									
Standard scale	moving iron			1 to 6.6 A					
	moving coil			1.3 to 6.6 A		1.2 to 6.6 A			
Motor scale	moving iron 2 to 6 In			1 A and 5 A					
	moving coil 2/3/5 In					1 A and 5 A			

## ► Direct connection

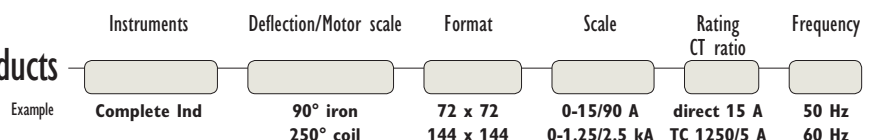

Deflection		Moving iron. 50 Hz							
Format		48 x 48	72 x 72	96 x 96	144 x 144	48 x 48	72 x 72	96 x 96	144 x 144
<b>Rating</b>	<b>Scale In</b>								
5 A	0-5 A	•	A90A 0302	A90A 0502	•	•	•	•	•
10 A	0-10 A	•	A90A 0303	A90A 0503	•	•	•	•	•
20 A	0-20 A		A90A 0304	A90A 0504	•	•	•	•	•
30 A	0-30 A		A90A 0305	A90A 0505	•				
50 A	0-50 A		A90A 0307	A90A 0507	•				
<b>Rating</b>	<b>Scale 3 In</b>								
5 A	0-5/15 A	•		A90A 0533	•	•	•	•	•
10 A	0-10/30 A	•		A90A 0534	•	•	•	•	•
20 A	0-20/60 A			A90A 0535	•	•	•	•	•
30 A	0-30/90 A			A90A 0536	•				
40 A	0-40/120 A			A90A 0537	•				
<b>Rating</b>	<b>Scale 5 In</b>								
5 A	0-5/25 A		•	•	•	•	•	•	•

## ► Customized products





## ► Connection on CT 5 A

Format	48 x 48	72 x 72	96 x 96	48 x 48	72 x 72	96 x 96	144 x 144	48 x 48	72 x 72	96 x 96	144 x 144
<b>Deflection</b>	Moving iron 50 Hz Panel meter and dial separate 			Moving iron 50 Hz Complete panel meter 				Complete panel meter 			
<b>Ratio</b>	Complete panel meter										
<b>Scale</b>	A90A 0487 A90A 0486 A90A 0485										
<b>TC</b>	Dial only										
5/5 A	0-6.5 A	CADR 0136	CADR 0702	CADR 0492	•	•	•	•	•	•	•
10/5 A	0-13 A	CADR 0137	CADR 0703	CADR 0493	•	•	•	•	•	•	•
15/5 A	0-20 A	CADR 0138	CADR 0704	CADR 0494	•	•	•	•	•	•	•
20/5 A	0-26 A	CADR 0111	CADR 0461	CADR 0441	A90A 0211	A90A 0311	A90A 0511	•	•	•	A250 A0611
25/5 A	0-32.5 A	CADR 0110	CADR 0701	CADR 0486	•	•	•	•	•	•	•
30/5 A	0-40 A	CADR 0112	CADR 0462	CADR 0442	A90A 0212	A90A 0312	A90A 0512	•	•	•	A250 A0612
40/5 A	0-52 A	CADR 0113	CADR 0463	CADR 0443	A90A 0213	A90A 0313	A90A 0513	•	•	•	A250 A0613
50/5 A	0-65 A	CADR 0114	CADR 0464	CADR 0444	A90A 0214	A90A 0314	A90A 0514	•	•	•	A250 A0614
60/5 A	0-80 A	CADR 0115	CADR 0465	CADR 0445	A90A 0215	A90A 0315	A90A 0515	•	•	•	A250 A0615
75/5 A	0-100 A	CADR 0116	CADR 0466	CADR 0446	A90A 0216	A90A 0316	A90A 0516	•	•	•	A250 A0616
100/5 A	0-130 A	CADR 0117	CADR 0467	CADR 0447	A90A 0217	A90A 0317	A90A 0517	•	•	•	A250 A0617
125/5 A	0-165 A	CADR 0118	CADR 0468	CADR 0448	A90A 0218	A90A 0318	A90A 0518	•	•	•	A250 A0618
150/5 A	0-200 A	CADR 0119	CADR 0469	CADR 0449	A90A 0219	A90A 0319	A90A 0519	•	•	•	A250 A0619
200/5 A	0-260 A	CADR 0120	CADR 0470	CADR 0450	A90A 0220	A90A 0320	A90A 0520	•	•	•	A250 A0620
250/5 A	0-325 A	CADR 0121	CADR 0471	CADR 0451	A90A 0221	A90A 0321	A90A 0521	•	•	•	A250 A0621
300/5 A	0-400 A	CADR 0122	CADR 0472	CADR 0452	A90A 0222	A90A 0322	A90A 0522	•	•	•	A250 A0622
400/5 A	0-520 A	CADR 0123	CADR 0473	CADR 0453	A90A 0223	A90A 0323	A90A 0523	•	•	•	A250 A0623
500/5 A	0-650 A	CADR 0124	CADR 0474	CADR 0454	A90A 0224	A90A 0324	A90A 0524	•	•	•	A250 A0624
600/5 A	0-800 A	CADR 0125	CADR 0475	CADR 0455	A90A 0225	A90A 0325	A90A 0525	•	•	•	A250 A0625
750/5 A	0-1 kA	CADR 0126	CADR 0476	CADR 0456	A90A 0226	A90A 0326	A90A 0526	•	•	•	A250 A0626
800/5 A	0-1.04 kA	CADR 0135	CADR 0481	CADR 0487	•	•	•	•	•	•	•
1000/5 A	0-1.3 kA	CADR 0127	CADR 0477	CADR 0457	A90A 0227	A90A 0327	A90A 0527	•	•	•	A250 A0627
1250/5 A	0-1.65 kA	CADR 0128	CADR 0478	CADR 0458	A90A 0228	A90A 0328	A90A 0528	•	•	•	A250 A0628
1500/5 A	0-2 kA	CADR 0129	CADR 0479	CADR 0459	A90A 0229	A90A 0329	A90A 0529	•	•	•	A250 A0629
2000/5 A	0-2.6 kA	CADR 0130	CADR 0480	CADR 0460	A90A 0230	A90A 0330	A90A 0530	•	•	•	A250 A0630
2500/5 A	0-3.25 kA	CADR 0131	CADR 0482	CADR 0488	•	A90A 0331	A90A 0531	•	•	•	•
3000/5 A	0-4 kA	CADR 0132	CADR 0483	CADR 0489	•	A90A 0332	A90A 0532	•	•	•	•
4000/5 A	0-5.2 kA	CADR 0133	CADR 0484	CADR 0490	•	•	•	•	•	•	•
5000/5 A	0-6.5 kA	CADR 0134	CADR 0485	CADR 0491	•	•	•	•	•	•	•
<b>Ratio</b>	Complete panel meter										
<b>Scale</b>	A90A 0107 A90A 0106 A90A 0105										
<b>TC</b>	Dial only										
5/5 A	0-5/15 A	CADR 0139	CADR 0169	CADR 0059	A90A 0239	A90A 0339	A90A 0539	•	•	•	A250 A0639
10/5 A	0-10/30 A	CADR 0140	CADR 0170	CADR 0060	A90A 0240	A90A 0340	A90A 0540	•	•	•	A250 A0640
15/5 A	0-15/45 A	CADR 0141	CADR 0171	CADR 0061	A90A 0241	A90A 0341	A90A 0541	•	•	•	A250 A0641
20/5 A	0-20/60 A	CADR 0142	CADR 0172	CADR 0062	A90A 0242	A90A 0342	A90A 0542	•	•	•	A250 A0642
25/5 A	0-25/75 A	CADR 0167	CADR 0168	CADR 0087	•	•	•	•	•	•	•
30/5 A	0-30/90 A	CADR 0143	CADR 0173	CADR 0063	A90A 0243	A90A 0343	A90A 0543	•	•	•	A250 A0643
40/5 A	0-40/120 A	CADR 0144	CADR 0174	CADR 0064	A90A 0244	A90A 0344	A90A 0544	•	•	•	A250 A0644
50/5 A	0-50/150 A	CADR 0145	CADR 0175	CADR 0065	A90A 0245	A90A 0345	A90A 0545	•	•	•	A250 A0645
60/5 A	0-60/180 A	CADR 0146	CADR 0176	CADR 0066	A90A 0246	A90A 0346	A90A 0546	•	•	•	A250 A0646
75/5 A	0-75/225 A	CADR 0147	CADR 0177	CADR 0067	A90A 0247	A90A 0347	A90A 0547	•	•	•	A250 A0647
100/5 A	0-100/300 A	CADR 0148	CADR 0178	CADR 0068	A90A 0248	A90A 0348	A90A 0548	•	•	•	A250 A0648
125/5 A	0-125/375 A	CADR 0149	CADR 0179	CADR 0069	A90A 0249	A90A 0349	A90A 0549	•	•	•	A250 A0649
150/5 A	0-150/450 A	CADR 0150	CADR 0180	CADR 0070	A90A 0250	A90A 0350	A90A 0550	•	•	•	A250 A0650
200/5 A	0-200/600 A	CADR 0151	CADR 0181	CADR 0071	A90A 0251	A90A 0351	A90A 0551	•	•	•	A250 A0651
250/5 A	0-250/750 A	CADR 0152	CADR 0182	CADR 0072	A90A 0252	A90A 0352	A90A 0552	•	•	•	A250 A0652
300/5 A	0-300/900 A	CADR 0153	CADR 0183	CADR 0073	A90A 0253	A90A 0353	A90A 0553	•	•	•	A250 A0653
400/5 A	0-0.4/1.2 kA	CADR 0154	CADR 0184	CADR 0074	A90A 0254	A90A 0354	A90A 0554	•	•	•	A250 A0654
500/5 A	0-0.5/1.5 kA	CADR 0155	CADR 0185	CADR 0075	A90A 0255	A90A 0355	A90A 0555	•	•	•	A250 A0655
600/5 A	0-0.6/1.8 kA	CADR 0156	CADR 0186	CADR 0076	•	A90A 0356	A90A 0556	•	•	•	•
750/5 A	0-0.75/2.25 kA	CADR 0157	CADR 0187	CADR 0077	•	A90A 0357	A90A 0557	•	•	•	•
800/5 A	0-0.80/2.4 kA	CADR 0158	CADR 0188	CADR 0078	•	•	•	•	•	•	•
1000/5 A	0-1/3 kA	CADR 0159	CADR 0189	CADR 0079	•	•	•	•	•	•	•
1200/5 A	0-1.2/3.6 kA	CADR 0160	CADR 0190	CADR 0080	•	•	•	•	•	•	•
1500/5 A	0-1.5/4.5 kA	CADR 0161	CADR 0191	CADR 0081	•	•	•	•	•	•	•
2000/5 A	0-2/6 kA	CADR 0162	CADR 0192	CADR 0082	•	•	•	•	•	•	•
2500/5 A	0-2.5/7.5 kA	CADR 0163	CADR 0193	CADR 0083	•	•	•	•	•	•	•
3000/5 A	0-3/9 kA	CADR 0164	CADR 0194	CADR 0084	•	•	•	•	•	•	•
4000/5 A	0-4/12 kA	CADR 0165	CADR 0195	CADR 0085	•	•	•	•	•	•	•
5000/5 A	0-5/15 kA	CADR 0166	CADR 0196	CADR 0086	•	•	•	•	•	•	•

## ► Associated products

Accessories

► page 223

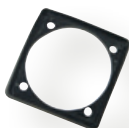

CT Current transformers

► page 102







# NORMEUROPE Range

Analogue panel meters

Measurement and instrumentation

## ■ Deflection <sup>90°</sup>

**Standard scale model**  
**Accuracy class:** 1.5  
**Measuring component:** moving iron  
 50-60-400 Hz and rectified moving coil  
 50-10,000 Hz  
 Pseudo linear scale (iron)  
 Interchangeable dial, except 144 x 144  
**Consumption:** 4.5 VA max  
**Extended scale model**  
**Accuracy class:** 1.5  
**Measuring component:** moving iron  
 50-60-400 Hz  
 Pseudo linear scale  
**Consumption:** 2.5 VA  
 With additional "A" unit for 48 x 48  
 format in 250° and 90° if value < 100 V

## ■ Deflection <sup>250°</sup>

**Standard scale model**  
**Accuracy class:** 1.5  
**Measuring component:** rectified  
 moving coil 50-10,000 Hz  
 Linear scale  
 Impedance 1 kΩ/V  
**Extended scale model**  
**Accuracy class:** 1.5  
**Measuring component:** rectified  
 moving coil 50-10,000 Hz  
 Linear scale  
 Impedance 2 kΩ/V  
 With additional "A" unit in 48 x 48  
 format in 250° and 90° if value < 100 V

## AC Voltmeter



### ► Feasibility limits

Deflection	<sup>90°</sup>				<sup>250°</sup>				
	Format	48 x 48	72 x 72	96 x 96	144 x 144	48 x 48	72 x 72	96 x 96	144 x 144
<b>Direct connection</b>									
Scale	Moving iron	15 to 600 V				3 to 600 V			
Vn: 1.2 Vn	Moving coil	1.5 to 600 V				3 to 600 V			
Extended scale		10-15, 20-30, 40-70, 75-120, 80-120, 90-130, 90-140, 100-150, 200-300, 400-600 V				40-70, 80-120, 96-144, 100-150, 400-600 V			
<b>Connection on VT</b>									
Scale according to client specifications		from Un/ 100/√3 V				from Un/ 100/√3 V			

### ► Direct connection

Deflection	Iron 50 Hz <sup>90°</sup>				<sup>250°</sup>				
	Format	48 x 48	72 x 72	96 x 96	144 x 144	48 x 48	72 x 72	96 x 96	144 x 144
<b>Rating Scale Vn</b>									
15 V	0-15 V	•	•	•	•	•	•	•	•
30 V	0-30 V	•	•	•	•	•	•	•	•
60 V	0-60 V	•	•	•	•	•	•	•	•
150 V	0-150 V	•	•	•	•	•	•	•	•
250 V	0-250 V	A90V 0266	A90V 0366	A90V 0566	•	•	•	A250 0666	•
300 V	0-300 V	A90V 0268	A90V 0368	A90V 0568	•	•	•	A250 0668	•
500 V	0-500 V	A90V 0267	A90V 0367	A90V 0567	•	•	•	A250 0667	•
<b>Rating Extended scale</b>									
230 V	150-260	•	•	A90V 0588	•	•	•	•	•
400 V	300-450	•	•	A90V 0589	•	•	•	•	•

### ► Connection on VT

Deflection	Iron 50 Hz <sup>90°</sup>				<sup>250°</sup>				
	Format	48 x 48	72 x 72	96 x 96	144 x 144	48 x 48	72 x 72	96 x 96	144 x 144
<b>VT ratio Scale</b>									
TT/100 V	0-1.2 Vn	•	•	•	•	•	•	•	•
TT/100/√3 V	0-1.2 Vn	•	•	•	•	•	•	•	•

### ► Customized products

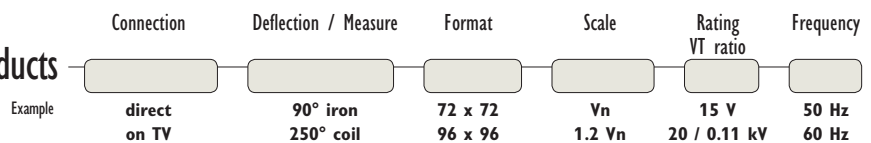

### ► Associated products



Accessories

► page 223



# Frequency meter

## Pointer frequency meter

■ Deflection  

**Accuracy class:** 0.5 of  $F_n$

**Measuring component:** moving coil and frequency converter

**Linear scale**

**Domain of use:** 0.80  $U_n$  to 1.15  $U_n$

With additional "A" unit for 48 x 48 format in 250° and 90° if value < 100 V

**Consumption:** 3 VA



## ► Feasibility constraints

Voltage 57.7 V to 440 V and frequency 50 to 400 Hz

Format		72 x 72	96 x 96	144 x 144
<b>Rated voltage</b>	<b>Measurement range</b>	<b>Deflection </b>		
100 V	45-55 Hz	•	•	•
	55-65 Hz	•	•	•
230 V	45-55 Hz	•	FA90 0681	•
	55-65 Hz	•	•	•
400 V	45-55 Hz	•	FA90 0682	•
	55-65 Hz	•	•	•

Format		72 x 72	96 x 96	144 x 144
<b>Rated voltage</b>	<b>Measurement range</b>	<b>Deflection </b>		
100 V	45-55 Hz	•	•	•
	55-65 Hz	•	•	•
230 V	45-55 Hz	•	•	•
	55-65 Hz	•	•	•
400 V	45-55 Hz	•	•	•
	55-65 Hz	•	•	•

## ► Customized products

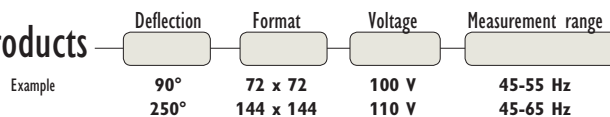

## ► Associated products

Accessories

► page 223



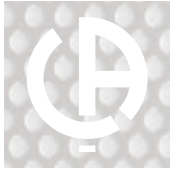

# NORMEUROPE Range

## Maximum demand ammeter

Analogue panel meters

Measurement and instrumentation

■ Deflection 90°

**Accuracy class:** 3

**Measuring component:** spiralled double reed  
(I rms avg.)

**Frequency:** 0-400 Hz

**Overload capacity:**

1.5 I<sub>n</sub> permanent

10 I<sub>n</sub> for 1 s

**Consumption:** 3 VA

Pointer guided by measurement component and adjustable by button on front panel



### ► Feasibility limits

Hour meter power supply from 24 V to 440 V at 50 or 60 Hz for model 161B.

### ► Connection on CT

Model (I max)	Integration Time	Calibre	Graduation	Deflection	
				72 x 72	96 x 96
<b>101B</b>	8 min	7.5 A	according to primary CT / 5 A	•	
	15 min				•
<b>131B</b> With relay, breaking capacity 10 VA resistive, 250 Vac max or 0.5 A	8 min			•	•
	15 min			•	•
<b>161B</b> With hour meter 230 V - 50 Hz, 99,999.99 h	8 min			•	•
	15 min			•	•

• Parameters to be indicated when ordering

### ► Customized products

Example

Format	Model	Integration time	Primary CT	Hour meter supply
72 x 72 96 X 96	101 B 161 B	15' 8'	100 / 5 A 600 / 5 A	100 V - 60 Hz

### ► Associated products

Accessories

► page 223

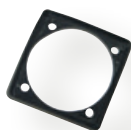

CT Current transformers

► page 102



# Wattmeter Varmeter

## Deflection

**Linear scale**, measurement range according to client specifications (absorbed or generated power)

**Measuring component:** moving coil 2 mA and electrical circuit in additional "B" unit.

**Accuracy class:** 1.5

**Consumption:**  
Current circuit 0.3 VA at In  
Voltage circuit 2.5 VA at Un

## Overload capacity:

Current circuit:  
1.5 In permanent  
10 In for 5 s  
30 In for 3 s  
Voltage circuit:  
1.3 permanent  
2 Un for 10 s  
Domain of use:  
between 0.8 and 1.3 Sn  
Voltage 0.8 to 1.15 Un  
Current 0 to 1.2 In  
Frequency  $\pm 5$  Hz



## Feasibility limits

Voltage 57.7 V to 440 V

Network			Frequency	Current	Voltage	Deflection			Deflection		
				Connection		72 x 72	96 x 96	144 x 144	72 x 72	96 x 96	144 x 144
Single phase	mono	active	50 Hz or 60 Hz or 400 Hz	on TC/1 A or TC/5 A	direct 230 V or 400 V	.	.	.	.	.	.
Balanced three-phase 3 wires	TE3F	active									
Balanced three-phase 4 wires	TE4F	active									
Unbalanced three-phase 3 wires	TNE3F	active									
Unbalanced three-phase 4 wires	TNE3F	reactive			on TT 100/ $\sqrt{3}$ 110/ $\sqrt{3}$ 100 110 - 230 or 400 V						
	TNE4F	active									
	TNE4F	reactive									
	TNE4F	reactive									

• Parameters to be indicated when ordering

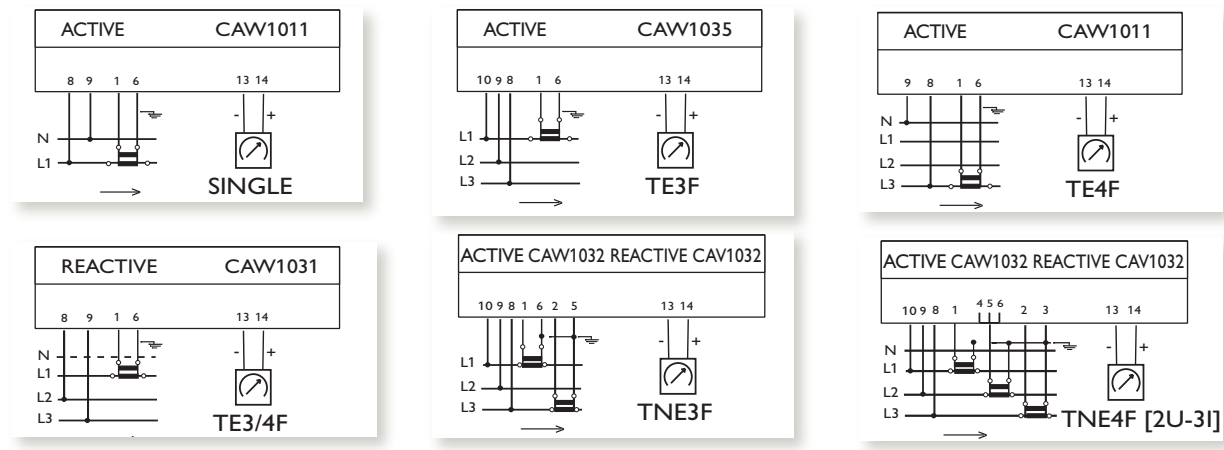

## Customized products

Network	Deflection	Format	Frequency	CT ratio	Direct / VT	Voltage or VT ratio	Scale beginning	Scale ending
Active single	90°	72 x 72	50 Hz	1000 / 5 A	Direct	230 V	0 kW	250 kW
Reactive balanced three-phase 3 wires	250°	96 x 96	60 Hz	400 / 5 A	TT	20 kV / 115 V	- 12 Mvar	+ 12 MVar

## Associated products

Accessories [page 223](#)  
CT Current transformers [page 102](#)



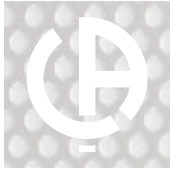

# NORMEUROPE Range

## Phasemeters

Analogue panel meters

■ Deflection  $90^\circ$   $250^\circ$

Scale in  $\cos \varphi$

**Measuring component:**

Moving coil and electronic circuit in additional "B" unit.

**Accuracy class:** 2.5

**Consumption:**

Circuit current 0.3 VA

Circuit voltage 0.2 VA

**Overload capacity:**

Current circuit 2 In permanent

10 In for 5 s

Voltage circuit 1.3 Un permanent

2 Un for 10 s

**Operating range:**

Voltage 0.8 to 1.2 Un

Current 0.2 to 1.2 In

Frequency  $\pm 5$  Hz

■ Deflection  $360^\circ$

Scale 4 quadrants in  $\cos \varphi$

Additional "B" unit

**Accuracy class:** 1.5

**Consumption:**

Current circuit 0.5 VA

Voltage circuit 10 VA

**Overload capacity:**

Current circuit 1.2 In permanent

10 In for 5 s

Voltage circuit 1.2 Un permanent

2 Un for 5 s

**Operating range:**

Voltage 0.8 to 1.2 Un

Current 0.2 to 1.2 In

Frequency  $\pm 5$  Hz



### ► Feasibility limits

Voltage 57.7 to 440 V, other measurement ranges

Network	Frequency	Secondary CT	Voltage	Measurement range	Deflection $90^\circ$			Deflection $250^\circ$			Deflection $360^\circ$		
					72 x 72	96 x 96	144 x 144	72 x 72	96 x 96	144 x 144	96 x 96	144 x 144	
Single or balanced 3-phase 3/4 wires	50 Hz or 60 Hz	1 A or 5 A	100 V	0.5 lead/1/0.2 lag	.	.	.	.	.	.	.	.	
Unbalanced 3-phase 3/4 wires			110 V	0.5 lead/1/0.5 lag									
			230 V										
			400 V	-1 / 0 / +1							.	.	

### ► Block diagram

• Parameters to indicate when ordering

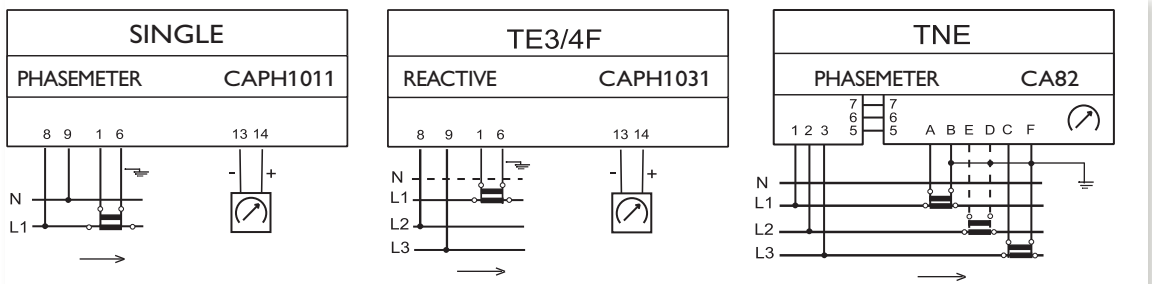

### ► Customized products

Examples	Network	Deviation	Format	Frequency	Secondary CT	Voltage	Measurement range
SINGLE		$250^\circ$	72 x 72	50 Hz	5 A	230 V	0.5 lead /1/0.5 lag
Unbalanced three-phase		$360^\circ$	144 x 144	60 Hz	1 A	440 V	-1 / 0 / +1

### ► Associated products

Accessories

► page 223



CT Current transformers

► page 102



# Synchronizers

## Synchronoscope



**Deflection**  $360^\circ$   
**Accuracy class:** 1.5  
**Three-phase network:**  
 2-wire connection  
**Consumption:**  
 Reference current 1.5 VA  
 Circuit generator 5 VA  
**Operating range:** 0.8 to 1.2  $U_n$   
**Overload capacity:** 1.2  $U_n$   
 permanent 2  $U_n$  for 5 s  
**Additional unit "B"**

### ► Feasibility limits

Voltage 57.7 V to 440 V

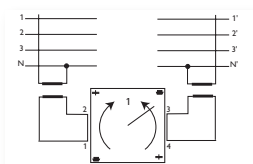

Deflection $360^\circ$		96 x 96	144 x 144
<b>Format</b>			
<b>Frequency Voltage</b>			
	100/ $\sqrt{3}$ V	•	•
50 Hz	100 V	SYNC 0686	•
	230 V	SYNC 0687	•
	400 V	•	•
	100/ $\sqrt{3}$ V	•	•
60 Hz	100 V	•	•
	230 V	•	•
	400 V	•	•
Phase lamp		2318635001	2318635001

### ► Customized products

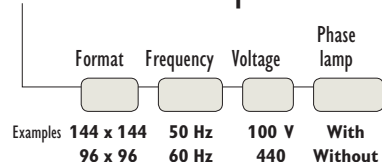

## Vibrating-reed double frequency meter



**Accuracy class:** 0.5  
**Consumption:** 3 VA  
**Operating range:** 0.8 to 1.15  $U_n$   
**Measuring component:** vibrating reed in field of coil  
**Amplitude of vibration:** proportional to  $V^2$

### ► Feasibility limits

Voltage 57.7 V to 440 V

2 rows of 9 segments		72 x 72	96 x 96	144 x 144
<b>Format</b>				
<b>Frequency Voltage</b>				
	100/ $\sqrt{3}$ V	•	•	•
48-52 Hz	100 V	•	FL12 0677	•
	230 V	•	FL12 0678	•
	400 V	•	FL12 0679	•
	100/ $\sqrt{3}$ V	•	•	•
58-62 Hz	100 V	•	•	•
	230 V	•	•	•
	400 V	•	•	•

### ► Customized products

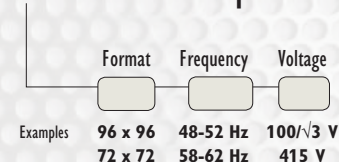

## Differential Voltmeter



**Deflection**  $90^\circ$   $250^\circ$   
**Accuracy class:** 2.5  
**Consumption:** 0.5 VA per circuit  
**Frequency:** 50-60 Hz  
**Measurement range:** 0.75 to 1.25  $U_n$   
**Additional unit "B"**

### ► Feasibility limits

Measurement range, other...  
 Voltage 57.7 V to 440 V

Deflection $90^\circ$		72 x 72	96 x 96	144 x 144
<b>Format</b>				
<b>Voltage <math>U_n</math></b>				
	100/ $\sqrt{3}$ V	•	•	•
	100 V	•	BASS 0591	•
	230 V	•	BASS 0592	•
	400 V	•	BASS 0593	•

Deflection $250^\circ$		72 x 72	96 x 96	144 x 144
<b>Format</b>				
<b>Voltage <math>U_n</math></b>				
	100/ $\sqrt{3}$ V	•	•	•
	100 V	•	C250 0691	•
	230 V	•	•	•
	400 V	•	•	•

### ► Customized products

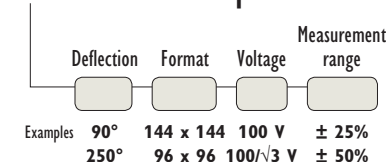

### ► Associated products

Accessories

► page 223

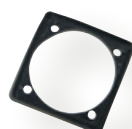



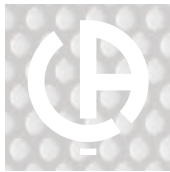



# NORMEUROPE Range



## DC Anmeter





■ Deflection  **Accuracy class:** 1.5  
(option class 1 except 48 x 48)  
**Measuring component:**  
Moving coil  
Linear scale  
Interchangeable dial, except 144 x 144  
**Voltage drop:**  
60 mV for 50 mA rating  
variable for rating < 50 mA

■ Deflection  **Accuracy class:** 1.5  
**Measuring component:**  
Moving coil  
Linear scale  
**Voltage drop:** 100 mV for 10 mA  
rating variable for rating < 10 mA



### ► Feasibility limits

Deflection									
Format		48 x 48	72 x 72	96 x 96	144 x 144	48 x 48	72 x 72	96 x 96	144 x 144
Direct connection	Zero position, left or central	50 mA to 20 A		50 µA to 75 A		500 µA to 12 A			
Process signal connection	Zero position set	4-20 mA 10-50 mA		2-10 mA		4-20 mA	10-50 mA	2-10 mA	4-23,2 mA
Shunt connection	Zero position, left or central	50 mV 150 mV	60 mV 300 mV	100 mV 360 mV	120 mV 300 mV	50 mV	60 mV	100 mV	120 mV

### ► Direct connection

Deflection									
Format		48 x 48	72 x 72	96 x 96	144 x 144	48 x 48	72 x 72	96 x 96	144 x 144
Rating	Scale								
5 A	0-5 A	•	•	•	•	•	•	•	•
10 A	0-10 A	•	•	•	•	•	•	•	•
15 A	0-15 A	•	•	•	•				
25 A	0-25 A		•	•	•				

### ► Connection on 100 mV shunt

Deflection									
Format		48 x 48	72 x 72	96 x 96	144 x 144	48 x 48	72 x 72	96 x 96	144 x 144
Shunt	Scale 1.2 In								
5 A	0-6 A	•	•	•	•	•	•	•	•
10 A	0-12 A	•	C90S 1400	C90S 1500	•	•	•	•	•
15 A	0-18 A	•	•	•	•	•	•	•	•
20 A	0-24 A	•	•	•	•	•	•	•	•
25 A	0-30 A	•	C90S 1403	C90S 1503	•	•	•	•	•
30 A	0-36 A	•	•	•	•	•	•	•	•
40 A	0-48 A	•	•	•	•	•	•	•	•
50 A	0-60 A	•	C90S 1406	C90S 1506	•	•	•	•	•
60 A	0-72 A	•	•	•	•	•	•	•	•
75 A	0-90 A	•	C90S 1408	C90S 1508	•	•	•	•	•
100 A	0-120 A	•	C90S 1409	C90S 1509	•	•	•	•	•
125 A	0-150 A	•	•	•	•	•	•	•	•
150 A	0-180 A	•	C90S 1411	C90S 1511	•	•	•	•	•
200 A	0-240 A	•	•	•	•	•	•	•	•
250 A	0-300 A	•	C90S 1413	C90S 1513	•	•	•	•	•
300 A	0-360 A	•	•	•	•	•	•	•	•
400 A	0-480 A	•	•	•	•	•	•	•	•
500 A	0-600 A	•	C90S 1416	C90S 1516	•	•	•	•	•
600 A	0-720 A	•	•	•	•	•	•	•	•
1000 A	0-1200 A	•	•	•	•	•	•	•	•

### ► Customized products

Connection	Deflection	Format	Zero position	Rating	Beginning/end of scale
Examples direct process signal	90° 250°	72 x 72 96 x 96	left set	60 A 4-20 mA	0-60 A 0-1500 rpm

### ► Associated products

Accessories  page 223

Shunts  page 144

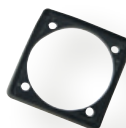



# DC Voltmeter





■ **Deflection**  **90°**  
**Accuracy class:** 1.5  
 (option class 1 except 48 x 48)  
**Measuring component:**  
 Moving coil  
 Linear scale  
**Consumption:**  
 1 mA for  $U_n \geq 500$  mV  
 5 mA for  $U_n < 500$  mV

■ **Deflection**  **250°**  
**Accuracy class:** 1.5  
**Measuring component:**  
 Moving coil  
 Linear scale  
**Consumption:**  
 1 mA for  $U_n \geq 1$  V  
 2 mA for  $U_n \geq 1$  V (central zero)  
 5 mA for  $U_n < 1$  V

## ► Feasibility limits

Deflection		 90°				 250°			
		48 x 48	72 x 72	96 x 96	144 x 144	48 x 48	72 x 72	96 x 96	144 x 144
Direct connection	Zero position, left or central	50 mV to 600 V				50 mV to 600 V			
Process signal connection	Zero position, left	from 50 mV				from 50 mV			
	Set zero position					1-5 V 2-10 V			

## ► Direct connection

Deflection		 90°				 250°			
		48 x 48	72 x 72	96 x 96	144 x 144	48 x 48	72 x 72	96 x 96	144 x 144
Rating	Scale								
15 V	0-15 V	•	•	•	•	•	•	•	•
30 V	0-30 V	•	C90S 1425	C90S 1525	•	•	•	•	•
60 V	0-60 V	•	C90S 1426	C90S 1526	•	•	•	•	•
75 V	0-75 V	•	•	•	•	•	•	•	•
150 V	0-150 V	•	C90S 1428	C90S 1528	•	•	C250 1928	•	•
300 V	0-300 V	•	•	•	•	•	•	•	•

## ► Customized products

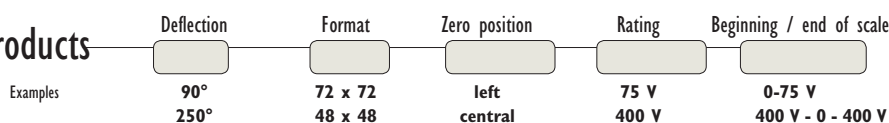

## ► Associated products

Accessories

► page 223

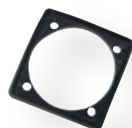



# NORMEUROPE Range

## Command function meter

Analogue panel meters

Measurement and instrumentation

■ Deflection 90°

**Format:** 96 x 96

**Accuracy class:** 1.5

**Threshold index** (with or without indicator)

**Consumption:**

I input: 1 VA (if AC); 100 mV (if DC)

V input: 1 mA (if AC); 1 mA (if DC > 0.5 V and 5 mA if below)

Relay: adjustable from 0 to 100% of scale (accuracy threshold ± 1%)

Response time < 500 ms; Hysteresis: 1% ± 0.5%

Breaking capacity 5A / 230V - 50 Hz - resistive

Triple insulation

measurement / power / relay contacts: 2 kV - 50 Hz - 1min

**Auxiliary power supply**

Tolerance: +10%, -15%; Frequency: 50 - 400 Hz

Consumption: 2.6 VA max



### ► Feasibility limits

Function	Zero position frequency	Rating	Graduation	Auxiliary supply	Number of relays	Mode
AC ammeter	Frequency 50 or 60 Hz	Direct or on CT 1 mA to 7.5 A	according to client specifications	100 Vac to 400 Vac	1 or 2 change overcontact	A1 A2 B1 B2
AC voltmeter		Direct or on VT from 4 to 600 V				
DC ammeter	Left or central zero position	Direct 1mA to 1A shunt 50 to 300 mV				
DC voltmeter		Direct from 0.1 to 400 V				
Temperature		Pt100 2/3 wire JKNST thermocouple				

Parameters to be specified when ordering

### ► Operating relay status

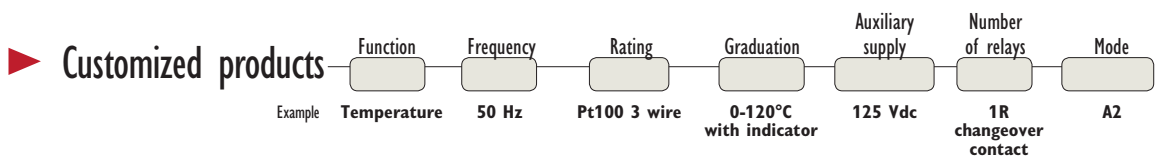
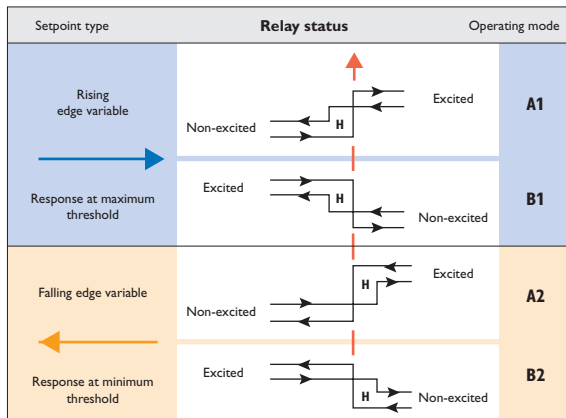

### ► Associated products

Accessories

► page 223

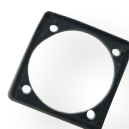

CT Current transformers

► page 102



Shunts

► page 144



# SYNCHRONIZATION Column

Synchronoscope



Vibrating-reed double frequency meter



Differential voltmeter



Phasemeter





# COHO Range

Hour meters for totalling the operating time of machines or equipment for control and maintenance

Hour meters  
Measurement and instrumentation

**PRODUCT ADVANTAGES**

- + **FOR SEVERE ENVIRONMENTS**
- + **ENHANCED RELIABILITY RANGE**



## ► General specifications

**Reference standard:** NFC 42310

**Display:** without reset function, white on black background, decimals in red  
Height of digits: 4 mm

AC and DC capacity: 99,999.99 h  
Operating indicator: scrolling 1/100 h every 36 s

**Motor in Vac/Vdc:** pulse + electronic counter

**Consumption:**  
0.5 VA in 24 Vac/dc, 1.5 VA in 48 Vac/dc,  
2 VA in 110/230 Vac, 6 VA in 400 Vac

**Operating range:**  
Voltage Vac: -15% +10%  
Frequency:  $\pm 5$  Hz  
Voltage Vdc:  $\pm 20\%$

**Insulation:** double

**Dielectric test voltage:**  
5.5 kV - 50 Hz - 1 min

**Environment:**  
Operating temperature: -10°C to +60°C  
Relative humidity: < 95% at +45°C

**Protection rating on front panel:**  
standard: IP50, option: IP55

**Electromagnetic compatibility**  
(emission and immunity): EN 61326-1

**Mounting:**  
Standard version: elastic joint  
IP55 version: joint + strap

**Weight:** 180 g

**Connection:** 6.35 Faston clips + terminal covers included

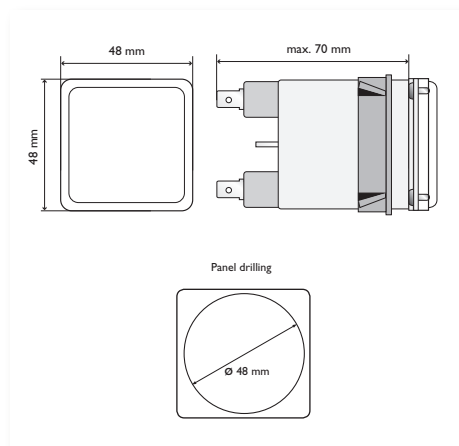

Format		48 x 48 (IP50)	48 x 48 (IP55)
50 Hz	24 V	COHO 0606	COHO 1606
	48 V	COHO 0607	COHO 1607
	110 V	COHO 0608	COHO 1608
	230/400 V	COHO 0610	COHO 1610
60 Hz	24 V	COHO 0627	COHO 1627
	48 V	COHO 0628	COHO 1628
	110 V	COHO 0629	COHO 1629
DC	230/400 V	COHO 0631	COHO 1631
	24 V	COHO 0604	COHO 1604
	48 V	COHO 0605	COHO 1605



# LK Range

Hour meters (7 or 8 digits) for totalling the operating time of machines or equipment for control and maintenance

## PRODUCT ADVANTAGES

- + EASY TO INSTALL**
- + ECONOMICAL**

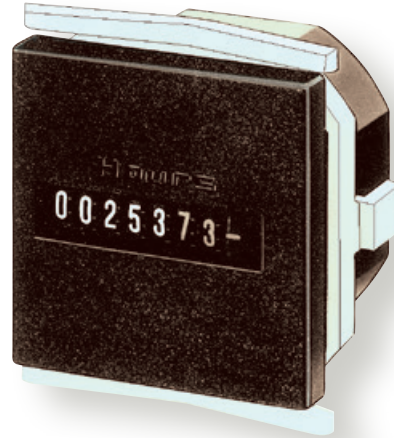

## ► General specifications

**Display:** without reset function, white on black background, decimals in red  
 Height of digits: 4 mm  
 AC capacity: 99,999.99 h  
 DC capacity: 999,999.99 h  
 Operating indicator in Vac: ridged roll  
 Operating indicator in Vdc: continuous scrolling 1/100h every 36 s  
**Motor in Vac:** synchronous  
**Motor in Vdc:** step-by-step  
**Consumption:** Vdc: ≤ 750 mW  
 Vac: ≤ 1.65 VA

**Insulation:** single  
**Dielectric test voltage:** 2 kV - 50 Hz - 1 min  
**Operating range:**  
 Voltage Vac: ± 10%  
 Frequency: ± 10%  
 Voltage Vdc: ± 10%  
**Environment:**  
 Operating temperature: -15°C to +50°C  
 Relative humidity: < 95% at +45°C  
**Protection rating on front panel:** IP52  
**Mounting:** self-locking flange  
**Weight:** 50 g  
**Connection:** 6.35 lugs or Faston clips

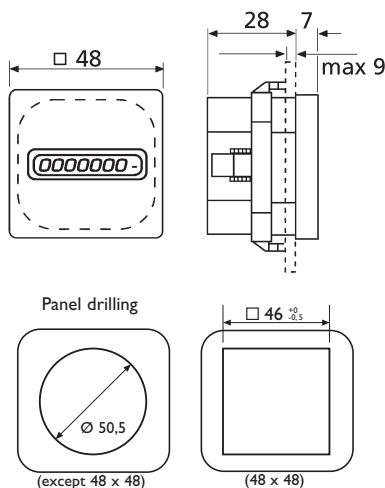

Format		48 x 48	55 x 55	72 x 72
50 Hz	24 V	LK4N 001N	LK5N 001N	LK7N 001N
	48 V	LK4N 003N	LK5N 003N	LK7N 003N
	115 V	LK4N 005N	LK5N 005N	LK7N 005N
	230 V	LK4N 007N	LK5N 007N	LK7N 007N
	400 V	LK4N 009N	LK5N 009N	LK7N 009N
60 Hz	24 V	LK4N 002N	LK5N 002N	LK7N 002N
	48 V	LK4N 004N	LK5N 004N	LK7N 004N
	115 V	LK4N 006N	LK5N 006N	LK7N 006N
	230 V	LK4N 008N	LK5N 008N	LK7N 008N
	400 V	LK4N 010N	LK5N 010N	LK7N 010N
DC	10-30 V	LK4N 011N	LK5N 011N	LK7N 011N
	36-80 V	LK4N 012N	LK5N 012N	LK7N 012N
	110-130 V	LK4N 013N	LK5N 013N	LK7N 013N
front panel only			LK5N 0000	LK7N 0000





# Automation relays

Automation relays

## Instantaneous relays

### Monostables

► catalog 906130103

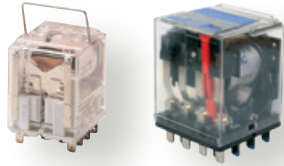

### Bistables

► catalog 906130103



### Fast-acting

► catalog 906130103

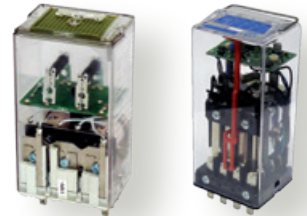

## Time-delay relays

### Time-delay

► catalog 906130103

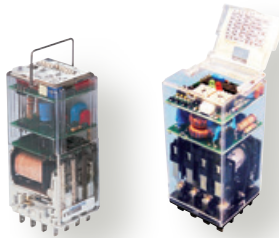

### Solid-state timer

► catalog 906130103



## Function relays

### Flash relay, impulse relay, step relay, control relay

► catalog 906130103



## Sockets and accessories

**Rear connection, front connection, screw connection, Faston connection, blade connection, spring connection:** various sockets are available. Energis® also proposes a complete range of accessories: **locking spring, bar-mounting strap, bar** for panel mounting, DIN-rail fitting, **safety blank, etc.**

► catalog 906130103



# The reference for industrial relays

**The French measurement instrument designer and manufacturer Chauvin Arnoux Group** is acknowledged as a major player in the electrical sector. At the heart of electrical measurement activities, it plays a crucial role in the implementation of energy management and control systems. Its scope covers applications as diverse as basic measurement of electrical parameters, network monitoring – from energy production through to distribution to end-users – safety of property and people, equipment maintenance and energy supply quality.

Nuclear power, petrochemicals, rail transport, industry: there are relays for every sector of activity. Some are covered by particularly strict standards so that they can handle the constraints of the environment in which they will be operating:

- Temperature withstand
- Fire resistance
- Resistance to corrosive gases
- Shock resistance
- Vibration resistance
- Dust resistance
- Contact materials
- Type of magnetic circuit
- Surface treatments and finishes

## ► Three brands, one business

Inside the Chauvin Arnoux Group, **Enerdis** offers the electrical industry and the tertiary sector all the fixed electrical switchboard equipment necessary to measure, control and monitor the power distribution chain. Drawing on more than sixty years' experience, the group proposes its **expertise in control relays for severe environments** such as the nuclear industry, petrochemicals or rail transport. It is also backed by the expertise and know-how of the Group's Italian subsidiary, **AMRA Spa**, which has been making electro-mechanical relays since 1975. With its integration of relays made by **RIA – MTI**, a well-known manufacturer since 1957, Enerdis is now a major player in the world of control relays.

## ► Specific standards and certifications





### RAIL

NF-F 16-101, NF-F 16-102 (materials),  
NF-F 62002, CF 62003, UIC 616-0,  
**SNCF and RATP-approved relays:** F-OK B, F-OK TBAO, F-OK TBOR

### ENERGY

Category K3 (seismic stresses), EDF qualification for use in nuclear power stations. **Enerdis relays are recommended by EDF for EPRs** (European Pressurized Reactors).  
EDF: HM-2A / 03 / 111 / A  
ENEL: LV15/1, LV15/2 / LV16/1, LV16/2, LV16/3, LV16/4, LV16/5

## ► Applications and conformity

	 Energy	 Energy	 Railway	 Substation
Relay ranges	<b>EDF</b> <sup>(1)</sup>	<b>ENEL</b> <sup>(1)</sup> – <b>TERNA</b> <sup>(1)</sup>	<b>Rolling stock</b>	<b>Substation</b>
	RE 3000N (48 Vdc et/ and 125 Vdc)	POK / POKS	F-OK B	POK / BiPOK – POKS / BiPOKS
	OKB184 (48 Vdc et/ and 125 Vdc)	BiPOK / BiPOKS	F-OK TBAO / TBOR	OK-TmS
		OKTmS	POK / BiPOK – POKS / BiPOKS	OK T
		OKBA	OK SFcUIC	RCME / RDME
		RV	OK SCd	RDTE
		BAS8	BiPOK-RA	RGME
		RMME1y	OK-TmS	RGMZ
		RDTE	OK T	RGBE
		RMNE1y	UTM	RMME
		RMBZ	OKRe-L / OKCL / TOK-L	RMNE
		RGME	OKRe-FP / TOK-FP	RMBE
		RGLE13	RGMZ59	RMDE
		RGBE	OKPP	OKSfc
		RMMV1y	OKPh	
		OKSfc – OKFc		
	RCME – RDME			
	RGMV1y			
	RGBZ			
	RMBZ			

<sup>(1)</sup> EDF: French national electricity company  
ENEL: Italian national electrical power production company  
TERNA: Italian national electrical power distribution company



# Product selection guide by functions

Automation relays

In	Model	Monostable	Bistable	Fast-acting	
				Monostable	Bistable
5 – 10 A	POK, BiPOK, TriPOK				
10 A	OKN, OKFc, OKB184, OKSCd, OKSGcCd, OKSFcUIC				
10 A	F-OK B				
10 A	OK Bi				
10 A	OK BA				
10 A	BAS8				
10 A	RE3000, RE3000S, RE3000N				
5 – 7 A	RI				
5 A	RV				
10 A	RCME, RDME				
12 A	RGME				
12 A	RGMZX				
12 A	RGBE				
10 A	RGMV1				
12 A	RGBZ				
10 A	RMME				
10 A	RMNE				
10 A	RMBE				
10 A	RMBZ				
10 A	RMDE				
10 A	RMMV1				
10 A	RMMZ11				
10 A	RMBZ30				
5 A	OK TmF, OK TmS				
5 A	OK TaB, OK TrB, OK TtB				
10 A	TOK				
-	F-OK TBAO / TBOR				
-	UTM				
10 A	RDTE				
5 – 10 A	OKCL, OKRe-L, TOK-L				
5 – 10 A	OKFP, OKRe-FP, TOK-FP				
10 A	BiPOKS-PP				
4 A	OKPh				
12 A	RGLE13				





# Index of abbreviations

Index  
▲

<b>CI</b>	class
<b>AC or ac</b>	alternating current
<b>CT</b>	current transformer
<b>DC or dc</b>	direct current
<b>E</b>	energy
<b>Eact</b>	active energy
<b>Eapp</b>	apparent energy
<b>Ereact</b>	reactive energy
<b>FS</b>	full scale
<b>g</b>	acceleration of gravity (9.81 m/s <sup>2</sup> )
<b>Gb</b>	gigabyte
<b>HV</b>	high-voltage
<b>I</b>	current (A, kA)
<b>I/O</b>	input/output
<b>IEC</b>	International Electrotechnical Commission
<b>In</b>	nominal current
<b>IP</b>	protection level
<b>IR</b>	infrared
<b>K</b>	Kelvin temperature gradient
<b>Kb</b>	kilobyte
<b>LCD</b>	liquid crystal display
<b>LED</b>	light-emitting diode
<b>LV</b>	low voltage
<b>Mb</b>	megabyte
<b>min</b>	minute
<b>mm</b>	millimetre
<b>ms</b>	millisecond
<b>MV</b>	medium voltage
<b>NC</b>	“normally closed (“break” relay contact)”
<b>NO</b>	“normally open (“make” relay contact)”
<b>P</b>	active power (W, kW, MW)
<b>PC</b>	personal computer
<b>PF</b>	power factor
<b>PID</b>	proportional integral derivative
<b>PPM</b>	parts per million diameter (in mm)
<b>PR</b>	protection rating (often expressed as IP)
<b>Q</b>	reactive power
<b>R</b>	reading accuracy (in %)
<b>RMS</b>	root mean square
<b>S</b>	apparent power (in VA, kVA, MVA...)
<b>s</b>	second
<b>STN</b>	switched telephone network
<b>TC</b>	thermocouple
<b>THD</b>	total harmonic distortion
<b>TRMS</b>	True RMS
<b>U</b>	phase-phase voltage
<b>Un</b>	nominal voltage
<b>V</b>	phase-neutral voltage
<b>VT (or PT)</b>	voltage or potential transformer

# Index

<b>#</b>	μDIGI 1 .....	page 194
	μDIGI 2 .....	page 198
	76-2 .....	page 145
	77-2 .....	page 145
<b>A</b>	AC ammeter .....	page 224
	Analogue panel meters .....	page 218
	Analogue transducers .....	page 184
	Analyzers .....	page 78
<b>C</b>	C.A 2100 .....	Consult us
	C.A 2150 .....	page 202
	C.A 2200 .....	page 206
	C.A 3000 .....	Consult us
	Capacitor bank .....	Consult us
	CCT remote readable pulse receiver .....	page 66
	CDT remote readable meter .....	Consult us
	COHO .....	page 236
	Command function meter (analogue panel meter) .....	page 218
	Communication modules (for ULYS TDA80 - MD80 - TTA) .....	page 36
	Communication solutions .....	page 77
	Control relays .....	Consult us
	Current summation .....	page 141
	Current transformers .....	page 102
	CVAI .....	Consult us
	C.A 3420 .....	page 182
<b>D</b>	Data logger .....	page 56
	DC ammeter .....	page 232
	DC voltmeter .....	page 233
	Digital Panel meters .....	page 188
	Digital transducers .....	page 152
<b>E</b>	Electrical power quality analyzers .....	page 78
	ELOG .....	page 58
	Energy management (software) .....	page 68
	Energy meters .....	page 6
	Energy performance .....	page 4
	ENERIUM .....	page 38
	ENERTRACE .....	page 210
	E.ONLINE .....	page 68



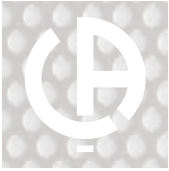

# Index

Index  
▲

E.QUAL PREMIUM	page 92
E.QUAL PREMIUM SERVER	page 92
E.SET	page 49
E.VIEW	page 50
E.VIEW+	page 51
<b>F</b> Flashing relays	Catalog 906 130 103
Frequency meters	page 227
Function relays	Catalog 906 130 103
<b>G</b> Graphic recorder	page 210
<b>H</b> Harmonic filters	Consult us
Hour meter	page 236
<b>I</b> Instantaneous relays	Catalog 906 130 103
<b>J</b> JYM 15	page 141
JVO	page 125
JVP	page 128
JVR	page 124
JVS	page 130
<b>L</b> LK	page 237
LOGIC	Consult us
<b>M</b> Management and analysis software	page 68
MAP	page 78
Maximum demand ammeter	page 228
MD65	page 24
MD80	page 26
Measurement and instrumentation	page 101
Measurement current transformers	page 102
MEMO 3	page 20
MEMO 4	page 22
Metering solutions	page 52
MICAR 2	page 174
MID	page 16
MODUL'M	Consult us
Modular energy meter	page 6
MODULIC analogue transducers	Consult us
Monostable instantaneous relays	Catalog 906 130 103
Multi-display units	Consult us

<b>N</b>	Network analyzers .....	page 78
	Network analyzer software .....	page 92
	Network quality .....	page 78
	NODUS .....	Consult us
	NORMEUROPE .....	page 222
<b>P</b>	Phase meters .....	pages 188, 218
	POWER .....	Consult us
	Power factor correction .....	Consult us
	Power monitors .....	page 38
	Probe (thermocouple) .....	See Pyrocontrole Catalog
	Process recorder .....	page 210
	Protection relays .....	Consult us
	PRTC .....	page 142
	Pulse receiver .....	page 66
<b>Q</b>	Quality analyzers .....	page 78
	QUAL-SRT .....	page 92
	QUAL-VIEW .....	page 92
<b>R</b>	RecDisplay .....	Consult us
	Recorder .....	page 210
	Relays .....	Catalog 906 130 103
	Relay sockets .....	Catalog 906 130 103
	Remote data retrieval solutions .....	page 56
	Remote-readable pulse receiver .....	page 56
	RENOV ENERGY .....	page 52
<b>S</b>	SESAME Programming software .....	Consult us
	SHEL .....	page 149
	SHMI .....	page 147
	SHMO .....	page 150
	Shunts .....	page 144
	Software	
	for ENERIUM .....	page 48
	for meter and power monitor .....	page 68
	for network analyzer .....	page 92
	for transducer .....	page 172
	for TRIAD2 .....	page 172
	energy management .....	page 68
	network supervision .....	page 68
	Split core transformers .....	page 118
	Switches .....	Consult us
	Synchrocoupleur .....	page 214
	Synchronization instruments .....	pages 18, 218
	Synchronizers .....	pages 188, 218



# Index

## Index ▲

<b>T</b>	Tachometric movement sensor.....	Consult us
	TC CLIP.....	page 112
	TCR current transformers.....	page 113
	TCRO current transformers.....	page 118
	TCS.....	Consult us
	TD80.....	page 28
	TDA80.....	page 32
	Timer.....	page 190
	TONIC.....	Consult us
	Transducers.....	page 152
	Transformers.....	page 102
	Transformer short-circuit switch.....	page 142
	TRI500.....	page 139
	TRI700.....	page 140
	TRIAD 2.....	page 158
	TRIADJUST 2 software.....	page 172
	T82 analogue transducers.....	Consult us
	TSPU/TSPI.....	page 185
	TSP2.....	page 184
	TT.....	page 30
	TTA.....	page 34
<b>U</b>	ULYS.....	page 6
	ULYSCOM.....	page 36
<b>V</b>	Varmeters.....	page 229
	VISUALL.....	Consult us
	Voltmeters.....	pages 188, 218
<b>W</b>	Wattmeters/Varmeters.....	page 229
	Web-box data logger.....	page 58



#### CHAUVIN ARNOUX

**Test et Mesure**  
190, rue Championnet  
75876 PARIS Cedex 18  
FRANCE  
Tél. : +33 1 44 85 44 85  
Fax : +33 1 46 27 73 89  
info@chauvin-arnoux.fr  
www.chauvin-arnoux.com



#### PYROCONTROLE

6 bis, av du Docteur Schweitzer  
69881 MEYZIEU Cedex  
FRANCE  
Tél. : +33 4 72 14 15 40  
Fax : +33 4 72 14 15 41  
info@pyrocontrole.com  
www.pyrocontrole.com



#### MANUMESURE

45 route de Saint Eugène  
14130 REUX  
FRANCE  
Tél. : +33 2 31 64 51 00  
Fax : +33 2 31 64 51 52  
info@manumasure.fr  
www.manumasure.fr

## 10 SUBSIDIARIES WORLDWIDE

#### AUSTRIA

**Chauvin Arnoux Ges.m.b.H**  
Slamastrasse 29/2/4  
1230 WIEN  
Tel.: +43 1 61 61 9 61  
Fax: +43 1 61 61 9 61-61  
vie-office@chauvin-arnoux.at  
www.chauvin-arnoux.at

#### CHINA

**Shanghai Pu-Jiang  
Enerdis Instruments Co. Ltd**  
3 Floor, Building 1  
N° 381 Xiang De Road  
200081 SHANGHAI  
Tel.: +86 21 65 21 51 96  
Fax: +86 21 65 21 61 07  
info@chauvin-arnoux.cn

#### GERMANY

**Chauvin Arnoux GmbH**  
Ohmstraße 1  
77694 KEHL / RHEIN  
Tel.: +49 07851 99 26-0  
Fax: +49 07851 99 26-0  
info@chauvin-arnoux.de  
www.chauvin-arnoux.de

#### ITALY

**AMRA SpA**  
Via Sant' Ambrogio, 23  
20846 MACHERIO (MB)  
Tel.: +39 039 245 75 45  
Fax: +39 039 481 561  
info@amra-chauvin-arnoux.it  
www.chauvin-arnoux.it

#### MIDDLE EAST

**Chauvin Arnoux Middle East**  
PO Box 60-154  
1241 2020 JAL EL DIB  
(Beirut) - LEBANON  
Tel.: +961 1 890 425  
Fax: +961 1 890 424  
camie@chauvin-arnoux.com  
www.chauvin-arnoux.com

#### SPAIN

**Chauvin Arnoux Iberica SA**  
C/ Roger de Flor N°293, 1a Planta  
08025 BARCELONA  
Tel.: +34 902 20 22 26  
Fax: +34 93 459 14 43  
comercial@chauvin-arnoux.es  
www.chauvin-arnoux.es

#### SCANDINAVIA

**CA Mätssystem AB**  
Sjöflygvägen 35  
SE-183 62 TABY  
Tel.: +46 8 50 52 68 00  
Fax: +46 8 50 52 68 10  
info@camatsystem.com  
www.camatsystem.com

#### SWITZERLAND

**Chauvin Arnoux AG**  
Moosacherstrasse 15  
8804 AU / ZH  
Tel.: +41 44 727 75 55  
Fax: +41 44 727 75 56  
info@chauvin-arnoux.ch  
www.chauvin-arnoux.ch

#### UNITED KINGDOM

**Chauvin Arnoux Ltd**  
Unit 1 Nelson Ct, Flagship Sq  
Shaw Cross Business Pk, Dewsbury  
West Yorkshire - WF12 7TH  
Tel:+44 1924 460 494  
Fax: +44 1924 455 328  
info@chauvin-arnoux.co.uk  
www.chauvin-arnoux.com

#### USA

**Chauvin Arnoux Inc  
d.b.a AEMC Instruments**  
200 Foxborough Blvd.  
Foxborough - MA 02035  
Tel.: +1 (508) 698-2115  
Fax: +1 (508) 698-2118  
sales@aemc.com  
www.aemc.com

#### ENERDIS

**A local service  
for a better service**

A centralized contact

#### ENERDIS

16, rue Georges Besse - Silic 44  
92182 ANTONY Cedex  
FRANCE  
www.enerdis.com

#### France

Tel.: 01 75 60 10 30  
Fax: 01 46 66 62 54  
info@enerdis.fr

#### International

Tel.: +33 1 75 60 10 30  
Fax: +33 1 46 66 62 54  
export@enerdis.fr



See the complete **automation relays** offering to meet all the requirements of industry, the energy sector, rail, etc.